

QO[®] Loadcentres and Circuit Breakers

Enclosure Dimensions

DE1 LOAD CENTRES

Type 1 QO Loadcentre Enclosures

Type 1 Box Size	Height (in./mm)	Width (in./mm)	Depth (in./mm)
1	5.50/140	3.00/76	3.50/89
2	6.75/171	3.75/95	3.00/76
3	9.25/235	4.75/121	3.25/83
4	12.75/324	9.00/229	3.75/95
5	13.25/377	6.00/152	3.50/89
6	15.00/381	14.25/362	3.75/95
7	18.00/457	14.25/362	3.75/95
8	21.00/533	14.25/362	3.75/95
9	26.25/667	14.25/362	3.75/95
10	30.00/762	14.25/362	3.75/95
11	34.00/864	14.25/362	3.75/95
12	38.00/965	14.25/362	3.75/95
13	40.00/1016	14.25/362	3.75/95
14	41.25/1048	14.25/362	3.75/95

Type 3R QO Loadcentre Enclosures

Type 3R Box Size	Height (in./mm)	Width (in./mm)	Depth (in./mm)
1NM	9.80/245	6.5/162.5	3.9/97.5
1RB	9.50/241	5.00/127	4.00/102
2RB	12.75/324	9.00/229	4.25/108
3RB	13.00/330	6.75/171	4.00/102
4RB	19.00/483	14.25/362	4.50/114
5RB	22.00/559	14.25/362	4.50/114
6RB	22.25/565	14.25/362	4.50/114
7RB	30.00/762	14.25/362	4.50/114
8RB	34.00/864	14.25/362	4.50/114
9RB	38.00/965	14.25/362	4.50/114

Recreational Vehicle Park Loadcentres

Box Size	Height (in./mm)	Width (in./mm)	Depth (in./mm)
RVP1	8.50/216	7.75/197	5.80/147
RVP2	16.40/417	7.75/197	5.80/147
Pedestal	50.90/129	7.60/193	3.50/89

Mobile Home and Trailer Loadcentres

Box Size	Height (in./mm)	Width (in./mm)	Depth (in./mm)
MH1	6.72/171	3.81/97	3.00/76
MH2	9.30/236	4.80/122	3.19/81
MH3	12.57/319	8.88/226	3.80/97

Application Information

- Dimensions for approximate only. Do not use for construction.

Canadian HomeLine® Circuit Breakers and Loadcentres

General Information

Canadian HomeLine™ Single Phase Loadcentres

DE1
LOAD CENTRES

- Pages:**
- DE1-17 to DE1-34
- Application:**
- Residential, Light Commercial
 - 30 through 225 Amperes
- Standards:**
- CSA Certified under File #LL-89066
- Enclosures:**
- Type 1 and 3R
- Features:**
- One piece, plated, shielded aluminum bus
 - Split branch neutral with 3-1/0 "built in" branch neutral lugs
 - Combination Slot/Robertson neutral, ground and trim screws
 - Additional ground bar provisions
 - Trims have automatic flush adjustment
 - Fusible loadcentre inserts (HFLCI)
- Accessories:**
- Secondary Surge Arresters
 - Sub-Feed Lugs
 - Filler Plates (for branch and main breakers)
 - Door Lock Kits
 - Neutral Lugs
 - Neutral extension kits



Canadian HomeLine™ Circuit Breakers and Loadcentres

Product Description

DE1 LOAD CENTRES



HomeLine™ Main Breaker Loadcentre



Flush Cover

The Residential Solution for Canadian Electrical Contractors

HomeLine™ circuit breaker loadcentres from Schneider Electric are CSA certified panelboards. They are designed to meet residential requirements to protect electrical systems, equipment, and people.

Features

Indoor (NEMA Type 1), Main Breaker, 12 to 60 spaces

- Single phase, 120/240V
- 200A maximum tin plated aluminum bus
- 60 spaces, 120 circuits max
- Short circuit rating
 - standard 22kAIC – main breaker (50A thru 200A)
 - series ratings up to 100kAIC
- Distributed neutral bar design
- Robertson/Slot neutral, ground and trim screws
- Shielded bus bar
- Appliance white combination flush/surface mount trim
- Automatic flush trim adjustment with shutter type twistouts
- Top or bottom feed
- Multiple horizontal and vertical ground bar mounting positions
- Straight in wiring for main and branch wiring
- Removable interiors
- Tangential main knockouts
- Provision for optional door lock
- Welded box construction

Indoor (NEMA Type 1), Main Lug, 2 to 42 spaces

- Single phase, 120/240V
- 225A maximum tin plated aluminum bus
- 42 spaces, 84 circuits max
- Short circuit rating
 - standard 10kAIC – main lug
 - series ratings up to 100kAIC
- Robertson/Slot neutral, ground and trim screws
- 2 to 6 space single row loadcentres, ASA49 grey
- Top or bottom feed
- Welded box construction

HomeLine Fusible Loadcentre Inserts (HFLCI)

Indoor (NEMA Type 1), Main Lug, 12 spaces

- Single phase, 120/240V
- 125A maximum tin plated aluminum bus
- 12 spaces, 24 circuits max
- Short circuit rating
 - standard 10kAIC
 - series ratings up to 100kAIC
- Robertson/Slot neutral, ground and trim screws
- Architectural white surface mount trim with door

Outdoor (NEMA Type 3R), Main Breaker, 8 to 20 spaces

- Single phase, 120/240V
- 200A maximum tin plated aluminum bus
- 20 spaces, 40 circuits max
- Short circuit rating
 - standard 22kAIC – main breaker
 - series ratings up to 100kAIC
- Distributed neutral bar design
- Robertson/Slot neutral, ground and trim screws
- Shielded bus bar
- Side hinged door
- Welded, galvanealed steel, painted ASA49 grey enclosure
- Gasketless rain hubs – 0.75" to 2.5"
- Stainless steel locking hasp



RB Device

Outdoor (NEMA Type 3R), Main Lug, 2 to 12 spaces

- Single phase, 120/240V
- 125A maximum tin plated aluminum bus
- 12 spaces, 24 circuits max
- Short circuit rating
 - standard 10kAIC – main lug
 - series ratings up to 100kAIC
- Robertson/Slot neutral, ground and trim screws
- Welded, galvanealed steel, painted ASA49 grey enclosure
- Gasketless rain hubs – 0.75" to 2.5"
- Stainless steel locking hasp



Bolt-On Hubs

Canadian HomeLine™ Circuit Breakers and Loadcentres

General Information and Application Data



CHOM 1-Pole
1 space required.



CHOM 2-Pole
2 spaces required.



CHOMT 1-Pole Tandem
1 space required.



CHOMT Quad Circuit Breaker
2 spaces required.

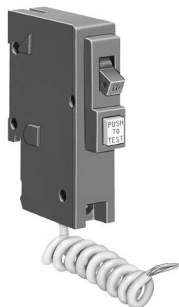

CHOM 1-Pole GFI
1 space required.



CHOM 2-Pole GFI
2 space required.



CHOM-AFI
1 space required.



QOM2 Frame Size



QOM1 Frame Size

Main breakers, branch breakers and surge suppressors

- CSA File # LL-89066
- Accepts 60/75C wire up to 40A, 75C wire over 40A
- HACR rated
- SWD rating on 1" 15A and 20A breakers
- 1-pole and 2-pole
- Standard – 1" per pole
- Twin – 1/2" per pole
- Quad – 1/2" per pole
- Main breakers
 - 30A thru 225A
- Branch breakers
- 15A thru 200A
- Optional high magnetic on 1" 15A and 20A breakers
- Subfeed lugs
 - 125A or 225A
- Arc-fault circuit interrupters – 20A max
- Combination arc-fault circuit interrupters – 20A max
 - Senses series and parallel arcing
- Ground fault circuit interrupters – 50A max
 - 5mA Class A
 - 30mA equipment protective devices
- Spa packs
- Accessories
 - handle lock offs
 - handle ties
 - branch filler plates
- Plug-in surge suppressors
 - Electronic MOV technology
 - Plug-in or knockout mounted

Branch Circuit Breakers

10,000 AIR	
CHOM	1-pole, 15–50 A
	2-pole, 15–200 A
CHOMT	1-pole, 15–30 A
	2-pole, 15–50 A
CHOM-GFI	1-pole, 15 & 20 A
	2-pole, 15, 20, 30, 40, 50 A
CHOM-AFI	1-pole, 15 & 20 A
CHOM-CAFI	1-pole & 2 pole, 15 & 20 A
CHOM-DF	1-pole, 15 & 20 A

Canadian HomeLine™ Circuit Breakers and Loadcentres

Product Description

Canadian Catalogue Number logic
HomeLine™ Loadcentres

Number Segment	Character	Description	CHOM	3060	L	200	G	—	C
Load Center Family	CHOM	CSA Listed							
Spaces / Circuits	3060								
Mains Type	M	Main circuit breaker							
	L	Main lugs							
Amps									
Ground Bar	G	Factory included							
Cover	C	Combination flush / surface indoor cover							
	F	Flush							
	RB	Rainproof							
	S	Surface							

HomeLine™ Circuit Breakers

Number Segment	Character	Description	CHOM	1	15	—
Brand	CHOM	Full Size				
	CHOMT	Tandem/Quad				
Number of Poles						
Amps						
Device Name	AFI	Arc fault circuit interruption				
	BB	High amp branch breaker				
	CAFI	Combination arc fault circuit interruption				
	EPD	Equipment protection device, 30mA				
	GFI	Ground fault circuit interruption, 5mA				
	HM	High magnetic trip				
	DF	Dual function				

Notes:

1. CHOM 1pole - 1" wide, 1 space required.
2. CHOM 2pole - 2" wide, 2 spaces required.
3. CHOMT 1pole tandem - 1" wide, 1 space required, represents two 1pole circuit breakers, i.e. CHOMT1515.
4. CHOMT 2pole tandem quad - 2" wide, 2 spaces required, represents two 1pole outer poles and one 2pole inner circuit breaker with common trip, i.e. CHOMT1515220.

Canadian HomeLine[®] Circuit Breakers and Loadcentres

Circuit Breakers and Accessories

DE1 LOAD CENTRES

Standard and Main Circuit Breakers

Standard Loadcentre Breakers

Type	Amp Rating	1 Pole Cat. No.	Lug Range	2 Pole Cat. No.	Lug Range
CHOM 1, 2 & 4	15	CHOM115	#14 - #8	CHOM215	#14 - #8
	20	CHOM120		CHOM220	
	25	CHOM125		CHOM225	
	30	CHOM130		CHOM230	
	35	—	CHOM235	#8-#2	
	40	CHOM140	CHOM240		
	45	—	—		
CHOM 5 high magnetic	50	CHOM150	#8-#2	CHOM250	#8-#2
	15	CHOM115HM	#14-#8	—	#8-#2
20	CHOM120HM	—			
CHOM 1 & 3	60	—	—	CHOM260	#4-2/0
	70	—		CHOM270	
	80	—		CHOM280	
	90	—		CHOM290	
	100	—	—	CHOM2100	#4-300mcm
	125	—		CHOM2125	
	150	—		CHOM2150BB	
	175	—		CHOM2175BB	
200	—	CHOM2200BB			

Notes:

1. All CHOM 1 & 2 pole CSA listed as HACR type.
2. CHOM115 & 120 SWD rated.
3. CHOM2P150-2P200 require 4 spaces, use only in single phase loadcentres rated 150A or greater.
4. CHOM 1pole circuit breakers require one space. CHOM 2pole circuit breakers require two spaces.
5. High magnetic trip circuit breakers are recommended for applications where high initial inrush current may occur.

HomeLine Main Circuit Breakers

Type	Amp Rating	2 Pole Cat No.	kAIC	Lug Range
QOM1	30	QOM30L	10	#12-2/0
	40	QOM40L	10	
	50	QOM50VHL	22	
	60	QOM60VHL		
	70	QOM70VHL		
	80	QOM80VHL		
	100	QOM100VHL		
QOM2	125	QOM125VHL		#4-300mcm
	100	QOM2100VHL		
	125	QOM2125VHL		
	150	QOM2150VHL		
	175	QOM175VHL		
	200	QOM2200VHL		
	225	QOM2225VHL		



QOM2

Canadian HomeLine™ Circuit Breakers and Loadcentres Circuit Breakers and Accessories

CHOMT Breakers, Combination Arc Fault Circuit Interrupters, Dual Function Circuit Breakers

HOME LINE
DE1

CHOMT Tandem & Quad Tandem Circuit Breakers

Type	Amp Rating		CHOMT Tandem Cat. No.	Lug Range
CHOMT Tandem 1 & 3	15-15		CHOMT1515	15-30A #14-#8
	15-20		CHOMT1520	
	20-20		CHOMT2020	
	30-15		CHOMT3015	
	30-20		CHOMT3020	
CHOMT Quad Tandem 1, 2 & 4	1P	2P	Quad CHOMT Tandem Cat. No.	15-30A #14-#8
	(2)15A	15A	CHOMT1515215	
	(2)15A	20A	CHOMT1515220	
	(2)15A	25A	CHOMT1515225	
	(2)15A	30A	CHOMT1515230	
	(2)15A	40A	CHOMT1515240	40-50A #6-12 Al #6-14 Cu
	(2)15A	50A	CHOMT1515250	
	(2)20A	20A	CHOMT2020220	
	(2)20A	25A	CHOMT2020225	
	(2)20A	30A	CHOMT2020230	
	(2)20A	40A	CHOMT2020240	
	(2)20A	50A	CHOMT2020250	

Notes:

1. CSA certified for use as HACR type circuit breakers.
2. Cat# represents two 1P outer poles and one 2P inner circuit breaker with common trip.
3. CHOMT tandems require 1 space.
4. CHOMT quad tandems require 2 spaces.

HomeLine Combination Arc-Fault Interrupter (CAFI)

HomeLine Combination Arc-Fault Interrupter (CAFI) provides overload and short circuit protection, plus both series and parallel type arc protection as required in 2015 CEC. Integrated with Time Saver diagnostics, HomeLine CAFI breaker improves circuit troubleshooting at the touch of a button.

Circuit Breaker Type	Ampere Rating	1P 120 Vac 10K AIR 1 Space Required	2P 120/240 Vac 10K AIR 2 Space Required
HomeLine Pigtail Neutral CAFI	15	CHOM115CAFI	CHOM215CAFI*
	20	CHOM120CAFI	CHOM220CAFI*
HomeLine Plug-on Neutral CAFI	15	CHOM115PCAFI	
	20	CHOM120PCAFI	

* Rated for 120/240V ~ 60 Hz, not for 208Y/120V

HomeLine Dual Function Circuit Breaker

HomeLine Dual Function (DF) breaker provides both combination arc-fault and ground-fault (5mA classA) protection in a single compact device. Integrated with Plug-on Neutral and Time Saver Diagnostics features, HomeLine DF breaker offers maximum circuit protection and installation flexibility.

Circuit Breaker Type	Ampere Rating	1P 120 Vac 10K AIR 1 Space Required
		Catalog Number
HomeLine Dual Function Circuit Breaker with Pigtail Neutral	15	CHOM115DF
	20	CHOM120DF
HomeLine Plug-on Neutral Dual Function Circuit Breaker	15	CHOM115PDF
	20	CHOM120PDF

Canadian HomeLine™ Circuit Breakers and Loadcentres

Circuit Breakers and Accessories

DE1 LOAD CENTRES

Ground Fault Circuit Interrupters, Arc Fault Circuit Interrupters

HomeLine GFI with 5 mA Sensitivity (Class A)

Amp Rating	1 Pole Cat. No.	2 Pole Cat. No.
15	CHOM115GFI	CHOM215GFI
20	CHOM120GFI	CHOM220GFI
30		CHOM230GFI
40		CHOM240GFI
50		CHOM250GFI

Ground Fault Devices (GFI)

Spa Pack

A complete kit consisting of a Type 3R enclosure, factory installed 2P50A GFCI circuit breaker.

Spa Pack

Amp Rating	Poles	Cat. No.
50	2	CHOME250SPA

HomeLine EPD with 30 mA Sensitivity

Type	1 Pole Cat. No.	2 Pole Cat. No.
15	CHOM115EPD	CHOM215EPD
20	CHOM120EPD	CHOM220EPD
30		CHOM230EPD
40		CHOM240EPD
50		CHOM250EPD

Notes:

- GFI breakers maximum 250 feet (one way) feeder length
- Use solid conductor only when #14 wire is used



CHOM115GFI



CHOM230GFI



CHOM115PCAFI



CHOM215CAFI



CHOM115CAFI

Canadian HomeLine Breaker Accessories

Description	Cat. No.
Handle attachments	
Handle tie, converts any 2 adjacent 1P HOM circuit breakers to independent trip 2P	HOM1HT
Handle tie, converts any adjacent 1P side by side HOMT CB's to independent 2P	HOMTHT
Handle lock, ON or OFF, nonpadlocking HomeLine 1p 15-50A CB	QO1LO
Handle blocking device, attaches to a HOM 2P CB for holding the handle in the OFF position	HOM2HBD
Handle lock, ON or OFF, padlocking HomeLine 1p 15-50A CB	HOM1PA
2 pole standard HomeLine handle lock ON or OFF, Padlocking	
- Handle padlock attachment, for padlocking 2P 15-70A	HOM2PALA
- Handle padlock attachment, for padlocking 2P 80-125A	HOM2PAHA
- Handle padlock attachment, for padlocking 2P 150-200A	HOM2PAVHA
Handle Padlock Attachment, for padlocking 1P CAFI,DF, GFI, and EPD CHOM breakers in ON or OFF position	HOMELEC1PA
Handle Padlock Attachment, for padlocking 2P CAFI, GFI, and EPDC CHOM breakers in ON or OFF position	HOMELEC2PALA
Handle padlock attachment, for padlocking centre poles of HOM quad breakers in the OFF position	HOMQPA
Handle lock, OFF for QOM1 50-125A Main Circuit Breaker	QOM1PA
Handle lock, OFF for QOM2 100-225A Main Circuit Breaker	QOM2PA
Sub-feed Lugs	
125A 2P plug-on - 2 spaces required	HOML2125
225A 2P plug-on - 4 spaces required	HOML2225

Note: Canadian HomeLine and QO loadcentre accessories may

Canadian HomeLine™ Circuit Breakers and Loadcentres

Type 1 Main Lug and Main Circuit Breaker Loadcentres

Single-Phase, Three-Wire, 120/240 Vac Main Lugs – Indoor

Mains Rating in Amps	Loadcentre Catalogue Number	Maximum Number of Circuits		Loadcentre Cover Catalogue Number	Service Entrance Approved	Maximum Short Circuit Rating	Main Wire Size AWG/kcmil Al/Cu	Enclosure No. (Pages 34-35)	Top or Bottom Mains Position
		Standard 1"	Tandem or Quad						

Factory-Installed Main Lugs

70	CHOM24L70F/S	2	4	Included	N	10,000 A	#12-3 #14-4	2	Top
100	CHOM612L100F/S	6	12	Included	N	10,000 A	#8-1	4	Top
125	CHOM48L125GC	4	8	Included	N	10,000 A	#4-2/0	21	Top

Factory-Installed Main Lugs

125	CHOM816L125GC	8	16	Included	N	10,000 A	#6-2/0	6	Both
	CHOM1224L125GC	12	24	Included	N	10,000 A	#6-2/0	6	Both
	CHOM1632L125GC	16	32	Included	N	10,000 A	#6-2/0	8	Both
	CHOM2448L125GC	24	48	Included	N	10,000 A	#6-2/0	8	Both
	CHOM3060L125GC	30	60	Included	N	10,000 A	#6-2/0	10	Both

Factory-Installed Main Lugs

225	CHOM3060L225GC	30	60	Included	N	10,000 A	#6-250	10	Both
	CHOM4284L225GC	42	84	Included	N	10,000 A	#6-250	12	Both

Single-Phase, Three-Wire, 120/240 Vac Main Circuit Breaker – Indoor

Mains Rating in Amps	Loadcentre Catalogue Number	Maximum Number of Circuits		Loadcentre Cover Catalogue Number	Service Entrance Approved	Maximum Short Circuit Rating	Main Wire Size AWG/kcmil Al/Cu	Enclosure No. (Pages 34-35)	Top or Bottom Mains Position
		Standard 1"	Tandem or Quad						

Factory-Installed Main Circuit Breaker

30	CHOM1224M30GC	12	24	Included	Y	10,000 A	#6-2/0	6	Both
50	CHOM1224M50GC	12	24	Included	Y	22,000 A	#6-2/0	6	Both
60	CHOM1224M60GC	12	24	Included	Y	22,000 A	#6-2/0	6	Both
	CHOM1632M60GC	16	32	Included	Y	22,000 A	#6-2/0	7	Both
70	CHOM1224M70GC	12	24	Included	Y	22,000 A	#6-2/0	6	Both
	CHOM1632M70GC	16	32	Included	Y	22,000 A	#6-2/0	7	Both
100	CHOM1224M100GC	12	24	Included	Y	22,000 A	#6-2/0	6	Both
	CHOM1632M100GC	16	32	Included	Y	22,000 A	#6-2/0	7	Both
	CHOM2448M100GC	24	48	Included	Y	22,000 A	#6-2/0	8	Both
	CHOM3060M100GC	30	60	Included	Y	22,000 A	#6-2/0	10	Both
125	CHOM1224M125GC	12	24	Included	Y	22,000 A	#6-2/0	6	Both
	CHOM1632M125GC	16	32	Included	Y	22,000 A	#6-2/0	8	Both
	CHOM2448M125GC	24	48	Included	Y	22,000 A	#6-2/0	8	Both
	CHOM3060M125GC	30	60	Included	Y	22,000 A	#6-2/0	10	Both

Factory-Installed Main Circuit Breaker

100	CHOM3060M2100GC	30	60	Included	Y	22,000 A	#4-250	10	Both
	CHOM4284M2100GC	42	84	Included	Y	22,000 A	#4-250	12	Both
	CHOM60120M2100GC	60	120	Included ●	Y	22,000 A	#4-250	24	Both
150	CHOM2040M150GC	20	40	Included	Y	22,000 A	#4-250	9	Both
	CHOM3060M150GC	30	60	Included	Y	22,000 A	#4-250	10	Both
	CHOM60120M150GC	60	120	Included ●	Y	22,000 A	#4-250	24	Both
200	CHOM2040M200GC	20	40	Included	Y	22,000 A	#4-250	9	Both
	CHOM3060M200GC	30	60	Included	Y	22,000 A	#4-250	10	Both
	CHOM4284M200GC	42	84	Included	Y	22,000 A	#4-250	12	Both
	CHOM60120M200GC	60	120	Included ●	Y	22,000 A	#4-250	24	Both

● Does not include a door. Order kit # CHOMDK602.

- Main Breaker loadcentres are approved for service entrance use. The main breaker compartment can be sealed and the main breaker can be locked.
- All type 1 loadcentres are approved for vertical, horizontal, or inverted mounting.
- Canadian HomeLine loadcentres 8/16-space and above (double-row construction) come with Plug-on Neutral capability as standard.

Canadian HomeLine™ Circuit Breakers and Loadcentres

Type 3R Main Lug and Main Circuit Breaker Loadcentres

DE1 LOAD CENTRES

Single-Phase, Three-Wire, 120/240 Vac Main Lugs – Rainproof

Mains Rating in Amps	Loadcentre Catalogue Number	Maximum Number of Circuits		Loadcentre Cover Catalogue Number	Service Entrance Approved	Maximum Short Circuit Rating	Main Wire Size AWG/kcmil Al/Cu	Enclosure No. (Pages 34-35)	Top or Bottom Mains Position
		Standard 1"	Tandem or Quad						

Factory-Installed Main Lugs

70	CHOM24L70RB	2	4	Included	N	10,000 A	#12-3 Al #14-4 Cu	1R	Top
100	CHOM612L100RB	6	12	Included	N	10,000 A	#8-1	2R	Top
125	CHOM48L125GRB	4	8	Included	N	10,000 A	#12-2/0 Al #14-2/0 Cu	15R	Top

Factory-Installed Main Lugs

125	CHOM816L125GRB	8	16	Included	N	10,000 A	#6-2/0	3R	Top
	CHOM1224L125GRB	12	24	Included	N	10,000 A	#6-2/0	3R	Top

Single-Phase Three Wire 120/240 Vac Main Breaker – Rainproof

Factory-Installed Main Circuit Breaker

100	CHOM816M100GRB	8	16	Included	Y	22,000 A	#6-1	3R	Top
	CHOM1224M100GRB	12	24	Included	Y	22,000 A	#6-2/0	3R	Top

Factory-Installed Main Circuit Breaker

200	CHOM2040M200GRB	20	40	Included	Y	22,000 A	#4-250	6R	Top
-----	-----------------	----	----	----------	---	----------	--------	----	-----

- Canadian HomeLine loadcentres 8/16-space and above (double-row construction) come with Plug-on Neutral capability as standard.

Fusible Loadcentre Inserts



Step #1
**Identify Box Dimensions and
Catalogue Number**

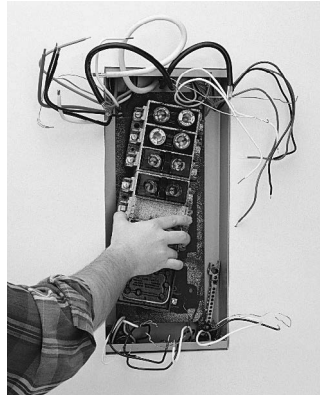

Step #2
**Remove Old Fusible
Interior**



Step #3
Install New HFLCI



Step #4
Complete Installation

- HomeLine Fusible Loadcentre Inserts (HFLCI) offer the safety and reliability of a modern circuit breaker loadcentre system featuring HomeLine circuit breakers.
- Easily replaces outdated fusible loadcentres.
- Eliminates drywall removal and repair.
- Eliminates painting new drywall.
- No holes to drill.
- No new ground required.
- No branch conductors or conduit to remove.
- Using the HomeLine FLCI substantially reduces installation time, as much as 80%, allowing for the economical replacement of old fusible loadcentres.

Canadian HomeLine™ Circuit Breakers and Loadcentres

Loadcentres

HomeLine Fusible Loadcentre Inserts (HFLCI)

READ THIS FIRST!

To select the proper HFLCI, follow these three steps:

- Step 1: Find your fusible loadcentre catalogue number using columns 1 and 2.
 Step 2: Confirm that the original fusible loadcentre box dimensions match those in columns 5, 6, and 7.
 Step 3: Use column 3 to identify the HomeLine Fusible Loadcentre Insert (HFLCI) catalogue number.

CAUTION: Do not proceed with an installation unless both the existing catalogue number and box dimensions match.

1 Original Manufacturer	2 Original Main Lug Loadcentre Catalogue Number	3 HomeLine Catalogue Number**	4 Maximum Number of Circuits		5 6 7 Box Dimensions					
					Height		Width		Depth	
					Standard 1"	Tandem or Quad	Inches	mm	Inches	mm
Amalgamated Electric	4208	HFLCI12D	6	12	16.126	410	8.506	216	2.813	72
Amalgamated Electric	4212	HFLCI16D	8	16	19.506	496	8.506	216	2.813	72
Amalgamated Electric	4220	HFLCI20AD	10	20	24.256	616	8.506	216	2.813	72
Amalgamated Electric	4220	HFLCI24AD	12	24	24.256	616	8.506	216	2.813	72
Amalgamated Electric	4216	HFLCI20BD	10	20	23.126	587	8.506	216	2.813	72
Amalgamated Electric	4216	HFLCI24BD	12	24	23.126	587	8.506	216	2.813	72
Amalgamated Electric	4312	HFLCI20BD	10	20	23.126	587	8.506	216	2.813	72
Amalgamated Electric	4312	HFLCI24BD	12	24	23.126	587	8.506	216	2.813	72
CEB	NHP10-634	HFLCIC16BD	8	16	20.126	511	7.876	200	3.063	78
CEB	NHP10-636-3	HFLCIC20BD	10	20	24.126	613	10.126	257	3.063	78
CEB	NHP10-636-3	HFLCIC20ED	10	20	27.876	708	10.251	261	3.063	78
CEB	NHP10-636-3	HFLCIC24BD	12	24	24.126	613	10.126	257	3.063	78
CEB	NHP12-60	HFLCIC12DD	6	12	20.126	511	7.876	200	3.063	78
CEB	NHP12-633	HFLCIC20AD	10	20	23.126	587	7.876	200	3.063	78
CEB	NHP12-633	HFLCIC24AD	12	24	23.126	587	7.876	200	3.063	78
CEB	NHP4-632	HFLCIC12BD	6	12	16.256	413	7.876	200	3.063	78
CEB	NHP4-632-1	HFLCIC16D	8	16	19.126	486	7.876	200	3.063	78
CEB	NHP4-633-1	HFLCIC16D	8	16	19.126	486	7.876	200	3.063	78
CEB	NHP6-60	HFLCIC12CD	6	12	13.876	353	7.876	200	3.063	78
CEB	NHP6-633-1	HFLCIC16BD	8	16	20.126	511	7.876	200	3.063	78
CEB	NHP6-636-4	HFLCIC16CD	8	16	24.126	613	7.876	200	3.063	78
CEB	NHP8-60	HFLCIC12D	6	12	16.256	413	7.876	200	3.063	78
CEB	NHP8-635-2	HFLCIC20AD	10	20	23.126	587	7.876	200	3.063	78
CEB	NHP8-635-2	HFLCIC24AD	12	24	23.126	587	7.876	200	3.063	78
Taylor (Crouse Hinds)	NHP0020	HFLCIT8AD	4	8	12.876	327	9.626	245	3.063	78
Taylor (Crouse Hinds)	NHP6-30-60	HFLCIT16AD	8	16	21.126	537	7.506	191	3.063	78
Taylor (Crouse Hinds)	NHP1231	HFLCIT20AD	10	20	24.626	626	9.626	245	3.063	78
Taylor (Crouse Hinds)	NHP20-0821-6	HFLCIT20AD	10	20	24.626	626	9.626	245	3.063	78

** HomeLine FLCI's include distribution section interior, trim, door and painted architectural white.

Note: Not suitable for use with Canadian HomeLine AFI, CAFI, DF or GFI devices.

Accessories

- Plug-in surge breaker
- Ground bars
- Neutral lugs
- Filler plates
- Type 3R rain hubs
- Type 3R coupling trough
- Door lock
- Main lugs
- Replacement covers
- Replacement interiors



RB Hub



BC200 Enclosure Coupling



CHOM Surgebreaker®
Surge Arrester
2 spaces required.



PK15GTA



PK6FL

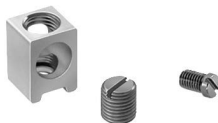

LK100AN



QOL125



HOMFP



QOM1FP



QOL225



QOM2FP

Canadian HomeLine™ Circuit Breakers and Loadcentres

HomeLine Loadcentre Accessories

Replacement Covers, 1 Phase, Type 1 Enclosures ONLY

Reference Loadcentre Catalogue Number	Replacement Cover Catalogue Number
CHOM24L70S *	4055800801
CHOM24L70RB	4056314401
CHOM24L70F *	4055800701
CHOM48L125GC	4055844801
CHOM48L125GRB	4056318650
CHOM612L100S *	4055801702
CHOM612L100F *	4055801801
CHOM612L100RB	4056318550
CHOM816M100GRB	4056319050
CHOM1224M100GRB	4056319050
CHOM2040M200GRB	4056319150
CHOM 8-16, 12-24 ML-MB loadcentres	CHOMC12UC
CHOM 16-32 60-100A MB loadcentres	CHOMC21UC
CHOM 16-32 125A, 24-48 ML-MB loadcentres	CHOMC24UC
CHOM 30-60 100-125A MB loadcentres	CHOMC30U125C
CHOM 30-60 150-225A ML-MB loadcentres	CHOMC30UC
CHOM 42-84 ML-MB loadcentres	CHOMC42UC
CHOM 20-40 MB loadcentres	CHOMC20UC

* No door on cover.

Door Lock Kits, 1 Phase, Type 1 Enclosures ONLY

Catalogue Number	Description
PK6FL	For use with type 1 Canadian HomeLine Loadcentres.

Surge Protective Device

Description	Catalogue Number
Surge arrester for 1PH3W system 150Vac maximum phase-to-ground	CHOM2175SB

Interchangeable Hubs

Conduit Size	Type B Hubs
Closing Plate	BCAP
3/4"	B075
1"	B100
1 1/4"	B125
1 1/2"	B150
2"	B200
2 1/2"	B250



B-150

Coupling Trough

Catalogue Number	Description
BC200	BC200 - enclosure coupling for RB devices

Filler Plates

Description	Catalogue Number
Branch Breaker	HOMFP
QOM1 Main Breaker	QOM1FP
QOM2 Main Breaker	QOM2FP

Optional Neutral Lugs

Wire Size	Catalogue Number
#12-2 AL #14-4 Cu	LK70AN
#6-2/0 AL/Cu	LK100AN
#14-2/0 AL/Cu	LK125AN
#2-3/0 AL/Cu	LK150AN

Main Lug Kits

Catalogue Number	Description
QOL125	125A Kit
QOL225	225A Kit

TECHNICAL INFORMATION

Grounding Bar Kits

instructions and an "Equipment Grounding Terminal" self-adhesive label.

All PK equipment grounding bar kits are supplied with mounting screws, necessary installation

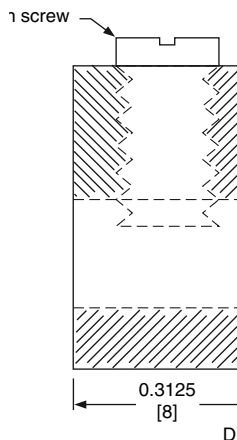

3 Section of Size 1 Ground

Catalogue Number	Total Qty.	Terminals						Approximate Overall Length		Distance Between Mounting Holes		Mounting
		Quantity Each Size See "Wire Range Table" below.										
		I	II	III	IV	V	VI	in	[mm]	in	[mm]	
PK0GTA2	2	—	—	—	—	—	2	1.75	[44]	One hole	One hole	Top
PK0GTA6	6	—	—	—	—	6	—	4.61	[117]	1.69	[43]	Top
PK3GTA1	3	3	—	—	—	—	—	1.38	[35]	One hole	One hole	Top
PK4GTA	4	4	—	—	—	—	—	1.63	[41]	One hole	One hole	Top
PK5GTA	5	5	—	—	—	—	—	2.25	[57]	1.25	[32]	Top
PK7GTA	7	7	—	—	—	—	—	2.88	[73]	1.25	[32]	Top or Side
PK9GTA1	9	9	—	—	—	—	—	3.25	[83]	One hole	One hole	Top
PK9GTA	9	9	—	—	—	—	—	3.78	[96]	3.13	[80]	Top
PK12GTA	12	12	—	—	—	—	—	4.70	[119]	3.13	[80]	Top
PK15GTA	15	15	—	—	—	—	—	5.63	[143]	3.13	[80]	Top
PK15GTAL	16	15	1	—	—	—	—	8.13	[207]	3.13	[80]	Top
PK15GTA6 ¹	21	15	—	—	6	—	—	5.88	[149]	∞ ²	²	Top
PK18GTA	18	18	—	—	—	—	—	6.56	[167]	3.13	[80]	Top
PK18GTAL	19	18	1	—	—	—	—	8.81	[224]	3.13	[80]	Top
PK23GTA	23	23	—	—	—	—	—	8.11	[206]	3.13	[80]	Top
PK23GTAL	24	23	1	—	—	—	—	9.44	[240]	3.13	[80]	Top
PK27GTA ³	27 or 26	27 or 26	—	1	—	—	—	9.36	[238]	3.13	[80]	Top

¹ Mounting screws 21594-14241(two required) and 21594-17121(two required).

² 3.13 in. (80 mm) on small terminals; 5.25 in. (133 mm) on large terminals.

³ PK27GTA includes one main grounding lug that mounts with two terminal screws and requires three terminals for mounting.

Wire Range Table

Size	Cu (AWG)	Al (AWG)
I	(1) #14-#4 or (2) #14 or #12	(1) #12-#4 or (2) #12 or #10
II	(1) #1-4/0	(1) #1-4/0
III	(1) #6-2/0	(1) #6-2/0
IV	(1) #6-3/0	(1) #6-3/0
V	(1) #14-1/0	(1) #14-1/0
VI	(1) #10-2/0	(1) #6-2/0

Canadian HomeLine™ Circuit Breakers and Loadcentres Wiring Diagrams

WIRING DIAGRAMS

DE1 LOAD CENTRES



CHOM24L70S/F
CHOM24L70RB

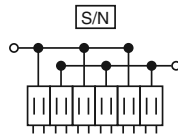

CHOM612L100S/F
CHOM612L100RB

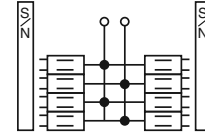

CHOM816L125GC
CHOM816L125GRB

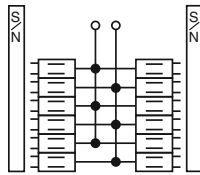

CHOM1224L125GC
CHOM1224L125GRB

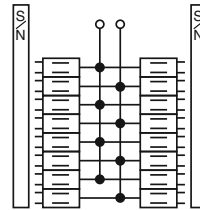

CHOM1632L125GC

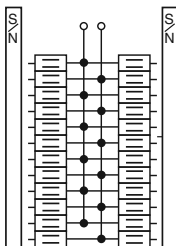

CHOM2448L125GC

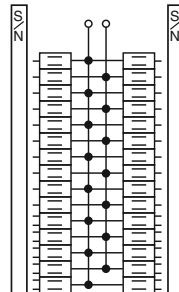

CHOM3060L225GC

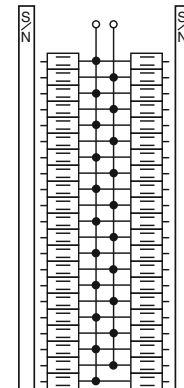

CHOM4284L225GC

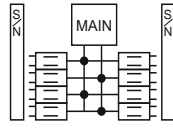

CHOM816M100RB

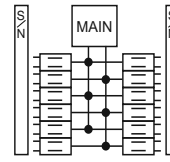

CHOM1224M100GC
CHOM1224M125GC
CHOM1224M100GR

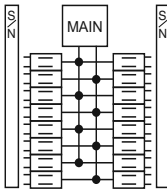

CHOM1632M100GC
CHOM1632M125GC

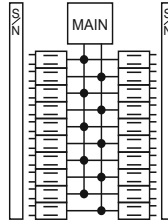

CHOM2040M150GC
CHOM2040M200GC
CHOM2040M200GRB

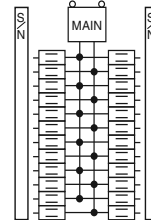

CHOM2448M100GC
CHOM2448M125GC

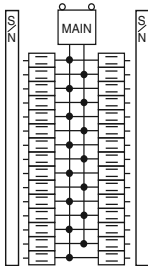

CHOM3060M100GC
CHOM3060M125GC
CHOM3060M150GC
CHOM3060M200GC
CHOM3060M2100GC

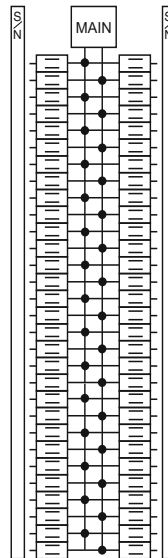

CHOM60120M200GC

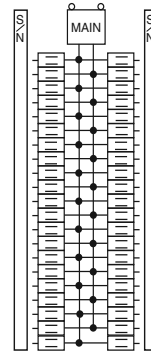

CHOM4284M200GC
CHOM4284M2100GC

1-Phase, 3-Wire Main Circuit Breakers

Canadian HomeLine™ Circuit Breakers and Loadcentres

Indoor Dimensions and Knockouts

DE1 LOAD CENTRES

INDOOR DIMENSIONS AND KNOCKOUTS

Indoor Dimensions						
Box No.	W		H		D	
	in.	mm	in.	mm	in.	mm
2	4.81	122	9.30	236	3.19	81
4	8.88	226	12.57	319	3.80	97
6	14.25	362	17.92	455	3.75	95
7	14.25	362	20.92	531	3.75	95
8	14.25	362	26.04	661	3.75	95
9	14.25	362	29.86	758	3.75	95
10	14.25	362	33.78	858	3.75	95
12	14.25	362	39.37	1000	3.75	95
21	8.88	226	14.80	376	3.80	97
24*	14.25	362	48.50	1232	3.75	95

Knockouts									
Symbol	A	B	C	D	E	F	G	H	I
Conduit Size	0.50 in. 13 mm	0.75 in. 19 mm	1.00 in. 25 mm	1.25 in. 32 mm	1.50 in. 38 mm	2.00 in. 51 mm	2.50 in. 64 mm	3.00 in. 76 mm	3.50 in. 89 mm

* Note: Box 24 knockout drawing to follow.

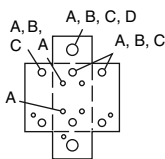

Box 2

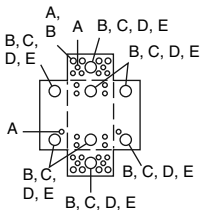

Box 4

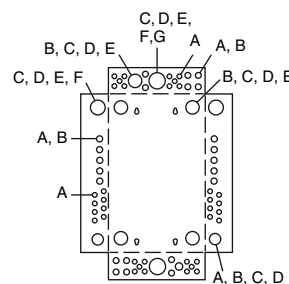

Box 7

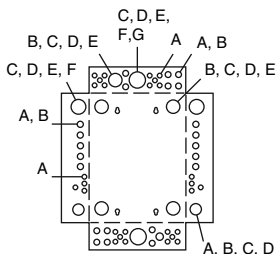

Box 6

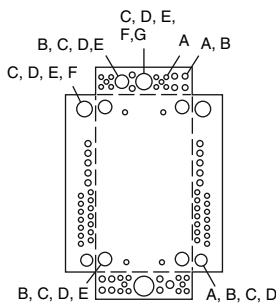

Box 8

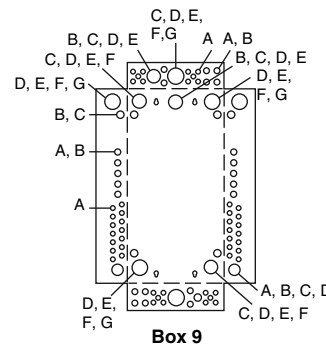

Box 9

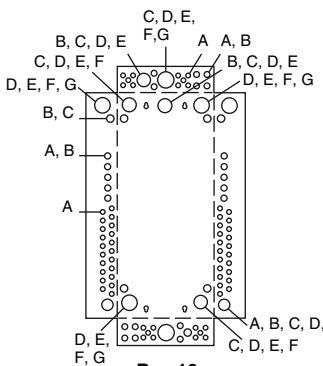

Box 10

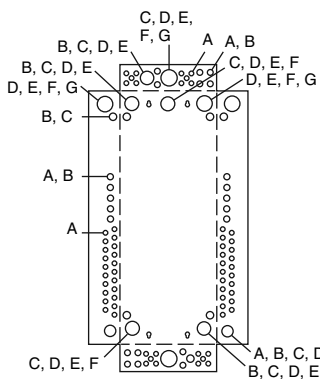

Box 12

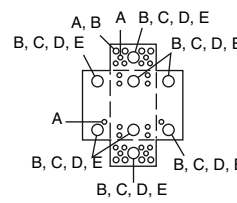

Box 21

Canadian HomeLine™ Circuit Breakers and Loadcentres

Outdoor Dimensions and Knockouts

OUTDOOR DIMENSIONS AND KNOCKOUTS

Outdoor Dimensions						
Box No.	W		H		D	
	in.	mm	in.	mm	in.	mm
1R ¹	4.88	124	9.38	238	4.00	102
2R	8.88	226	12.65	321	4.27	108
3R	14.75	375	18.92	481	4.52	115
6R	14.75	375	29.86	758	4.52	115
15R	8.88	226	14.80	376	4.27	108

¹ CHOME250SPA top endwall has no hub opening.

Knockouts								
Symbol	A	B	C	D	E	F	G	H
Conduit Size	0.50 in. 13 mm	0.75 in. 19 mm	1.00 in. 25 mm	1.25 in. 32 mm	1.50 in. 38 mm	2.00 in. 51 mm	2.50 in. 64 mm	3.00 in. 76 mm

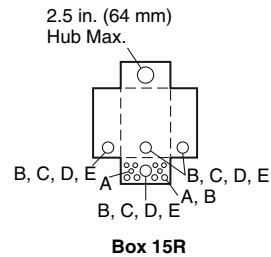
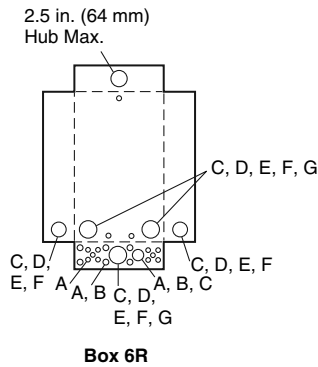
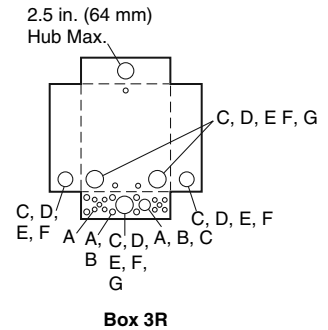
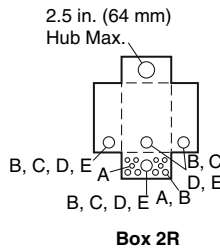
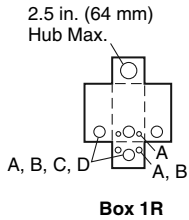

E.&O.E.

