

sollos[®]

LANDSCAPE LIGHTING
A Halco Lighting Technologies Company



THE ART OF OUTDOOR ILLUMINATION



Table of Contents



Page 5



Page 16



Page 30



Page 33



Page 34



Page 36



Page 38



Page 43



Page 44

2	The Art of Outdoor Illumination
2	Why Choose Sollos?
3	Sollos & Halco ProLED Advantage
5	Up & Accent Lights
15	Lamp Guide
16	Path Lights
26	Lamp Guide
30	In-Ground & Well Lights
33	Ledge Lights
34	Step Lights
36	Deck Lights
38	Hanging Lights
40	Lamp Guide
43	DecoStrand Lights
44	Commercial Transformers
45	Integrated Transformers
46	Accessories
47	ProLED Volt-Ampere Guide
48	Warranty

The Art of Outdoor Illumination

Sollos Landscape Lighting offers a complete line of fixtures and finishes that enhance gardens, landscapes and outdoor settings. Surroundings are enriched by the subtle curves and organic feel of natural metal and architectural aluminum finishes. Dynamic fixture functionality provides safety, security and quality illumination.

Superior thermal management allows Sollos fixtures to operate both halogen and LED lamp technologies. Sollos fixtures powered by energy efficient Halco ProLED lamps provide consistent, reliable light output.

Sollos Landscape Lighting combines aesthetic styling and ProLED power for today's landscapes.



Why Choose Sollos?

Sollos Landscape Lighting was born out of an unmet need in the marketplace for a line of architectural fixtures designed to operate retrofit LED lamps. As a Halco Lighting Technologies Company, Sollos leveraged Halco's lamp expertise to be the first to market with a full line of landscape lighting fixtures designed to operate with both traditional and advanced technology retrofit lamps. The Sollos design methodology centers around form, function and efficiency.

Sollos & Halco ProLED Advantage

When powered by ProLED lamps, Sollos fixtures provide sustainable, high performance and quality LED illumination.

Powered by ProLED

ProLED lamps are constructed with LED chips, integrated drivers and transformers. ProLED lamps utilize a special heat sink to safely drive the components and achieve a long lifespan. The input voltage range of ProLED lamps eliminate voltage drop, which is a common hurdle with traditional lamp technologies. ProLED lamps perform to specification at every input voltage within their voltage range.

For applications that normally require that the lamp is protected from the elements, Halco offers ingress protection (IP) rated ProLED lamps.

Rigorous adherence to design and manufacturing specifications ensures consistent lamp-to-lamp color, light output and beam spreads. ProLED lamps are available in 2700K, 3000K and a variety of colors including amber, red, green, blue and color-changing red-green-blue (RGB). LM-79 and IES files are available for all ProLED lamps upon request.



Strongest Lamp Warranty

20
Year
Warranty

When installed in a Sollos fixture in recommended conditions and packaging warnings are followed, ProLED MR16 and IP65-rated JC lamps are backed by a 20-year limited warranty, the strongest lamp warranty in the industry. When installed in other fixtures, these lamps are backed by a 5-year Limited Warranty. ProLED 912 lamps and non-IP65-rated JC lamps are backed by a 2-year Limited Warranty.

Think Lumens!

Efficient lighting technologies such as LED and compact fluorescent lamps produce comparable light output while consuming considerably less energy than traditional light sources. When evaluating replacement lamps, refer to lamps' light output, which is measured in lumens, rather than wattage. Lamps with relatively equivalent lumens and CBCP will provide similar illumination. So think lumens for light output and use lamp wattage to determine energy savings.



Up & Accent Lights



Contemporary, Straight & Modern Bullet

Mix and Match Bullet Light Ordering

Sollos Bullet Lights are supplied with an 8" ground stake. To order with lamp, please provide the lamp part number (indicated below) with the fixture order code from the following pages.

1 Select the Fixture:



Contemporary
Bullet



Straight
Bullet



Modern
Bullet

2 Select the Finish:

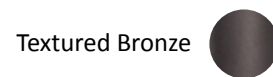
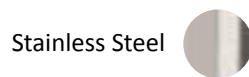
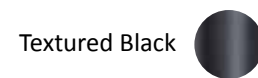
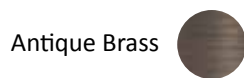

3 Select the Light Output Equivalent:



MR16FL10/827/LED



MR16BAB/827/LED



JC2S/827/LED2



JC35/4WW/LED

For the complete ProLED offering of lamps see page 15.

Up & Accent Lights

Contemporary Bullet

Contemporary design with minimal footprint to deliver superior illumination for accenting landscape features. Cast Brass or Aluminum housing for additional architectural appeal with Antique Brass, Brass, Textured Black, and Textured Bronze finishes for diverse settings.

BCB065

Housing	Cast Brass or Architectural Aluminum
Lens	Clear Tempered Glass
Stem/Knuckle	Cast Brass or Architectural Aluminum
Wiring	3 ft. 18-2 Lead Wire
Lamp	MR16 (50W Max)
Mounting Accessory	8" Ground Stake Included

Order Codes

Antique Brass	BCB065-AB
Brass	BCB065-BR
Textured Black	BCB065-TB
Textured Bronze	BCB065-TZ



BCB065-AB

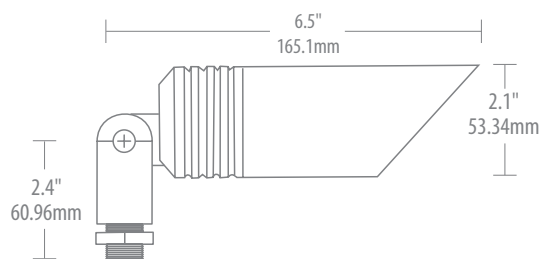
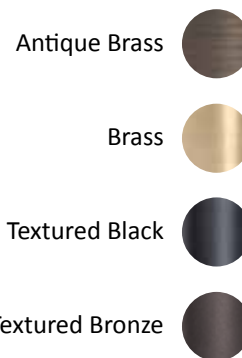

Recommended Lamps



Part Number	81055	81059	81064	81069
Product Code	MR16NFL10/827/LED	MR16BBF/827/LED	MR16FRA/827/LED	MR16EXZ/827/LED
Watts	2.5	4	4.5	8
Color Temp	2700K	2700K	2700K	2700K
Replacement Watt	10	20	35	50

For the complete ProLED offering of lamps see page 15.

Up & Accent Lights

Modern Bullet

Modern design with minimal footprint to deliver superior illumination for accenting landscape features. Aluminum housing for additional architectural appeal with Textured Black and Textured Bronze finishes for diverse settings.



BMB062-TB

Textured Black



Textured Bronze



BMB062

Housing	Architectural Aluminum
Lens	Clear Tempered Glass
Stem/Knuckle	Architectural Aluminum
Wiring	3 ft. 18-2 Lead Wire
Lamp	MR16 (50W Max)
Mounting Accessory	8" Ground Stake Included

Order Codes

Textured Black	BMB062-TB
Textured Bronze	BMB062-TZ

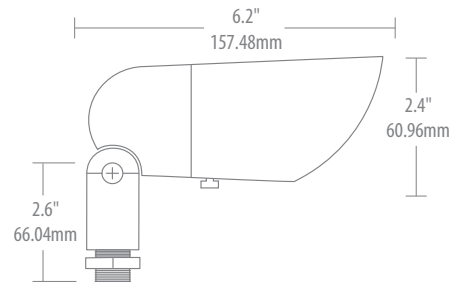

Recommended Lamps



Part Number	81079	81081	81083	81085
Product Code	MR16NFL10/830/LED	MR16BBF/830/LED	MR16FRA/830/LED	MR16EXZ/830/LED
Watts	2.5	4	4.5	8
Color Temp	3000k	3000k	3000k	3000k
Replacement Watt	10	20	35	50

For the complete ProLED offering of lamps see page 15.

Up & Accent Lights

Straight Bullet

Slender design with minimal footprint to deliver superior illumination for accenting landscape features. Cast Brass, Natural Copper, or Stainless Steel housing for additional architectural appeal with Antique Brass, Brass, Copper, and Stainless Steel finishes for diverse settings.

BSB067

Housing	Cast Brass, Natural Copper or Stainless Steel
Lens	Clear Tempered Glass
Stem/Knuckle	Cast Brass
Wiring	3 ft. 18-2 Lead Wire
Lamp	MR16 (50W Max)
Mounting Accessory	8" Ground Stake Included

Order Codes

Antique Brass	BSB067-AB
Brass	BSB067-BR
Copper	BSB067-CU
Stainless Steel	BSB067-SS



BSB067-BR

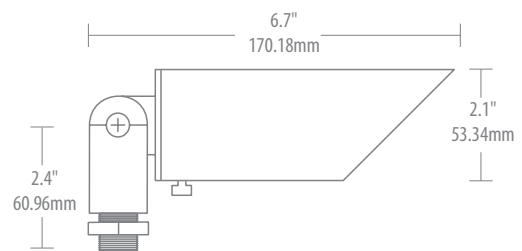

Recommended Lamps



Part Number	81056	81060	81065	81070
Product Code	MR16FL10/827/LED	MR16BAB/827/LED	MR16FMW/827/LED	MR16EXN/827/LED
Watts	2.5	4	4.5	8
Color Temp	2700k	2700k	2700k	2700k
Replacement Watt	10	20	35	50

For the complete ProLED offering of lamps see page 15.

Up & Accent Lights

Straight Bullet

Modern design with minimal footprint to deliver superior illumination for accenting landscape features. Aluminum housing for additional architectural appeal with Textured Black and Textured Bronze finishes for diverse settings.

BSB060

Housing	Architectural Aluminum
Lens	Clear Tempered Glass
Stem/Knuckle	Architectural Aluminum
Wiring	3 ft. 18-2 Lead Wire
Lamp	MR16 (50W Max)
Mounting Accessory	8" Ground Stake Included

Order Codes

Textured Black	BSB060-TB
Textured Bronze	BSB060-TZ

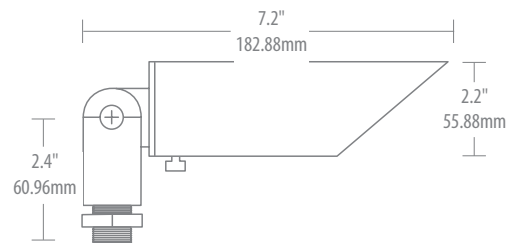

Recommended Lamps



Part Number	81077	81062	81067	81072
Product Code	MR16FL10/830/LED	MR16BAB/830/LED	MR16FMW/830/LED	MR16EXN/830/LED
Watts	2.5	4	4.5	8
Color Temp	3000k	3000k	3000k	3000k
Replacement Watt	10	20	35	50

For the complete ProLED offering of lamps see page 15.

Up & Accent Lights

Straight Bullet

Clean design with minimal footprint to deliver superior illumination for accenting landscape features. Aluminum housing for additional architectural appeal with Textured Black and Textured Bronze finishes for diverse settings.



BSB062-TZ

BSB062

Housing	Architectural Aluminum, Cast Brass, Natural Copper or Stainless Steel
Lens	Clear Tempered Glass
Stem/Knuckle	Architectural Aluminum or Cast Brass
Wiring	3 ft. 18-2 Lead Wire
Lamp	MR16 (35W Max)
Mounting Accessory	8" Ground Stake Included

Order Codes

Antique Brass	BSB062-AB
Brass	BSB062-BR
Copper	BSB062-CU
Stainless Steel	BSB062-SS
Textured Black	BSB062-TB
Textured Bronze	BSB062-TZ

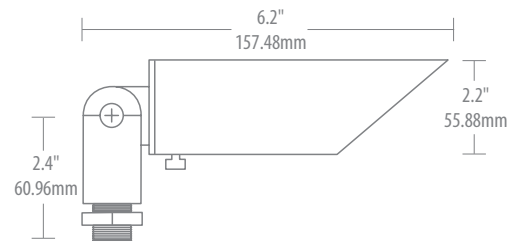

Recommended Lamps



Part Number	81057	81061	81066	81071
Product Code	MR16WFL10/827/LED	MR16WFL20/827/LED	MR16WFL35/827/LED	MR16FNV/827/LED
Watts	2.5	4	4.5	8
Color Temp	2700k	2700k	2700k	2700k
Replacement Watt	10	20	35	50

For the complete ProLED offering of lamps see page 15.

Up & Accent Lights

Straight Bullet

Traditional design with minimal footprint to deliver superior illumination for accenting landscape features. Aluminum, Cast brass, Natural Copper, or Stainless Steel housing for additional architectural appeal with Antique Brass, Brass, Copper, Stainless Steel, Textured Black, and Textured Bronze finishes for diverse settings.



BSB044-AB

BSB044

Housing	Architectural Aluminum, Cast Brass, Natural Copper, or Stainless Steel
Lens	Clear Tempered Glass
Stem/Knuckle	Architectural Aluminum or Cast Brass
Wiring	3 ft. 18-2 Lead Wire
Lamp	MR16 (35W Max)
Mounting Accessory	8" Ground Stake Included

Order Codes

Antique Brass	BSB044-AB
Brass	BSB044-BR
Copper	BSB044-CU
Stainless Steel	BSB044-SS
Textured Black	BSB044-TB
Textured Bronze	BSB044-TZ

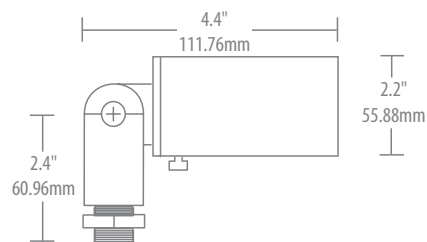

Recommended Lamps



Part Number	81080	81082	81084	81086
Product Code	MR16WFL10/830/LED	MR16WFL20/830/LED	MR16WFL35/830/LED	MR16FNV/830/LED
Watts	2.5	4	4.5	8
Color Temp	3000k	3000k	3000k	3000k
Replacement Watt	10	20	35	50

For the complete ProLED offering of lamps see page 15.

Up & Accent Lights

Straight Bullet

Sleek design with minimal footprint to deliver superior illumination for accenting landscape features. Cast Brass or Natural Copper housing for additional architectural appeal with Antique Brass, Brass, and Copper finishes for diverse settings.



BSB054-CU



BSB054

Housing	Cast Brass or Natural Copper
Lens	Clear Tempered Glass
Stem/Knuckle	Cast Brass
Wiring	3 ft. 18-2 Lead Wire
Lamp	MR11 (35W Max)
Mounting Accessory	8" Ground Stake Included

Order Codes

Antique Brass	BSB054-AB
Brass	BSB054-BR
Copper	BSB054-CU

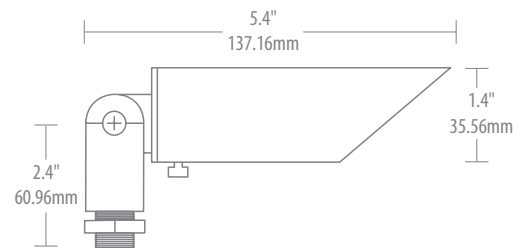

Recommended Lamps



Part Number	81093	81095	81096
Product Code	MR11FTD/827/LED	MR11FTD/850/LED	MR11FTC/827/LED
Watts	3	3	3
Color Temp	2700k	5000k	2700k
Replacement Watt	20	20	20

For the complete ProLED offering of lamps see page 15.

Up & Accent Lights

Flood Light

Contemporary design with a highly efficient reflector to deliver superior illumination for accenting landscape features. Aluminum or Cast brass housing for additional architectural appeal with Antique Brass, Textured Black, and Textured Bronze finishes for diverse settings.



FRF058-AB



FRF058

Housing	Cast Brass or Architectural Aluminum
Lens	Clear Tempered Glass
Stem/Knuckle	Cast Brass or Architectural Aluminum
Wiring	3 ft. 18-2 Lead Wire
Lamp	T4 Bi-Pin (50W Max)
Mounting Accessory	8" Ground Stake Included

Order Codes

Antique Brass	FRF058-AB
Textured Black	FRF058-TB
Textured Bronze	FRF058-TZ

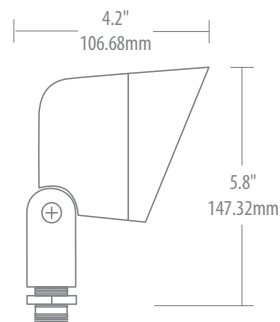

Recommended Lamps



Part Number	80830	80693	80690	80833
Product Code	JC35/4WW/LED	JC10/1WW/LED	JC20/2WW/LED	JC2/827/LED
Watts	4.5	1.5	2.4	2.4
Color Temp	3000K	3000K	3000K	2700K
Replacement Watt	35	10	20	20

For the complete ProLED offering of lamps see page 15.

Lamp Guide

Style	Size	Item #	Product Code	Finish	LED Lamp Product Code
 Contemporary Bullet	6.5"	995502	BCB065-AB	Antique Brass	 MR16NFL10/827/LED - 81055 MR16NFL10/830/LED - 81079 MR16FL10/827/LED - 81056 MR16FL10/830/LED - 81077 MR16FL10/850/LED - 81058 MR16WFL10/827/LED - 81057 MR16WFL10/830/LED - 81080 MR16NFL4/827/LED - 81103 MR16FL4/827/LED - 81098 MR16WFL4/827/LED - 81099 MR16BBF/827/LED - 81059 MR16BBF/830/LED - 81081 MR16BAB/827/LED - 81060 MR16BAB/830/LED - 81062 MR16BAB/850/LED - 81063 MR16WFL20/827/LED - 81061 MR16WFL20/830/LED - 81082 MR16FRA/827/LED - 81064 MR16FRA/830/LED - 81083 MR16FMW/827/LED - 81065 MR16FMW/830/LED - 81067 MR16FMW/850/LED - 81068 MR16WFL35/827/LED - 81066 MR16WFL35/830/LED - 81084 MR16EXZ/827/LED - 81069 MR16EXZ/830/LED - 81085 MR16EXN/827/LED - 81070 MR16EXN/830/LED - 81072 MR16EXN/850/LED - 81073 MR16FNV/827/LED - 81071 MR16FNV/830/LED - 81086 MR16/5RGB/FL/LED - 80728
		995500	BCB065-BR	Brass	
		995310	BCB065-TB	Textured Black	
		995314	BCB065-TZ	Textured Bronze	
 Modern Bullet	6.2"	995100	BMB062-TB	Textured Black	
		995104	BMB062-TZ	Textured Bronze	
 Straight Bullet	5.4"	995532	BSB067-AB	Antique Brass	
		885530	BSB067-BR	Brass	
		995534	BSB067-CU	Copper	
		995536	BSB067-SS	Stainless Steel	
		995300	BSB060-TB	Textured Black	
		995304	BSB060-TZ	Textured Bronze	
		995310	BSB062-TB	Textured Black	
		995314	BSB062-TZ	Textured Bronze	
		995522	BSB044-AB	Antique Brass	
		995520	BSB044-BR	Brass	
		995524	BSB044-CU	Copper	
		995526	BSB044-SS	Stainless Steel	
		995320	BSB044-TB	Textured Black	
		995324	BSB044-TZ	Textured Bronze	
 Straight Bullet	6.5"	995362	BSB054-AB	Antique Brass	 MR11FTD/827/LED - 81093 MR11FTD/850/LED - 81095 MR11FTC/827/LED - 81096
		995360	BSB054-BR	Brass	
		995364	BSB054-CU	Copper	
 Flood Light		995406	FRF058-AB	Antique Brass	 JC10/1WW/LED - 80693 JC2/827/LED - 80833 JC20/2WW/LED - 80690 JC20/2NW/LED - 80815 JC35/4WW/LED - 80830
		923006	FRF058-TB	Textured Black	
		923008	FRF058-TZ	Textured Bronze	

Path Lights

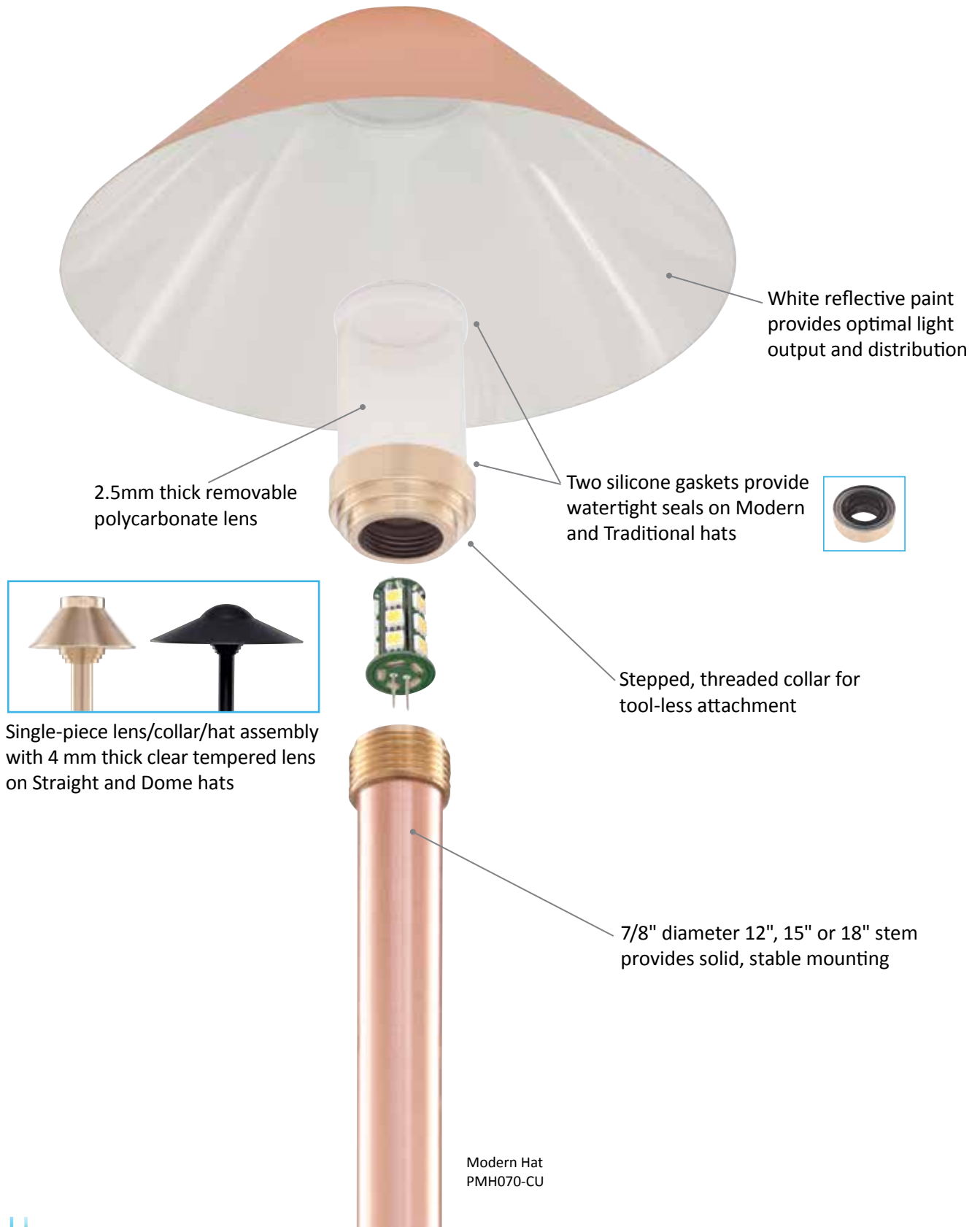

Modern, Traditional, Straight & Dome Hats

Mix and Match Path Light Ordering

Sollos Path Light kits include a hat, stem, 8" ground stake, and lamp. All Sollos Path Lights are supplied with a Halco JC20 halogen lamp unless another lamp model is specified.

1 Select the Hat:



2 Select the Stem Height:

- 12"
- 15"
- 18"

3 Select the Finish:



3 Select the Light Output Equivalent:



Example: To order an Antique Brass 5.5" Traditional Hat with 15" Stem and Halco ProLED JC20/2WW/LED Lamp, the order code would be **PTH055-AB-15-JC20/2WW/LED**

Path Lights

Traditional Hat

Traditional design that delivers safe and uniform illumination for your outdoor pathways. Brass or Stainless Steel housings for additional architectural appeal.



Brass



Stainless Steel



PTH075-AB-15



Recommended Lamps

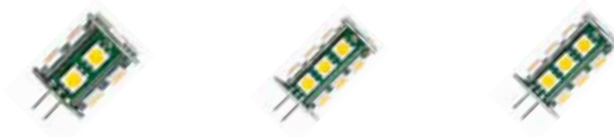

Part Number	80693	80690	80833
Product Code	JC10/1WW/LED	JC20/2WW/LED	JC2/827/LED
Watts	1.5	2.4	2.4
Color Temp	3000K	3000K	2700K
Replacement Watt	10	20	20

For the complete ProLED offering of lamps see pages 26-28.

Dimensions

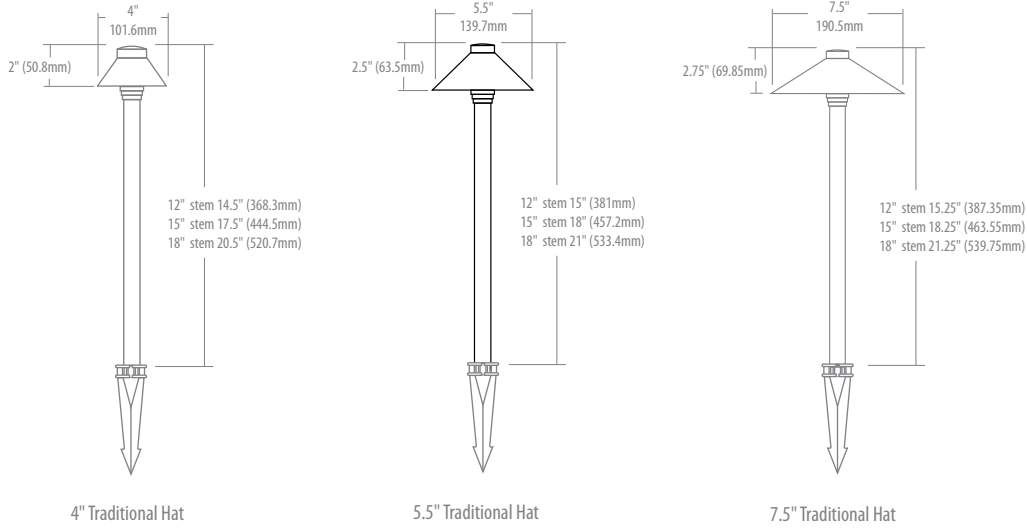

PTH

Housing	Brass or Stainless Steel
Lens	Clear Polycarbonate with Dual Silicone Gaskets
Collar	Brass
Stem Options	12", 15" and 18"
Wiring	3 ft. 18-2 Lead Wire
Lamp	T3 Bi-Pin (20W Max)
Mounting Accessory	8" Ground Stake Included

Order Codes	4" Diameter	5.5" Diameter	7.5" Diameter
12" Stem			
Antique Brass	PTH040-AB-12	PTH055-AB-12	PTH075-AB-12
Brass	PTH040-BR-12	PTH055-BR-12	PTH075-BR-12
Stainless Steel	PTH040-SS-12	PTH055-SS-12	
15" Stem			
Antique Brass	PTH040-AB-15	PTH055-AB-15	PTH075-AB-15
Brass	PTH040-BR-15	PTH055-BR-15	PTH075-BR-15
Stainless Steel		PTH055-SS-15	PTH075-SS-15
18" Stem			
Antique Brass	PTH040-AB-18	PTH055-AB-18	PTH075-AB-18
Brass	PTH040-BR-18	PTH055-BR-18	PTH075-BR-18
Stainless Steel		PTH055-SS-18	PTH075-SS-18

Example: To order a Brass 5.5" Traditional Hat with 12" Stem and Halco ProLED JC20/2WW/LED Lamp, the order code would be PTH055-BR-12-JC20/2WW/LED

Path Lights

Modern Hat

Modern design that delivers safe and uniform illumination for your outdoor pathways. Brass or Natural Copper housings for additional architectural appeal.

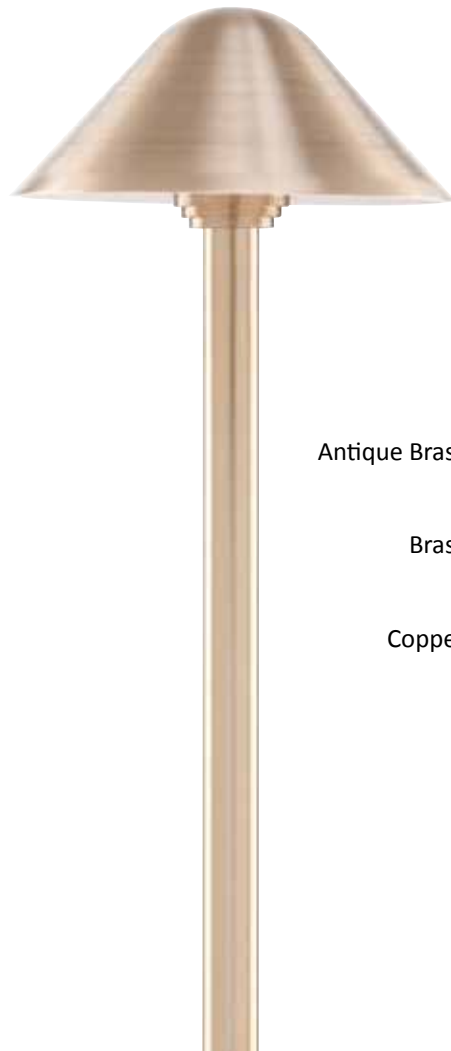

- Antique Brass 
- Brass 
- Copper 

PMH070-BR-18

Recommended Lamps



Part Number	80693	81109	81091
Product Code	JC10/1WW/LED	JC2/827/LED2	JC2S/827/LED2
Watts	1.5	2.3	1.4
Color Temp	3000K	2700K	2700K
Replacement Watt	10	20	20

For the complete ProLED offering of lamps see pages 26-28.

Dimensions

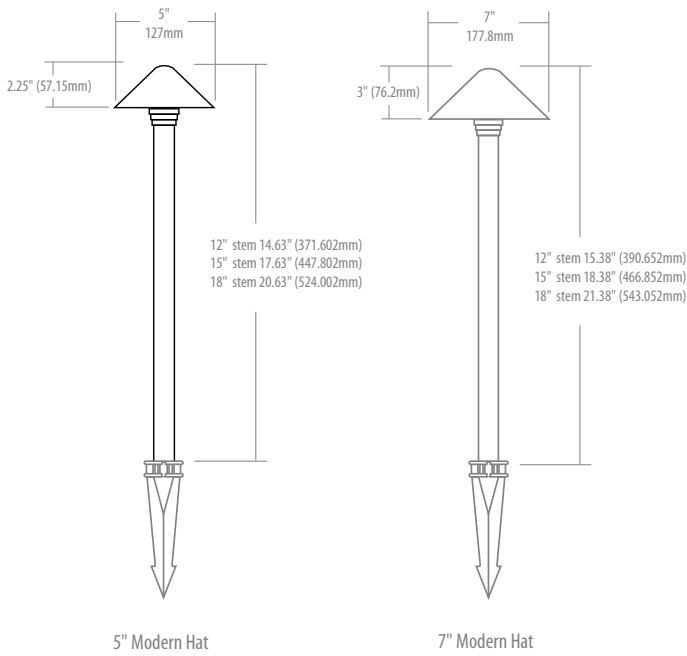

PMH

Housing	Brass or Natural Copper
Lens	Clear Polycarbonate with Dual Silicone Gaskets
Collar	Brass
Stem Options	12", 15" and 18"
Wiring	3 ft. 18-2 Lead Wire
Lamp	T3 Bi-Pin (20W Max)
Mounting Accessory	8" Ground Stake Included

Order Codes	5" Diameter	7" Diameter
12" Stem		
Antique Brass	PMH050-AB-12	PMH070-AB-12
Brass	PMH050-BR-12	PMH070-BR-12
Copper	PMH050-CU-12	PMH070-CU-12
15" Stem		
Antique Brass	PMH050-AB-15	PMH070-AB-15
Brass	PMH050-BR-15	PMH070-BR-15
Copper	PMH050-CU-15	PMH070-CU-15
18" Stem		
Antique Brass	PMH050-AB-18	PMH070-AB-18
Brass	PMH050-BR-18	PMH070-BR-18
Copper	PMH050-CU-18	PMH070-CU-18

Example: To order a Copper 5" Modern Hat with 18" Stem and Halco ProLED JC20/2WW/LED Lamp, the order code would be **PMH050-CU-18-JC20/2WW/LED**

Path Lights

Straight Hat

Traditional design that delivers safe and uniform illumination for your outdoor pathways. Textured Bronze housing for additional architectural appeal.



Textured Bronze



PSH040-TZ-18

Recommended Lamps



Part Number	81091	81092	81109
Product Code	JC2S/827/LED2	JC2S/830/LED2	JC2/827/LED2
Watts	1.4	1.4	2.3
Color Temp	2700K	3000K	2700K
Replacement Watt	20	20	20

For the complete ProLED offering of lamps see pages 26-28.

Dimensions

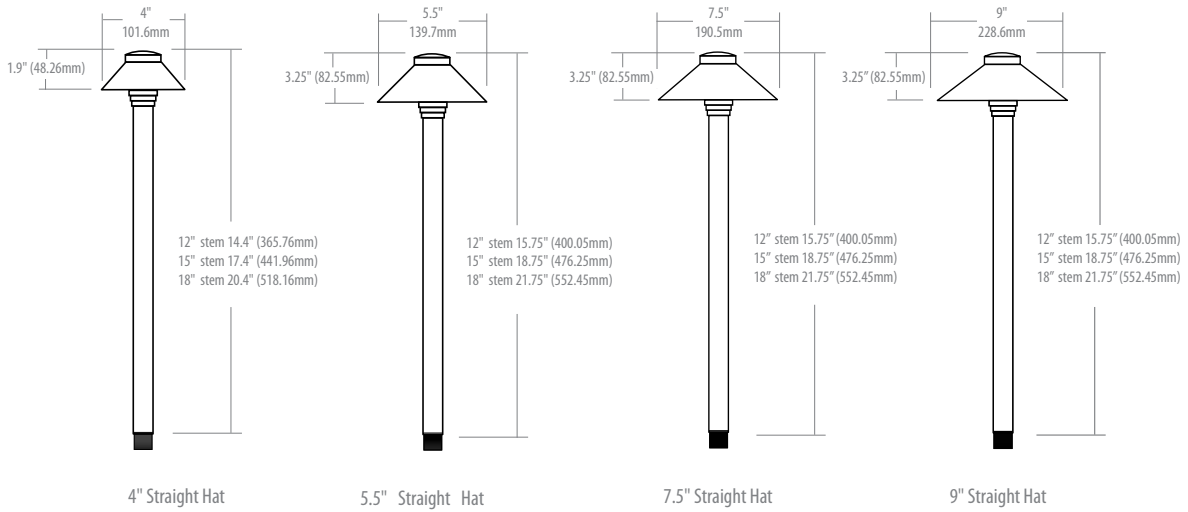

PSH

Housing	Architectural Aluminum
Lens	Clear Tempered Glass
Collar	Architectural Aluminum
Stem Options	12", 15" and 18"
Wiring	3 ft. 18-2 Lead Wire
Lamp	T3 Bi-Pin (20W Max)
Mounting Accessory	8" Ground Stake Included

Order Codes	4" Diameter	5.5" Diameter	7.5" Diameter	9" Diameter
12" Stem				
Textured Bronze	PSH040-TZ-12	PSH055-TZ-12	PSH075-TZ-12	PSH090-TZ-12
15" Stem				
Textured Bronze	PSH040-TZ-15	PSH055-TZ-15	PSH075-TZ-15	PSH090-TZ-15
18" Stem				
Textured Bronze	PSH040-TZ-18	PSH055-TZ-18	PSH075-TZ-18	PSH090-TZ-18

Example: To order a Textured Black 9" Straight Hat with 15" Stem and Halco ProLED JC20/2WW/LED Lamp, the order code would be **PSH090-TB-15-JC20/2WW/LED**

Path Lights

Dome Hat

Architectural design that delivers safe and uniform illumination for your outdoor pathways. Textured Black or Bronze housings for additional architectural appeal.



Textured Black



Textured Bronze



PDO

Housing	Architectural Aluminum
Lens	Clear Tempered Glass
Collar	Architectural Aluminum
Stem Options	12", 15" and 18"
Wiring	3 ft. 18-2 Lead Wire
Lamp	T3 Bi-Pin (20W Max)
Mounting Accessory	8" Ground Stake Included

Order Codes

12" Stem	
Textured Black	PDO083-TB-12
Textured Bronze	PDO083-TZ-12
15" Stem	
Textured Black	PDO083-TB-15
Textured Bronze	PDO083-TZ-15
18" Stem	
Textured Black	PDO083-TB-18
Textured Bronze	PDO083-TZ-18

Example: To order a Textured Bronze 8.3" Dome Hat with 18" Stem and Halco ProLED JC20/2WW/LED Lamp, the order code would be **PDO083-TZ-18-JC20/2WW/LED**

PDO083-TZ-15

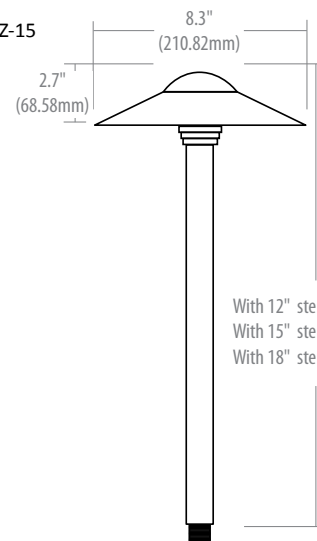

Recommended Lamps

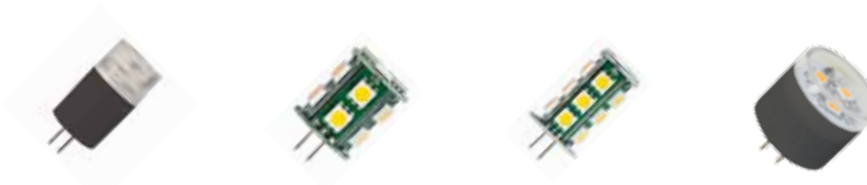

Part Number	81108	80693	80690	81091
Product Code	JC20/2WW/LED2	JC10/1WW/LED	JC20/2WW/LED	JC2S/827/LED2
Watts	2.3	1.5	2.4	1.4
Color Temp	3000K	3000K	3000K	2700K
Replacement Watt	20	10	20	20

For the complete ProLED offering of lamps see pages 26-28.

Path Lights

Mushroom Hat

Architectural design that delivers safe and uniform illumination for your outdoor pathways. Textured Black or Bronze housings for additional architectural appeal.



PMU050-TB-15

Textured Black



Textured Bronze



PMU

Housing	Architectural Aluminum
Lens	Clear Tempered Glass with Dual Silicone Gaskets
Stem Options	15" Included
Wiring	3 ft. 18-2 Lead Wire
Lamp	T3 Bi-Pin (20W Max)
Mounting Accessory	8" Ground Stake Included

Order Codes

15" Stem	
Textured Black	PMU050-TB-15
Textured Bronze	PMU050-TZ-15

Example: To order a Textured Black 5" Mushroom with Halco ProLED JC20/2WW/LED Lamp, the order code would be **PMU050-TB-15-JC20/2WW/LED**

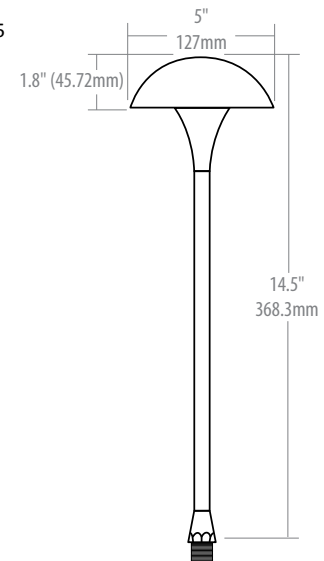



Recommended Lamps







Part Number	80693	80690	81091	81109
Product Code	JC10/1WW/LED	JC20/2WW/LED	JC2S/827/LED2	JC2/827/LED2
Watts	1.5	2.4	1.4	2.3
Color Temp	3000K	3000K	2700K	2700K
Replacement Watt	10	20	20	20

For the complete ProLED offering of lamps see pages 26-28.





Lamp Guide

Style	Size	Item #	Product Code	Finish	LED Lamp Product Code
 <p>Modern Hat</p>	5"	915200	PMH050-AB-12	Antique Brass	 <p>JC10/1WW/LED - 80693 JC2/827/LED - 80833 JC20/2WW/LED - 80690 JC20/2NW/LED - 80815 JC35/4WW/LED - 80830 JC2S/827/LED2 - 81091 JC2S/830/LED2 - 81092 JC2/827/LED2 - 81109 JC20/2WW/LED2 - 81108</p>
		915201	PMH050-BR-12	Brass	
		915202	PMH050-CU-12	Copper	
	5"	915203	PMH050-AB-15	Antique Brass	
		915204	PMH050-BR-15	Brass	
		915205	PMH050-CU-15	Copper	
	5"	915206	PMH050-AB-18	Antique Brass	
		915207	PMH050-BR-18	Brass	
		915208	PMH050-CU-18	Copper	
	5"	915254	PMH070-AB-12	Antique Brass	
		915255	PMH070-BR-12	Brass	
		915256	PMH070-CU-12	Copper	
	5"	915257	PMH070-AB-15	Antique Brass	
		915258	PMH070-BR-12	Brass	
		915259	PMH070-CU-15	Copper	
	5"	915260	PMH070-AB-18	Antique Brass	
		915261	PMH070-BR-18	Brass	
		915262	PMH070-CU-18	Copper	
 <p>Traditional Hat</p>	4"	915400	PTH040-AB-12	Antique Brass	
		915401	PTH040-BR-12	Brass	
		915402	PTH040-CU-12	Copper	
		915562	PTH040-SS-12	Stainless Steel	
	4"	915403	PTH040-AB-15	Antique Brass	
		915404	PTH040-BR-15	Brass	
		915405	PTH040-CU-15	Copper	
	4"	915406	PTH040-AB-18	Antique Brass	
		915407	PTH040-BR-18	Brass	
		915408	PTH040-CU-18	Copper	
	5.5"	915454	PTH055-AB-12	Antique Brass	
		915455	PTH055-BR-12	Brass	
		915456	PTH055-CU-12	Copper	
		915563	PTH055-SS-12	Stainless Steel	
	5.5"	915457	PTH055-AB-15	Antique Brass	
		915458	PTH055-BR-15	Brass	
		915459	PTH055-CU-15	Copper	
		915564	PTH055-SS-15	Stainless Steel	
	5.5"	915460	PTH055-AB-18	Antique Brass	
		915461	PTH055-BR-18	Brass	
915462		PTH055-CU-18	Copper		
915565		PTH055-SS-18	Stainless Steel		

Lamp Guide

Style	Size	Item #	Product Code	Finish	LED Lamp Product Code
 <p>Traditional Hat</p>	7.5"	915508	PTH075-AB-12	Antique Brass	 <p>JC10/1WW/LED - 80693 JC2/827/LED - 80833 JC20/2WW/LED - 80690 JC20/2NW/LED - 80815 JC35/4WW/LED - 80830 JC2S/827/LED2 - 81091 JC2S/830/LED2 - 81092 JC2/827/LED2 - 81109 JC20/2WW/LED2 - 81108</p>
		915509	PTH075-BR-12	Brass	
		915510	PTH075-CU-12	Copper	
	7.5"	915511	PTH075-AB-15	Antique Brass	
		915512	PTH075-BR-15	Brass	
		915513	PTH075-CU-15	Copper	
	7.5"	915514	PTH075-AB-18	Antique Brass	
		915515	PTH075-BR-18	Brass	
		915516	PTH075-CU-18	Copper	
 <p>Straight Hat</p>	4"	913021	PSH040-TB-12	Textured Black	 <p>JC10/1WW/LED - 80693 JC2/827/LED - 80833 JC20/2WW/LED - 80690 JC20/2NW/LED - 80815 JC35/4WW/LED - 80830 JC2S/827/LED2 - 81091 JC2S/830/LED2 - 81092 JC2/827/LED2 - 81109 JC20/2WW/LED2 - 81108</p>
		913023	PSH040-TZ-12	Textured Bronze	
	4"	913028	PSH040-TB-15	Textured Black	
		913030	PSH040-TZ-15	Textured Bronze	
	4"	913035	PSH040-TB-18	Textured Black	
		913037	PSH040-TZ-18	Textured Bronze	
	5.5"	910021	PSH055-TB-12	Textured Black	
		910023	PSH055-TZ-12	Textured Bronze	
	5.5"	910028	PSH055-TB-15	Textured Black	
		910030	PSH055-TZ-15	Textured Bronze	
	5.5"	910035	PSH055-TB-18	Textured Black	
		910037	PSH055-TZ-18	Textured Bronze	
	7.5"	911021	PSH075-TB-12	Textured Black	
		911023	PSH075-TZ-12	Textured Bronze	
	7.5"	911028	PSH075-TB-15	Textured Black	
		911030	PSH075-TZ-15	Textured Bronze	
	7.5"	911035	PSH075-TB-18	Textured Black	
		911037	PSH075-TZ-18	Textured Bronze	
	9"	914021	PSH090-TB-12	Textured Black	
		914023	PSH090-TZ-12	Textured Bronze	
	9"	914028	PSH090-TB-15	Textured Black	
914030		PSH090-TZ-15	Textured Bronze		
9"	914035	PSH090-TB-18	Textured Black		
	914037	PSH090-TZ-18	Textured Bronze		

Lamp Guide

Style	Size	Item #	Product Code	Finish	LED Lamp Product Code
 <p>Dome Hat</p>	8.3"	915021	PDO083-TB12	Textured Black	 <p>JC10/1WW/LED - 80693 JC2/827/LED - 80833 JC20/2WW/LED - 80690 JC20/2NW/LED - 80815 JC35/4WW/LED - 80830 JC2S/827/LED2 - 81091 JC2S/830/LED2 - 81092 JC2/827/LED2 - 81109 JC20/2WW/LED2 - 81108</p>
		915023	PDO083-TZ12	Textured Bronze	
	8.3"	915028	PDO083-TB15	Textured Black	
		915030	PDO083-TZ15	Textured Bronze	
	8.3"	915035	PDO083-TB18	Textured Black	
		915037	PDO083-TZ18	Textured Bronze	
 <p>Mushroom</p>	5"	910021	PSH055-TB-12	Textured Black	 <p>JC10/1WW/LED - 80693 JC2/827/LED - 80833 JC20/2WW/LED - 80690 JC20/2NW/LED - 80815 JC35/4WW/LED - 80830 JC2S/827/LED2 - 81091 JC2S/830/LED2 - 81092 JC2/827/LED2 - 81109 JC20/2WW/LED2 - 81108</p>
		910023	PSH055-TZ-12	Textured Bronze	



In-Ground Lights

Rock Guard

Durable construction to deliver high performance illumination for desired up light needs. Antique Brass, Brass, Composite Black, and Stainless Steel covers for additional architectural appeal.



IGG049-BR

IGG049

Housing	Single-Piece Compression Molded Polyester Composite
Lens	Shock and Heat-Resistant Clear Tempered Glass
Cover	Brass, Composite or Stainless Steel
Aiming	Adjustable Lamp Bracket Provides +/- 15° of Tilt
Wiring	3 ft. 18-2 Lead Wire
Lamp	MR16 (50W Max)

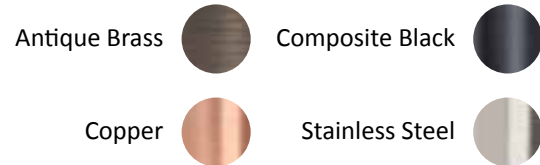

Order Codes

Antique Brass	IGG049-AB
Brass	IGG049-BR
Composite Black	IGG049-CB
Stainless Steel	IGG049-SS

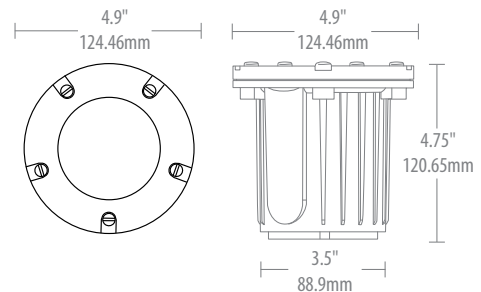

Recommended Lamps



Part Number	81056	81060	81065	81070
Product Code	MR16FL10/827/LED	MR16BAB/827/LED	MR16FMW/827/LED	MR16EXN/827/LED
Watts	2.5	4	4.5	8
Color Temp	2700k	2700k	2700k	2700k
Replacement Watt	10	20	35	50

For the complete ProLED offering of lamps see pages 40-41.

In-Ground Lights

Trim Ring

Durable construction to deliver high performance illumination for desired up light needs. Antique Brass, Brass, Composite Black, and Stainless Steel covers for additional architectural appeal.



IGT049-BR

IGT049

Housing	Single-Piece Compression Molded Polyester Composite
Lens	Shock and Heat-Resistant Clear Tempered Glass
Cover	Brass, Composite or Stainless Steel
Aiming	Adjustable Lamp Bracket Provides +/- 15° of Tilt
Wiring	3 ft. 18-2 Lead Wire
Lamp	MR16 (50W Max)

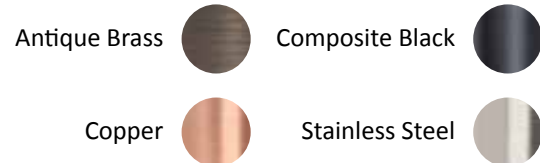

Order Codes

Antique Brass	IGT049-AB
Brass	IGT049-BR
Composite Black	IGT049-CB
Stainless Steel	IGT049-SS

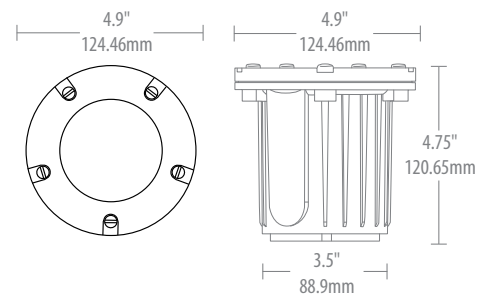

Recommended Lamps



Part Number	81058	81062	81067	81072
Product Code	MR16FL10/850/LED	MR16BAB/830/LED	MR16FMW/830/LED	MR16EXN/830/LED
Watts	2.5	4	4.5	8
Color Temp	5000k	3000k	3000k	3000k
Replacement Watt	10	20	35	50

For the complete ProLED offering of lamps see pages 40-41.

In-Ground Lights

Well Light

Durable construction to deliver high performance illumination for desired up light needs. Composite Black housing to blend with surroundings.



WPO055-CB

WPO055

Housing	Composite Black ABS
Lamp Holder	Adjustable Height and Angle
Aiming	360° Lamp Rotation
Wiring	3 ft. 18-2 Lead Wire with Slip-on Connectors
Lamp	PAR36 (50W Max)

Order Codes

Well Light	WPO055-CB
Replacement Bracket	WPO055-BRACKET

Composite Black

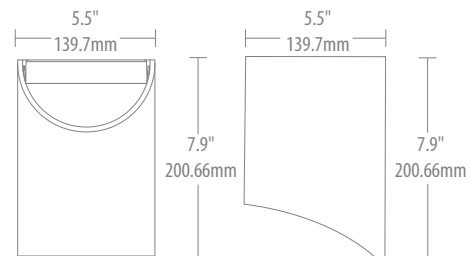

Recommended Lamps



Part Number	81074	81075	81076
Product Code	PAR36WFL4/827/IP67/LED	PAR36WFL6/827/IP67/LED	PAR36WFL12/827/IP67/LED
Watts	4	6	12
Color Temp	2700k	2700k	2700k
Replacement Watt	20	35	50

For the complete ProLED offering of lamps see pages 40-41.

Ledge Lights

Low profile design that delivers uniform illumination to accentuate key hardscape features. Textured Black and Textured Bronze housings for additional architectural appeal.

LLA055

Housing	Architectural Aluminum
Lens	Shock and Heat-Resistant Frosted Tempered Glass
Wiring	10 ft. (3 m) 18-2 lead-wire
Lamp	0.6 Watt, 2700K LED

Order Codes

Textured Black	LLA055/827/TB
Textured Bronze	LLA055/827/TZ
Light Module	LLA055/827



LLA055/827/TB



LLA055/827
Replaceable Light Module

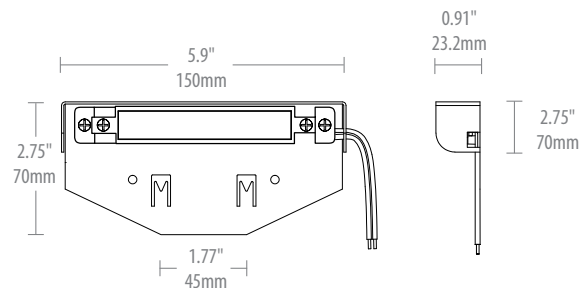
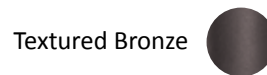
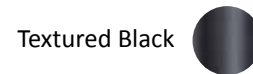

Step Lights

with Trim Faceplate

Low profile design that delivers uniform illumination to accentuate key hardscape features. Brass, Copper, Stainless Steel, Textured Black, and Textured Bronze faceplates for additional architectural appeal.



SBT048-TZ

SBT048

Housing	Die Cast Aluminum with Adjustable Mounting Brackets
Faceplate	Brass, Copper, Stainless Steel, or Architectural Grade Aluminum
Faceplate Mounting	Adjustable Nylon Mounts Correct Undesired Tilt
Lens	Shock and Heat-Resistant Frosted Tempered Glass
Aiming	Adjustable Socket for Proper Lamp Centering
Wiring	3 ft. 18-2 Lead Wire
Lamp	T3 Bi-Pin (20W Max)



Order Codes

Brass	SBT048-BR
Copper	SBT048-CU
Stainless Steel	SBT048-SS
Textured Black	SBT048-TB
Textured Bronze	SBT048-TZ

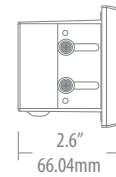
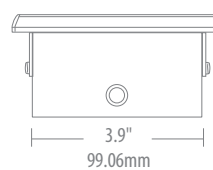
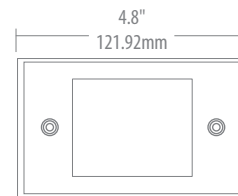

Recommended Lamps

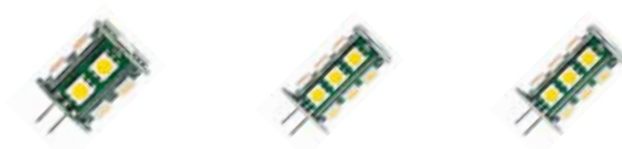

Part Number	80693	80833	80690
Product Code	JC10/1WW/LED	JC2/827/LED	JC20/2WW/LED
Watts	1.5	2.4	2.4
Color Temp	3000K	2700K	3000K
Replacement Watt	10	20	20

For the complete ProLED offering of lamps see pages 40-41.

Step Lights

with Louver Faceplate

Low profile design that delivers uniform illumination to accentuate key hardscape features. Brass, Textured Black, and Textured Bronze faceplates for additional architectural appeal.



SBL048-BR

SBL048

Housing	Die Cast Aluminum with Adjustable Mounting Brackets
Faceplate	Brass or Architectural Grade Aluminum
Faceplate Mounting	Adjustable Nylon Mounts Correct Undesired Tilt
Lens	Shock and Heat-Resistant Frosted Tempered Glass
Aiming	Adjustable Socket for Proper Lamp Centering
Wiring	3 ft. 18-2 Lead Wire
Lamp	T3 Bi-Pin (20W Max)

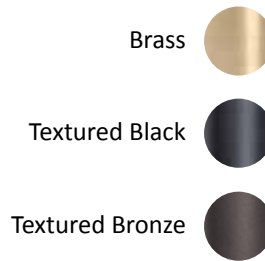

Order Codes	With Trim	With Louver
Brass	SBT048-BR	SBL048-BR
Textured Black	SBT048-TB	SBL048-TB
Textured Bronze	SBT048-TZ	SBL048-TZ

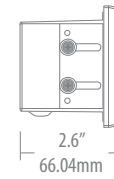
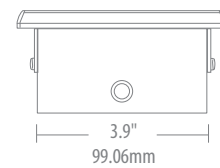
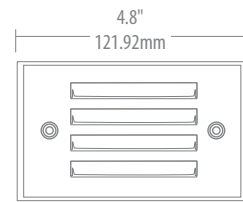

Recommended Lamps

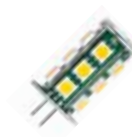
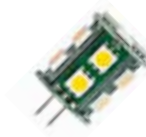

Part Number	81091	80693	80815
Product Code	JC2S/827/LED2	JC10/1WW/LED	JC20/2NW/LED
Watts	1.4	1.5	2.4
Color Temp	2700K	3000K	5000K
Replacement Watt	20	10	20

For the complete ProLED offering of lamps see pages 40-41.

Deck Lights

Post Lights

Traditional design that delivers uniform illumination to accentuate key hardscape features. Antique Brass, Textured Black, and Textured Bronze faceplates for additional architectural appeal.



DPL033-AB

DPL033

Housing	Die Cast Aluminum or Brass
Lens	Shock and Heat-Resistant Frosted Tempered Glass
Mounting	Surface Mounting Plate
Wiring	3 ft. 18-2 Lead Wire
Lamp	T3 Bi-Pin (10W Max Brass; 20W Max Aluminum)

Order Codes

Antique Brass	DPL033-AB
Textured Black	DPL033-TB
Textured Bronze	DPL033-TZ

Antique Brass



Textured Black



Textured Bronze

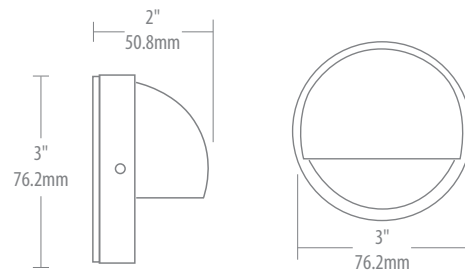

Recommended Lamps



Part Number	80693	80690	80833	81091
Product Code	JC10/1WW/LED	JC20/2WW/LED	JC2/827/LED	JC2S/827/LED2
Watts	1.5	2.4	2.4	1.4
Color Temp	3000K	3000K	2700K	2700K
Replacement Watt	10	20	20	20

For the complete ProLED offering of lamps see pages 40-41.

Deck Lights

Under-Step Lights

Low profile design that delivers uniform illumination to accentuate key hardscape features. Antique Brass, Copper, and Stainless Steel faceplates for additional architectural appeal.



DUS120-SS



DUS060-CU

DUS060/DUS120

Housing	Die Cast Aluminum
Cover	Antique Brass, Natural Copper, or Stainless Steel
Lens	Shock and Heat-Resistant Frosted Tempered Glass
Mounting	Optional Stainless Steel Mounting Plate for Hardscape Installations
Wiring	3 ft. 18-2 Lead Wire
Lamp	912 Wedge (20W Max) - DUS120 Operates Two Lamps

Order Codes	6" Length	12" Length
Antique Brass	DUS060-AB	
Copper	DUS060-CU	DUS120-CU
Stainless Steel	DUS060-SS	DUS120-SS
Mounting Plate	MP06	MP12

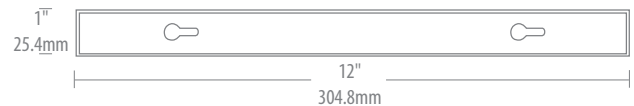

12" Deck Under-Step Light

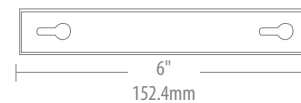

6" Deck Under-Step Light

Recommended Lamps



Part Number	80791	81102
Product Code	912/1WW/LED	912/1WW/LED2
Watts	1	1.2
Color Temp	3000K	3000K
Replacement Watt	10	10

For the complete ProLED offering of lamps see pages 40-41.

Hanging Lights

Pendant Lights

Traditional design that delivers uniform illumination to accentuate key hardscape features. Antique Brass, Brass, and Copper housings for additional architectural appeal.



HLS043-CU

HLS043

Housing	Cast Brass or Natural Copper
Lens	Clear Tempered Glass
Base	Cast Brass
Wiring	3 ft. 18-2 Lead Wire
Lamp	MR16 (35W Max)
Mounting Accessory	6 ft. Stainless Steel Hanger Included

Order Codes

Antique Brass	HLS043-AB
Brass	HLS043-BR
Copper	HLS043-CU

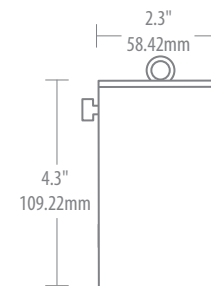
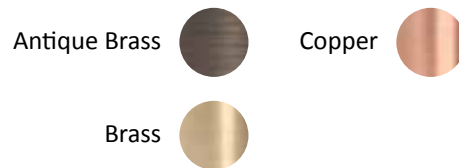

Recommended Lamps









Part Number	81057	81061	81066	81071
Product Code	MR16WFL10/827/LED	MR16WFL20/827/LED	MR16WFL35/827/LED	MR16FNV/827/LED
Watts	2.5	4	4.5	8
Color Temp	2700k	2700k	2700k	2700k
Replacement Watt	10	20	35	50

For the complete ProLED offering of lamps see pages 40-41.



Lamp Guide

Style	Size	Item #	Product Code	Finish	LED Lamp Product Code	
 <p>In-Ground w/Rock Guard</p>		996232	IGG049-AB	Antique Brass	 <p>MR16NFL10/827/LED - 81055 MR16NFL10/830/LED - 81079 MR16FL10/827/LED - 81056 MR16FL10/830/LED - 81077 MR16FL10/850/LED - 81058 MR16WFL10/827/LED - 81057 MR16WFL10/830/LED - 81080 MR16NFL4/827/LED - 81103 MR16FL4/827/LED - 81098 MR16WFL4/827/LED - 81099 MR16BBF/827/LED - 81059 MR16BBF/830/LED - 81081 MR16BAB/827/LED - 81060 MR16BAB/830/LED - 81062 MR16BAB/850/LED - 81063 MR16WFL20/827/LED - 81061 MR16WFL20/830/LED - 81082 MR16FRA/827/LED - 81064 MR16FRA/830/LED - 81083 MR16FMW/827/LED - 81065 MR16FMW/830/LED - 81067 MR16FMW/850/LED - 81068 MR16WFL35/827/LED - 81066 MR16WFL35/830/LED - 81084 MR16EXZ/827/LED - 81069 MR16EXZ/830/LED - 81085 MR16EXN/827/LED - 81070 MR16EXN/830/LED - 81072 MR16EXN/850/LED - 81073 MR16FNV/827/LED - 81071 MR16FNV/830/LED - 81086 MR16/5RGB/FL/LED - 80728</p>	
		996230	IGG049-BR	Brass		
		996200	IGG049-CB	Composite Black		
		996234	IGG049-SS	Stainless Steel		
 <p>In-Ground w/Trim Ring</p>		996132	IGT049-AB	Antique Brass		
		996130	IGT049-BR	Stainless Steel		
		996100	IGT049-CB	Composite Black		
		996134	IGT049-SS	Stainless Steel		
 <p>Hanging Light</p>		997402	HLS043-AB	Antique Brass		
		997400	HLS043-BR	Brass		
		997404	HLS043-CU	Copper		
 <p>Well Light</p>		996300	WPO055-CB	Composite Black		 <p>PAR36WFL4/827/IP67/LED - 81074 PAR36WFL6/827/IP67/LED - 81075 PAR36WFL12/827/IP67/LED - 81076</p>

Lamp Guide

Style	Size	Item #	Product Code	Finish	LED Lamp Product Code
 Step Light with Trim		942005	SBT048-BR	Brass	         
		942006	SBT048-CU	Copper	
		942007	SBT048-SS	Stainless Steel	
		942004	SPT048-TB	Textured Black	
		942003	SPT048-TZ	Textured Bronze	
 Step Light with Louver		942505	SBL048-BR	Brass	
		942506	SBL048-CU	Copper	
		942507	SBL048-SS	Stainless Steel	
		942504	SBL048-TB	Textured Black	
		942533	SBL048-TZ	Textured Bronze	
 Deck Post Light		997104	DPL033-AB	Antique Brass	
		940002	DPL033-TB	Textured Black	
		940003	DPL033-TZ	Textured Bronze	
 Deck Under-Step	6"	941002	DUS060-AB	Antique Brass	  
		941000	DUS060-CU	Copper	
		941001	DUS060-SS	Stainless Steel	
	12"	941012	DUS120-CU	Copper	
		941013	DUS120-SS	Stainless Steel	



DecoStrand™

Outdoor String Lights

Decorative accent strand lighting for indoor/outdoor use that accepts multiple lamp options including LED, incandescent, and specialty color.

DSL/52254M/3G-BK

Overall Length	52 ft.
Gauge Type	Heavy Duty 14 Gauge
Number of Sockets	25
Socket Type	Medium Base
Drop Distance	4 in.
Wiring	52 ft. 3-Wire Grounded
Lamp	Lamps Sold Separately
Volts	120V
Warranty	2 Year Limited

Order Codes

Strand Lighting	DSL/52254M/3G-BK
Steel Reflector	DSL/FSTR-NF



DSL/52254M/3G-BK with DSL/FSTR-NF



DSL/52254M/3G-BK



Natural Finish

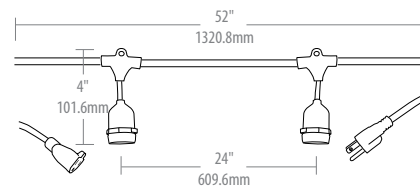

Recommended Lamps



Part Number	80522	20006	9051	20002
Product Code	S14CL1C/827/LED	ST18ANT40	S14CL11	A21ANT40
Watts	1.4	40	11	40
Color Temp	2700K	2500K		2500K

For the complete ProLED offering of lamps see HalcoLighting.com

Commercial Transformers



TR15SS-600



TR15SS-600

Max VA	Order Codes
100VA	TR15SS-100
200VA	TR15SS-200
300VA	TR15SS-300
600VA	TR15SS-600
900VA	TR15SS-900
1200VA	TR15SS-1200

TR15SS-100 - 5.25" (133.35mm)
 TR15SS-200 - 5.25" (133.35mm)
 TR15SS-300 - 5.25" (133.35mm)
 TR15SS-600 - 6.75" (171.45mm)
 TR15SS-900 - 8" (203.2mm)
 TR15SS-1200 - 6.25" (158.75mm)

TR15SS-100 - 11.00" (279.4mm)
 TR15SS-200 - 11.00" (279.4mm)
 TR15SS-300 - 11.00" (279.4mm)
 TR15SS-600 - 12.5" (311.15mm)
 TR15SS-900 - 13.5" (342.9mm)
 TR15SS-1200 - 17.5" (444.5mm)

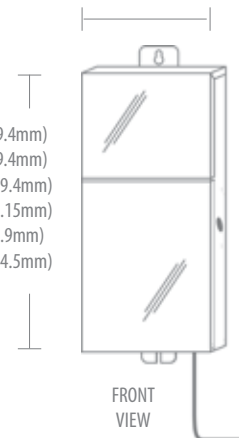

TR15SS-100 - 5.0" (127mm)
 TR15SS-200 - 5.0" (127mm)
 TR15SS-300 - 5.0" (127mm)
 TR15SS-600 - 6.25" (158.75mm)
 TR15SS-900 - 7.25" (184.15mm)
 TR15SS-1200 - 6.75" (171.45mm)

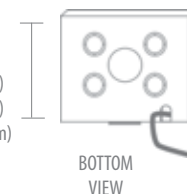

- Corrosion-resistant stainless steel
- Lockable, hinged door
- Bottom panel contains 1½" conduit inlet and (4) ¾" knockouts for low voltage exit
- Input voltage: 120V
- Output voltage taps: 12/13/14/15V
- TR15SS-1200 also has 17,20 and 22V taps
- In-line primary overload protection prevents system damage with auto thermal shut-off
- UL 1830 Listed
- In-line secondary magnetic breaker prevents short circuit protection with reset
- Mounting brackets are located on top and bottom of the console
- Plug-in ready
- 6-foot, grounded, water-resistant, heavy gauge power cord
- Approved for use with submersion luminaires
- Limited lifetime warranty

Integrated Transformers



TR15SS-INT-300



TR12PC-INT-100



TR12SS-INT-120
TR12SS-INT-200

Max VA	Voltage Taps	Order Codes
100VA	12V	TR12PC-INT-100
120VA	12V	TR12SS-INT-120
200VA	12V	TR12SS-INT-200
300VA	12V, 13V, 14V, 15V	TR15SS-INT-300

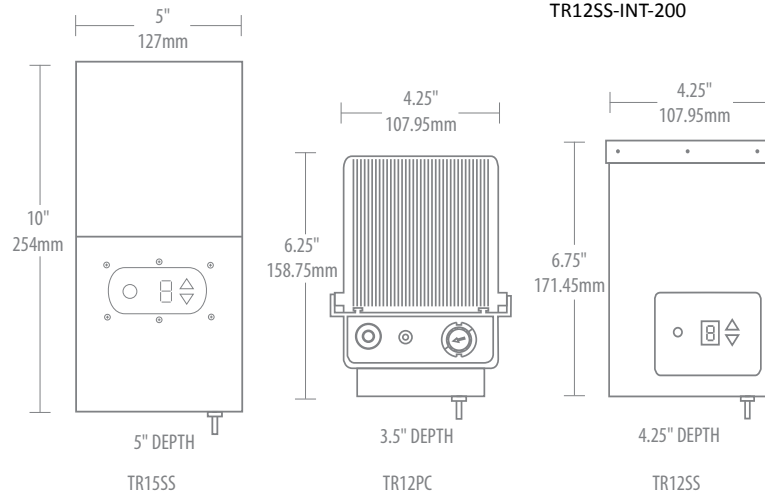

- Corrosion-resistant stainless steel finish (TR12SS)
- Black polycarbonate finish (TR12PC)
- Integral photocell and timer allow light fixtures to operate manually, automatically or on a timer
- Automatic operation turns lights on at dusk and off at dawn
- TR12PC Timer turns lights on at dusk and turns them off 4 hours, 6 hours or 8 hours after dusk
- UL 1830 Listed
- TR12SS Timer turns lights on at dusk and turns them off 1 to 9 hours after dusk
- Resettable circuit breaker prevents overloads and short circuits
- Plug-in ready with 6-foot, grounded, water-resistant, heavy gauge power cord
- Limited 2-year warranty

Accessories

Simple, elegant designs in Antique Brass, Brass, Copper and Stainless Steel natural metals and Textured Black and Textured Bronze powdercoat aluminum finishes complement & enhance landscape settings



TMA

Analog Timer

24-hour clock
3 on/off settings per day



TMDA

Digital Astronomic Timer

Build-in daylight saving time function
Auto adjusts to sunrise/sunset for dusk/dawn settings



DMT027

Deck Mount

2.7"
Antique Brass (AB)
Brass (BR)
Textured Black (TB)
Textured Bronze (TZ)



GS08
GS12

Ground Stake

8" Black ABS
12" Black ABS
Slot cutout for wires



PCS

Photocell

6" Lead

ProLED® Volt-Ampere Guide

Selecting a Transformer for LED Lighting Installations

Halco ProLED lamps are more efficient and have significantly longer life compared to traditional light sources while providing high quality light. Unlike halogen and incandescent lamps, which produce light by heating a filament, light from LED lamps is produced by the energy that results from forcing electrons through a semiconductor material.

True power consumed is measured in watts and is what customers are charged for on their utility bill. A lamp's true power (wattage) is listed on the lamp's packaging. When an LED is powered, the lamp's driver converts alternating current (AC) to direct current (DC), which consumes reactive and harmonic power on top of the true power that is required to produce light. The utility must generate additional energy above and beyond the lamp's true power in order to operate the lamp. The total amount of power that must be generated by the utility is measured in volt-amperes (VA) and is referred to as apparent power. Power factor - the ratio of true power to apparent power - is the measure of how efficiently electrical power is consumed. Dividing a lamp's wattage by the lamp's power factor results in the VA drawn on the line:

Wattage/Power Factor = Volt-Amperes

Halogen and incandescent lamps have a power factor of one, which means that the lamp uses 100% of the input power to produce light and heat. Consequently, filament lamps' wattage and VA are equivalent. For example, a 20W MR16 BAB draws 20VA from the line.

For LED installations, apparent power (VA) must be taken into consideration because transformer size is actually based on apparent power (VA), not true power (W). To specify the correct transformer size, the system's total load must be calculated to ensure that the total volt-ampere draw does not exceed the transformer's rating.

The LED installation example below shows system load (total VA), true power consumed (W) and annual energy cost calculations.

1. Calculate Load of LED System

	Lamp VA	x # Lamps	= Total Fixture Load
Well Light with 10W ProLED PAR36	12.0	8	= 96.0
Modern Bullet with 4.5W ProLED MR16	5.5	4	= 22
Total System Load			118

2. Select the Applicable Transformer for the LED System Load

- TR12PC-INT-100
 TR12SS-INT-200
 TR15SS-300
 TR15SS-900
 TR12SS-INT-120
 TR15SS-INT-300
 TR15SS-600
 TR15SS-1200

3. Calculate LED Energy Consumption

	Lamp Wattage	x # Lamps	= Power Consumption
Well Light with 10W ProLED PAR36	10	8	= 80
Modern Bullet with 4.5W ProLED MR16	4.5	4	= 18
Total System Power Consumption			98

4. Calculate the LED System's Annual Energy Cost

Consumption	x Utility Cost ¹	x Annual Operating Hours ² /1000	= Annual Energy Cost
98W	\$0.115 kWh	2190 hrs	= \$24.68

¹Utility Cost based on national average per U.S. Energy Information Administration <http://www.eia.gov/electricity/data.cfm#summary> at the time of printing.

²Annual Operating Hours based on 6 hours/day and 365 days/year.



Strongest Lamp Warranty

20
Year
Warranty

When installed in a Sollos fixture in recommended conditions and packaging warnings are followed, ProLED MR16 and IP65-rated JC lamps are backed by a 20-year limited warranty, the strongest lamp warranty in the industry. When installed in other fixtures, these lamps are backed by a 5-year Limited Warranty. ProLED 912 lamps and non-IP65-rated JC lamps are backed by a 2-year Limited Warranty.

Think Lumens!

Efficient lighting technologies such as LED and compact fluorescent lamps produce comparable light output while consuming considerably less energy than traditional light sources. When evaluating replacement lamps, refer to lamps' light output, which is measured in lumens, rather than wattage. Lamps with relatively equivalent lumens and CBCP will provide similar illumination. So think lumens for light output and use lamp wattage to determine energy savings.

Warranty

Sollos Landscape Lighting (hereinafter called "Sollos"), 2940 Pacific Drive, Norcross, GA 30071, warrants to the original purchaser that Sollos fixtures will be free from defects in materials and or workmanship for five years from the date of purchase except as indicated below:

<u>Category</u>	<u>Warranty</u>
Integrated transformers	2 Years
Commercial grade transformers	Lifetime
Brass fixtures	Lifetime
Antique Brass fixtures	Lifetime
Copper fixtures	15 Years
Stainless Steel fixtures	Lifetime
Architectural Aluminum fixtures	5 Years
Composite fixtures	5 Years

EXPLICIT OPERATING CONDITIONS:

All products must be installed according to Sollos Installation Instructions and ProLED lamps must be operated in recommended conditions. This warranty is issued to the original purchaser and is non-transferable.

Should any product fail to meet the warranty specified above, Sollos, at its option, shall correct any defect by repair or replacement. This warranty is conditioned upon proper storage, installation, use and maintenance. Remedy is expressly limited to repair or replacement only.

This warranty is not applicable to any product subjected to abnormal stresses and operating conditions.

Sollos reserves the right to examine all products prior to the determination of warranty status.

All products must be retained for warranty claims. The warranty period starts on the date of original purchase.

NO IMPLIED STATUTORY WARRANTY OF MERCHANTABILITY OR FITNESS FOR A PARTICULAR PURPOSE SHALL APPLY BEYOND THE AFOREMENTIONED WARRANTY PERIOD.

The foregoing warranty is exclusive of all other statutory, written or oral warranties, and no other warranties of any kind, statutory or otherwise, are given or herein expressed. The warranty sets forth Sollos' responsibilities regarding the products and claimant's exclusive remedy.

LIMITATION OF LIABILITY

Sollos will not under any circumstances, whether as a result of breach of contract, breach of warranty, tort, strict liability or otherwise, be liable for consequential, incidental, special or exemplary damages including, but not limited to, loss of profits or revenues, loss of use of product or any other goods or associated equipment or damage to any associated equipment, cost of capital, cost of substitute products, facilities of service, down time cost, or claims of claimant's customers. Sollos' liability on any claim of any kind for any loss or damages arising out of, resulting from or concerning any aspect of this agreement from the products or services furnished hereunder shall not exceed the price of the specific product or lamps which gives rise to the claim.

Some states do not allow the exclusion or limitation of damages or the length of time for an implied warranty. Therefore, the limitations or exclusions of consequential or incidental damages and implied warranties may not apply to certain claimants. This warranty gives the claimant specific legal rights. The claimant may also have other rights, which vary from state to state.

sollos®

LANDSCAPE LIGHTING
A Halco Lighting Technologies Company



Sollos Landscape Lighting

2940 Pacific Drive Norcross GA 30071

P.O. Box 1368 Norcross GA 30091-1368

Toll Free 888-976-5567 | Fax 888-576-5567

solloslighting.com