

Electrical Box

Non-Metallic Device Box

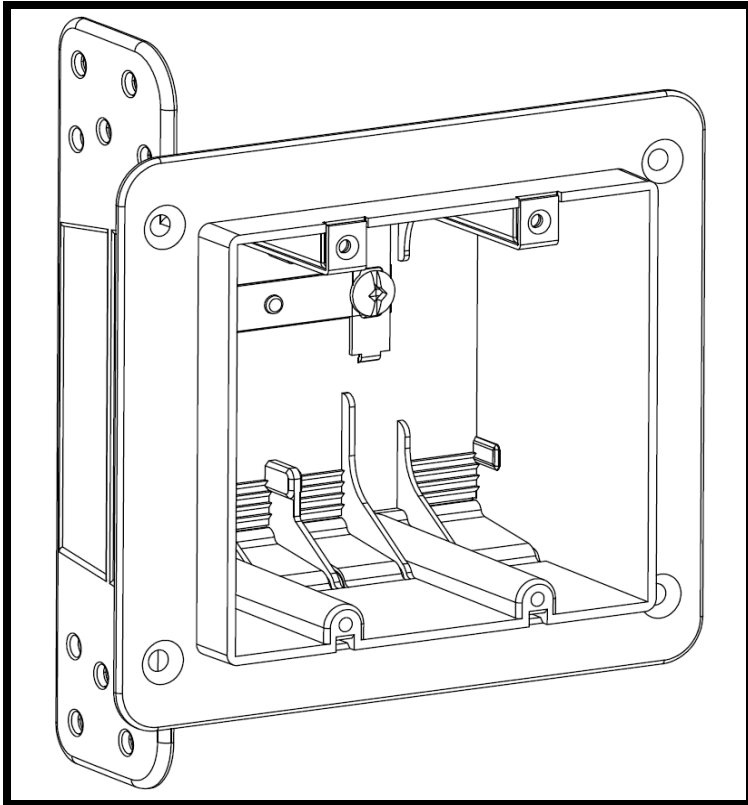

DESCRIPTION	PRODUCT #	COLOUR
-------------	-----------	--------

2-Gang Device Box	20472	Grey
-------------------	-------	------

FEATURES:

- Non-gangable non-metallic device box
- 3½" High x 3⅝" Wide x 2⅝" Deep
- 37cu.in. volume
- Prepositioned depth tabs for ½" drywall mounting
- Markings for ⅝", 1", and 1⅛" drywall mounting
- 8 x Self-clamping NMD90 cable clamps (14-10AWG)
- 6-32 Device mounting holes (3.28in. apart)
- 2 x 8-32 Ground screw
- 10 x Mounting holes for box mounting



20472

TESTING & CODE COMPLIANCE:

- UL STD 514C 1996, CSA Standard C22.2 No. 18.2-06
- ETL file No. 5000535



MATERIAL CHARACTERISTICS:

- Polycarbonate ABS
- Environmental: Flammability UL94, V-0 Rating
- Operating Temperatures: From -40°C (without impact) to 95°C maximum continuous