

Dual Function Circuit Breaker



NGB Circuit Breakers



QR Circuit Breakers

contents

What's New in Circuit Breakers	7-3 – 7-4
Federal Specifications Classification	7-5
Catalog Numbering System	7-6 – 7-8
Reference Guides	7-9 – 7-18
Load Center Breakers	
Arc Fault and Ground Fault Breakers	7-19
QP, 1 Inch Breakers	7-20
QT, ½ Inch Breakers	7-21
Special Application Breakers	7-22
QD ¾ Inch Breakers	7-23
Main and Branch Breakers	7-24 – 7-25
Circuit Breaker Dimension Drawings	7-26
Circuit Breaker Lug Data	7-27
Surge Protection	7-28
Panelboard Mounted Circuit Breakers	
BL 240V Breakers	7-29
BL 240V Arc Fault and Ground Fault Breakers	7-30
Special Application 240V Panelboard Mounted Breakers	7-31
BQD 100A Frame 480/277V Breakers	7-32
GB 125A Frame 600/347V Breakers	7-33
NGB2 125A Frame 600/347V Breakers	7-34
Internal Accessories for BQD and NGB Breakers	7-35
General Application Circuit Breakers	
BQ 240V Breakers	7-36
BOXD 240V DIN Rail Mounting Breakers	7-37
QR250 Frame 240V Breakers	7-38
CQD 100A Frame 480/277V Breakers	7-40
GG 125A Frame 600/347V Breakers	7-41
Internal Accessories for CQD and NGG Breakers	7-42
EG 125A Frame 600/347V Breakers and Internal Accessories	7-43 – 7-44
Sentron Thermal Magnetic and Electronic Circuit Breakers	
ED 125A Frame 600V Breakers and Internal Accessories	7-45 – 7-47
FD 250A Frame 600V Breakers and Internal Accessories	7-48 – 7-50
JD/SJD 400A Frame Breakers and Internal Accessories	7-51 – 7-54
LD/SLD 600A Frame Breakers and Internal Accessories	7-55 – 7-58
LMD 800A Frame Breakers and Internal Accessories	7-59 – 7-61
MD/SMD 800A Frame Breakers and Internal Accessories	7-62 – 7-65
ND/SND 1200A Frame Breakers and Internal Accessories	7-66 – 7-69
PD/SPD 1600A Frame Breakers and Internal Accessories	7-70 – 7-72
RD 2000A Frame Breakers and Internal Accessories	7-73
Magnetic Trip Only – ETI Motor Circuit Protectors	7-74 – 7-76
Adjustable Instantaneous Magnetic Trip Settings	7-77 – 7-79
Molded Case Switch – Circuit Disconnect	7-80
Digital Solid State Sentron Sensitrip IV Series Trip Units	7-81 – 7-82
WL Power Circuit Breakers	7-83 – 7-86
Lug Information	7-87 – 7-89
Breaker Modifications	7-90
Internal Accessories – Feature Combinations	7-91
External Accessories	7-94 – 7-99
Unusual Operating Conditions	7-100 – 7-101

(continued on next page)

Scan to connect online to the most up-to-date version of this Section of SPEEDFAX.





contents

VL Thermal Magnetic and Electronic Circuit Breakers

Technical Overview	7-103 – 7-104
Trip Unit Overview	7-105 – 7-106
DG 150A Frame and Internal Accessories	7-107 – 7-110
FG 250A Frame and Internal Accessories	7-111 – 7-114
JG 400A Frame and Internal Accessories	7-115 – 7-118
LG 600A Frame and Internal Accessories	7-119 – 7-122
MG 800A Frame and Internal Accessories	7-123 – 7-126
NG 1200A Frame and Internal Accessories	7-127 – 7-130
PG 1600A Frame and Internal Accessories	7-131 – 7-133
Molded Case Switch	7-134
Motor Circuit Protector	7-135
VL 600 Volt DC Circuit Breakers	7-136
External Accessories	7-137 – 7-151
Accessory Locations	7-152
Suffix for Factory Mounted Internal Accessories	7-153
Technical Data	7-154 – 7-155
Unusual Operating Conditions	7-156 – 7-157

General Technical

Series Short Circuit Ratings	7-158 – 7-168
Sentron IEC 94702 AC Interrupting Ratings	7-169
Typical Specifications	7-170
Superseded Circuit Breakers	7-171 – 7-173

Molded Case Circuit Breakers

Introduction

What's **new** in molded case circuit breakers:



New Sentron Sensitrip

Sentron Sensitrip IV ETU Circuit Breakers with Integrated DAS / Maintenance Mode

Design enhancements include:

- Upgraded ETU for NEC 240.87 code compliance (Arc Energy Reduction)
- Frame ratings from 400A to 1600A
- Identical footprint, kAIC ratings and accessory offering as legacy Sensitrip III ETU breakers to ease integration / retrofit
- Maintenance mode versions require customer-supplied 24V external power supply, maintenance switch and light

The New Siemens QR Circuit Breaker

Implemented in load centers, panelboards, switchboards, meter centers, and modular metering, the new QR breaker is the same form-factor/ mounting as QJ breaker for easy retrofit.

Design enhancements include:

- Trip unit ratings from 100A to 250A.
- Field installable internal accessories – shunt trip, aux switch or shunt/aux combo.
- Two accessory pockets in 3-pole breakers. One accessory pocket in 2-pole breakers.
- High in-rush current capability (450%).
- Push-to-trip button.



The development of **VL Circuit Breaker enclosures** for the 150A and 250A breakers demonstrates a significant enhancement of the Siemens product offering. The fundamental objective of this family of enclosures is to reduce installation cost of the breaker, as well as reducing the space required for low amperage breaker enclosures.

The **Dual Function Circuit Breaker** combines GFCI and AFCI, protecting against both Arc Faults and Ground Faults. This, along with the new Self-Test & Lockout feature, makes it the first in class in electrical safety for homeowners.

- Faster Installation
- Cost savings
- Smaller Device
- Self Test & Lockout feature as required by UL 943 effective June 2015



The Siemens GG circuit breaker is a compact, industrial design thermal magnetic breaker with valuable features for the global markets. These features include a design that meets multi-national standards, is suitable for DIN rail or base mounting without the need for adapters, and includes UL listed field installable accessories. The GG also has an over center toggle mechanism that is trip free and uses repulsion contact arm construction. Therefore, should a short circuit or tripping condition occur, the contacts are forced apart and the breaker cannot be held closed by means of the handle.



Ordering

In the FD through RD frames, you may order molded case circuit breakers three basic ways:

- As separately ordered frames, trip units and lugs
- As frame, trip unit and lugs ordered as one catalog number and shipped unassembled or assembled
- As Frame and Trip Unit shipped assembled and with the trip unit made non-removable, in compliance with UL 489 requirements that to be reverse fed the circuit breaker must not have an interchangeable trip unit.

These two options are described in the following:

Components Ordered Separately

To get the components for a 3-pole, 400 Amp standard interrupting circuit breaker, you would order the frame (JD63F400), the trip unit (JD63T400) and six lugs (TA2J6500). This option is normally useful only if you stock and use large volumes of product and wish to reduce your inventory cost. You may stock, for example, a smaller number of frames (JD63F400) and a variety of trip units (JD63T300, JD63T350, etc.) and assemble breakers as you need them.

Frame, Trip Unit and Lugs Ordered Together

If you order the catalog number JD63B400, you will receive a frame, a trip unit and 6 lugs in separate packages. By suffixing this number with "L" (e.g. JD63B400L), you will receive frame, trip unit and lugs assembled in one container. Pursuant to UL 489, a product ordered thus will have the markings "LINE" and "LOAD", and may not be "reverse fed" (with power flowing from the "OFF" end of the breaker toward the "ON" end).

Non-Interchangeable Trip Breakers

If you place an "X" after the frame size designator (e.g. JXD63B400), you will receive a frame and trip unit assembled, with the trip unit made non-removable. If you suffix an "L" to this catalog number (e.g. JXD63B400L), you will receive the breaker, non-removable trip unit and lugs assembled. Unless you anticipate a specific need to change the breaker's ampere rating in the future, this is the preferred ordering method, as the products are assembled to Siemens' specifications in our factories. These breakers are suitable for use reverse fed according to UL 489, since the trip unit is not removable.

The smaller frames (QJ, ED and below) do not have removable trip units, and consequently are shipped only as assembled products. To add lugs, see the ordering instructions on each product's catalog page.

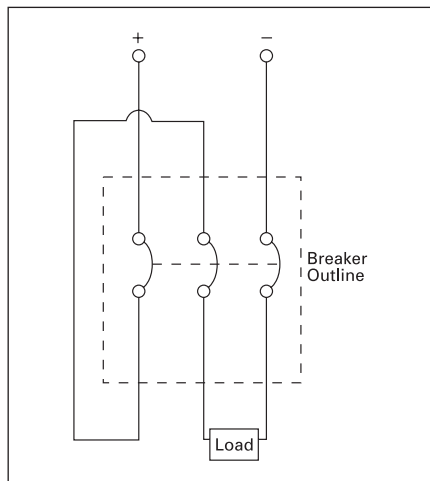

500V DC Wiring Configuration

Connecting Breakers for DC Application

Most Siemens thermal magnetic trip MCCBs are applicable on direct current (dc) systems. Generally, for 250 V dc systems a two pole breaker is used, with one pole on each leg of the supply circuit. For three pole breakers applied on 500 V undergrounded DC systems, it is important to connect the power supply "zig-zag" through the breaker as shown in the figure below. This assures that the Voltage between phases on the breaker terminals is uniformly distributed.

See below for an alternative connection diagram. For a list of Sentron breakers with the DC ratings, please refer to pages 7-11 to 7-16.

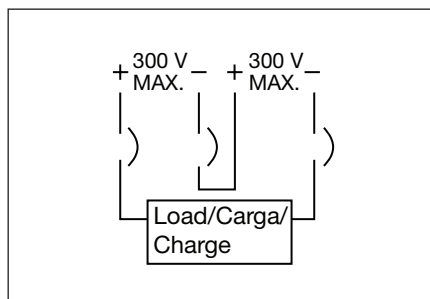

Molded Case Circuit Breakers

Federal Specification Classification

Reference

W-C-375C/GEN

Class	Interrupting Rating		Poles	Range of Current Trip ^③	Breaker Type (All Circuit Breakers Meet or Exceed the Indicated Class Level)
	Symmetrical Amperes ^①	Volts AC 60HZ			
10a ^②	5,000	120/240	1 or 2	15–100	QP, BQ, QT, BL
10b	5,000	240	2 or 3	15–100	QP, BQ, BQD, CQD, BL
11a	7,500	120	1	15–100	QP, BQ, BQD, CQD, BL
11b	7,500	240	2 or 3	15–100	QP, BQ, BQD, CQD, BL
12a ^②	10,000	120/240	1 or 2	15–100	QP, BQ, QT, ED2, BL
12b	10,000	240	2 or 3	15–225	QP, BQ, QJ2, ED2, BQD, CQD, BL
12c	10,000	277	1	15–100	BQD, CQD, NGG, NGB, NEG, NEB
13a	14,000	277	1	15–100	ED4, BQD, CQD, NGG, NGB, NEG, NEB
13b	14,000	277/480	1, 2, or 3	15–100	ED4, BQD, CQD
14a	22,000	120/240	1 or 2	15–100	QPH, BQH, BLH
14b	22,000	240	2 or 3	70–400	QJH2, QJ2-H, BQH, BQD, CQD, BLH
15a	65,000	120/240	1 or 2	15–100	HQP, HBQ, ED4, HED4, NGG, NGB
15b	65,000	240	2 or 3	15–225	ED6, ED4, FXD6, FD6, HED4, BQD, CQD, HQJ2H, NGG, NGB, NEG, NEB
16a	100,000	480	2 or 3	15–225	CFD6, CED6
16b	100,000	600	2 or 3	15–600	CED6, CFD6, CJD6, SCJD6, CLD6, SCLD6
17a	200,000	600	2 or 3	70–2000	—
18a	18,000	240	2 or 3	15–125	ED6, HED6, HHED6
	14,000	480			
	14,000	600			
19a	22,000	240	2 or 3	70–225	FXD6, FD6, CFD6, HFD6
	18,000	480			
	14,000	600			
20a	25,000	240	2 or 3	70–225	FXD6-A, FD6-A, CFD6, HFD6
	22,000	480			
	22,000	600			
21a	42,000	240	2 or 3	70–800	HFD6, CFD6, JXD6(A), JD6(A), SJD6-B, HJD(A), HJXD6(A), HHJD6, SHJD6-B, CJD6, SCJD6-B, LXD6(A), LD6(A), SLD6-B, HLD6(A), HLXD6(A), HHL6, SLD6-B, SHLD6-B, CLD6, SCLD6-B, LMD6, LMXD6, HLMD6, HLMXD6, MD6, MXD6, SMD6-B, HMD6, HMXD6, SHMD6-B, CMD6, SCMD6-B
	30,000	480			
	22,000	600			
22a	65,000	240	2 or 3	15–125	CED6, ED6, HED6, HHED6, FXD6-A, FD6-A
	25,000	480			
	18,000	600			
23a	65,000	240	2 or 3	70–1200	HHED6, FXD6-A, FD6-A, HFD6, HHFD6, CFD6, JD6(A), JXD6(A), SJD6-B, HJD(A), HJXD6(A), SHJD6-B, HHJD6, HHJXD6, CJD6, SCJD6-B, LXD6(A), LD6(A), SLD6-B, HLD6(A), HLXD6(A), SHLD6-B, HHL6, HHLXD6, CLD6, SCLD6-B, LMD6, LMXD6, HLMD6, HLMXD6, MD6, MXD6, SMD6-B, HMD6, HMXD6, SHMD6-B, CMD6, SCMD6-B, ND6, NXD6, SND6-B, HND6, HNXD6, SHND6-B, CND6, SCND6-B
	35,000	480			
	25,000	600			
24a	65,000	240	2 or 3	1200–2000	PD6, PXD6, HPD6, HPXD6, CPD6 RD6, RXD6, HRD6, HRXD6, SPD6-B, SHPD6-B
	50,000	480			
	42,000	600			
25a	125,000	240	2 or 3	600–4000	HHL6, CLD6, CMD6, CND6 SCLD6-B, SCMD6-B, SCND6-B, CPD6
	80,000	480			
	60,000	600			

Applicable Standards

UL489 — Molded Case Circuit Breakers and Circuit Breaker Enclosures.

UL486A — Wire Connectors and Solderless Lugs for use with copper wire

UL486B — Wire Connectors and Solderless Lugs for use with aluminum wire

UL943 — Ground Fault Interrupters (for personnel protectors)

UL1087 — Molded Case Switches

UL50 — Cabinets and Boxes

UL869 — Service Equipment

NEMA AB-1 — Molded Case Circuit Breakers and Molded Case Switches

CSA-C22.2 No. 5, C22.2 No. 14

Note:

- (A) Molded case circuit breakers are designed and tested in accordance with applicable portions of UL489 and meet application requirements of the National Electric Code. Unless marked otherwise, circuit breakers are 80% duty rated.
(B) Molded case circuit breakers are to be connected with 60 or

75°C wire for circuit breakers having a rated ampacity of 100 amperes or less. Circuit breakers having a rated ampacity greater than 100 amperes shall only be cabled with 75°C cable unless otherwise indicated on the circuit breaker label. Exceptions to this rule are outlined in the article 110-14 C(1)(2) of the 2005 National Electric Code.

① Interrupting ratings are not limited to the values or groups of values listed. However, the values listed are minimum values for the class specified.

② Single-unit or duplex construction must be specified.

③ Use minimum frame size for ampere rating.

Sentron Molded Case Circuit Breakers

Catalog Numbering System

Selection/Application

If used on 250A frame and above means non-interchangeable trip breaker with factory assembled frame and trip. Solid state trip and current limiting (S or C in first character) are non-interchangeable only, and the "X" is omitted.

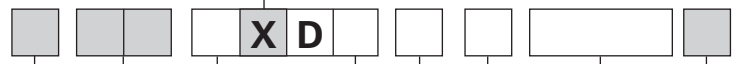

Trip Unit Type

- Omitted — Thermal-Magnetic
- S — Sensitrip® Electronic Trip

Sentron Series Type/Interrupting Range

- Omitted — Standard Rating
- H — High IC Rating
- HH — Extra High IC Rating
- C — Highest IC Rating and Current Limiting

Frame Identifier

- E — Type ED
- F — Type FD
- J — Type JD
- L — Type LD
- LM — Type LMD
- M — Type MD
- N — Type ND
- P — Type PD
- R — Type RD

Maximum Voltage

- 2 — 240 Vac
- 4 — 480 Vac
- 6 — 600 Vac

Number of Poles

- 1
- 2
- 3
- A — used to indicate advanced electronic trip unit with maintenance mode capability (always 3 poles)
- B — used to indicate basic electronic trip unit (always 3 poles)

(Specific Application Type)

- B — Standard 40°C Breaker
- M — Calibrated for 50°C Application
- F — Frame Only
- T — 40°C Trip Unit Only
- W — 50°C Trip Unit Only
- S — Molded Case Switch
- L — Low Instantaneous Range ETI Breaker
- A — Standard Range ETI Breaker
- H — High Instantaneous Range ETI Breaker

Maximum Continuous Current Rating

- ED Frame — 015, 020, 025, 030, 035, 040, 045, 050, 060, 070, 080, 090, 100, 110, 125
- FD Frame — 070, 080, 090, 100, 110, 125, 150, 175, 200, 225, 250
- JD Frame — 200, 225, 250, 300, 350, 400
- LD Frame — 250, 300, 350, 400, 450, 500, 600
- LMD Frame — 500, 600, 700, 800
- MD Frame — 500, 600, 700, 800
- ND Frame — 900, 100 (1000A), 120 (1200A)
- PD Frame — 120 (1200A), 140 (1400A), 160 (1600A)
- RD Frame — 160 (1600A), 180 (1800A), 200 (2000A)

Suffix

- L — where applicable indicates a breaker shipped with line/loads lugs installed
- A — used with a switch to show automatic self protection
- Y — 400 Hertz
- H — 100% rated
- P — Load side lugs only
- NAV — Navel Ratings

NOTE:

- Position omitted if not used.

VL Molded Case Circuit Breakers

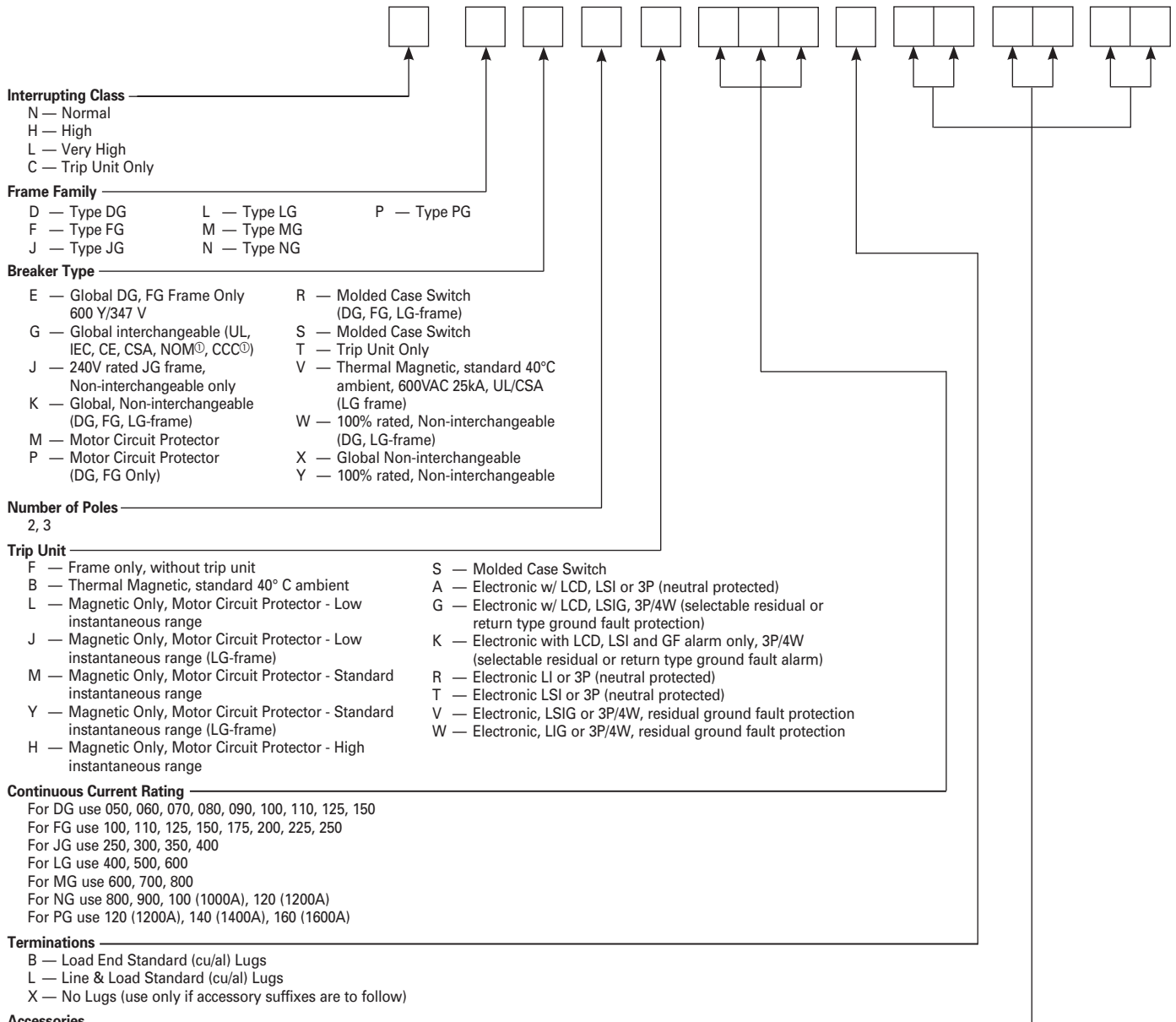

Interrupting Class

- N — Normal
- H — High
- L — Very High
- C — Trip Unit Only

Frame Family

- D — Type DG
- F — Type FG
- J — Type JG
- L — Type LG
- M — Type MG
- N — Type NG
- P — Type PG

Breaker Type

- E — Global DG, FG Frame Only 600 Y/347 V
- G — Global interchangeable (UL, IEC, CE, CSA, NOM[®], CCC[®])
- J — 240V rated JG frame, Non-interchangeable only
- K — Global, Non-interchangeable (DG, FG, LG-frame)
- M — Motor Circuit Protector
- P — Motor Circuit Protector (DG, FG Only)
- R — Molded Case Switch (DG, FG, LG-frame)
- S — Molded Case Switch
- T — Trip Unit Only
- V — Thermal Magnetic, standard 40°C ambient, 600VAC 25kA, UL/CSA (LG frame)
- W — 100% rated, Non-interchangeable (DG, LG-frame)
- X — Global Non-interchangeable
- Y — 100% rated, Non-interchangeable

Number of Poles

- 2, 3

Trip Unit

- F — Frame only, without trip unit
- B — Thermal Magnetic, standard 40° C ambient
- L — Magnetic Only, Motor Circuit Protector - Low instantaneous range
- J — Magnetic Only, Motor Circuit Protector - Low instantaneous range (LG-frame)
- M — Magnetic Only, Motor Circuit Protector - Standard instantaneous range
- Y — Magnetic Only, Motor Circuit Protector - Standard instantaneous range (LG-frame)
- H — Magnetic Only, Motor Circuit Protector - High instantaneous range
- S — Molded Case Switch
- A — Electronic w/ LCD, LSI or 3P (neutral protected)
- G — Electronic w/ LCD, LSIG, 3P/4W (selectable residual or return type ground fault protection)
- K — Electronic with LCD, LSI and GF alarm only, 3P/4W (selectable residual or return type ground fault alarm)
- R — Electronic LI or 3P (neutral protected)
- T — Electronic LSI or 3P (neutral protected)
- V — Electronic, LSIG or 3P/4W, residual ground fault protection
- W — Electronic, LIG or 3P/4W, residual ground fault protection

Continuous Current Rating

- For DG use 050, 060, 070, 080, 090, 100, 110, 125, 150
- For FG use 100, 110, 125, 150, 175, 200, 225, 250
- For JG use 250, 300, 350, 400
- For LG use 400, 500, 600
- For MG use 600, 700, 800
- For NG use 800, 900, 100 (1000A), 120 (1200A)
- For PG use 120 (1200A), 140 (1400A), 160 (1600A)

Terminations

- B — Load End Standard (cu/al) Lugs
- L — Line & Load Standard (cu/al) Lugs
- X — No Lugs (use only if accessory suffixes are to follow)

Accessories

Auxiliary and Alarm Switch Combinations

- | Suffix | Description |
|--------|--|
| A1 | 1 Alarm (includes 1NO & 1NC switch with a 2 Aux./1 Alarm Base, for frames DG to LG) |
| A2 | 2 Aux (1NO & 1NC switch with a 3 Aux. Base, for frames DG to LG) |
| A3 | 2 Aux + 1 Alarm (2NO & 2NC switches with a 2 Aux./1 Alarm Base, for frames DG to LG) |
| A3 | 2 Aux + 2 Alarm (2NO & 2NC switches with a 2 Aux./2 Alarm Base, for frames MG to PG) |
| A4 | 4 Aux (2NO & 2NC switches with a 4 Aux. Base, for frames MG to PG) |

Shunt Trips

- | | |
|------------------|------------------|
| RB — 24 VDC | RM — 48-60 VAC |
| RC — 48-60 VDC | RN — 110-127 VAC |
| RD — 110-127 VDC | RS — 208-277 VAC |
| RE — 250 VDC | RV — 380-600 VAC |

Under Voltage Releases

- | | |
|------------------|------------------|
| UA — 12 VDC | UN — 110-127 VAC |
| UB — 24 VDC | UP — 208 VAC |
| UC — 48 VDC | UR — 220-250 VAC |
| UD — 110-127 VDC | US — 277 VAC |
| UE — 220-250 VDC | UT — 380-415 VAC |
| UG — 60 VDC | UU — 440-480 VAC |
| UK — 24 VAC | |

Note: A1 and A3 include 1NO and 1NC switch for alarm purposes, only one of these switches may be used as there is only one space for an alarm.

LCD = Liquid Crystal Display
 LI = Long Delay & Instantaneous trip functions
 LSI = Long Delay, Short Delay, & Instantaneous trip functions
 LSIG = Long Delay, Short Delay, Instantaneous, & Ground Fault trip functions
 GF = Ground Fault
 3P = 3-pole
 4W = 4-wire

© Select Frames

VL Circuit Breakers

If ordering factory-installed accessories or special modifications, you must order a 15-digit catalog number. See the examples below for a detailed explanation. The 15 digit number is achieved by placing X's in positions not being occupied by an accessory/modification. Contact Siemens for circuit breakers configured with accessories.

Auxiliary Switch Example:

H F G 3 B 2 0 0 L **A 2** **X X X X**
Standard 9-digit Aux. Switch Completes Cat #

Shunt Trip / UVR Example:

H F G 3 B 2 0 0 L **X X** **U N** **X X**
Standard 9-digit UVR Completes Cat #

Shunt Trip / Auxiliary Switch Example:

H F G 3 B 2 0 0 L **A 2** **R N** **X X**
Standard 9-digit Aux. Switch Shunt Trip Completes Cat #

Non-Interchangeable Trip Breakers Example:

H F X 3 B 2 0 0 L
Standard 9-digit

Molded Case Circuit Breakers

Thermal-Magnetic Trip Breakers

Page	Plug-In Breakers							Panelboard Breakers						
	QT	QP, QPP ²	QPH, QPPH ³	HQP, HQPP ³	HQPPH ³	QPJ ³	BL ⁴	BLH	HBL	BQD, BQD6	NGB NGB2 ⁵	HGB HGB2 ⁵	LGB LGB2 ⁵	
Ratings	Poles	1, 2	1, 2, 3	1, 2, 3	1, 2, 3 ²	2	2, 3	1,2,3	1,2,3	1,2,3	1,2,3	1,2,3	1,2,3	
	Amperes	15-50	10-125 ³⁽⁴⁾	10-125 ³⁽⁴⁾	10-125 ³⁽²⁾	100-225	150-200	10-125	15-125	15-100	15-100	15-125	15-125	
	Volts (50/60 Hz)	1 Pole	120/240	120/240	120/240	120/240	120/240	120/240	120/240	120/240	120/240	277	347	347
		2 Pole	—	—	—	—	—	—	—	—	—	480/277	600/347	600/347
	UL	3 Pole	—	240	240	240	240	240	240	240	240	480/277	600/347	600/347
		120V	10,000	10,000	22,000	65,000	—	—	10000	22000	65000	65000	—	—
		240V	10,000	10,000	22,000	65,000	100,000	10,000	10000	22000	65000	65000	100000	100000
		277V	—	—	—	—	—	—	—	—	—	14000	—	—
		347V	—	—	—	—	—	—	—	—	—	10000	—	—
		480/277V	—	—	—	—	—	—	—	—	—	14000	25000	35000
		480V	—	—	—	—	—	—	—	—	—	—	25000 ⁵	35000 ⁵
		600/347V	—	—	—	—	—	—	—	—	—	—	14000	22000 ⁵
		600V	—	—	—	—	—	—	—	—	—	—	—	—
		Interrupt Rating Symmetrical RMS Amperes	220/240V	2-Pole I _{cu}	—	—	—	—	—	—	—	—	18000	—
	I _{cs}			—	—	—	—	—	—	—	—	9000	—	—
	380/415V		2, 3-Pole I _{cu}	—	—	—	—	—	—	—	—	—	65000	—
			I _{cs}	—	—	—	—	—	—	—	—	—	33000	—
	500V		2-Pole I _{cu}	—	—	—	—	—	—	—	—	—	—	—
			I _{cs}	—	—	—	—	—	—	—	—	—	18000	—
	DC 125/250 V DC Interrupting Rating	2-Pole	—	—	—	—	—	—	—	—	—	—	—	
3-Pole		—	—	—	—	—	—	—	—	—	—	—		
Dimensions in Inches	Height	10-50A	—	2.87	2.87	—	—	—	3.56	3.56	3.75	4.50	5.00	
		10-60A	3.12	—	—	—	—	—	—	—	—	—	—	
		55-125A	—	3.12	3.12	3.12	3.12	3 ³	3.75	3.75	3.75	4.50	5.00	
	Width	1-Pole	1.00	1.00	1.00	1.00	—	—	1.00	1.00	1.00	1.00	1.00	
		2-Pole	2.00 ¹	2.00 ²	2.00 ²	2.00	4.00 ²	3 ³	2.00	2.00	2.00	2.00	2.00	
		3-Pole	2.00 ¹	3.00	3.00	3.00	—	3.00 ³	3.00	3.00	3.00	3.00	3.00	
Depth	2.06	2.37	2.37	2.37	2.37	2.34	2.37	2.37	2.37	2.69	2.71	2.71		
Overcurrent Devices	Thermal and Fixed magnetic Trip	√	√	√	√	√	√	√	√	√	√	√		
	Thermal and Adjustable Magnetic trip	—	—	—	—	—	—	—	—	—	—	—		
	Adjustable Magnetic trip only	—	—	—	—	—	—	—	—	—	—	—		
	Motor Circuit Protector	—	—	—	—	—	—	—	—	—	—	—		
	Molded Case Switch	—	√ ⁶	—	—	—	—	—	—	—	—	—		
Accessories & Modifications	Undervoltage Trip	—	—	—	—	—	—	—	—	—	—	—		
	Shunt Trip	—	√ ⁶	√ ⁶	√ ⁶	√ ⁶	—	√	√	√	√	√		
	Auxiliary Switch	—	—	—	—	√ ⁶	—	√	√	√	√	√		
	Alarm Switch	—	—	—	—	—	—	—	—	—	—	—		
	Mechanical Interlock	—	—	—	—	—	—	—	—	—	—	—		
	Fungus Proofing (ref. page 7-90)	—	—	—	—	—	—	√	√	√	√	√		
Individual Enclosures	Type 1 - Indoor Surface	√	√	√	√	√	—	—	—	—	—	—		
	Type 1 - Indoor, Flush	—	√	√	√	√	—	—	—	—	—	—		
	Type 3R - Outdoor-Rainproof	—	√	√	√	√	—	—	—	—	—	—		



For inches / millimeters conversion, see Application Data section.
For Plug-in Breakers, see Load Centers & Circuit Breakers section.

① BQD6 CSA certified 10,000A @ 600Y/347V 15-70A only.
② Types QPP, QPPH, HQPP and HQPPH are special 2-pole configurations for metering equipment. Amperage range = 125-225A, width = 4 in.
③ Single pole breakers available in ratings 10-70A only.
④ 125A, 2-pole 120/240V AC only.

⑤ Not applicable to types QPP and QPPH.
⑥ Single pole circuit breakers available in ratings 15-70A only, 125A available as a 2-pole only.
⑦ Not applicable to type HQPP and HQPPH.
⑧ Fits only Siemens EQIII load centers. Breaker is 2 or 3 poles wide.

⑨ 10A, 1-pole & 2-pole 120/240V AC only.
⑩ When two numbers are shown for the xGB/xGB2 column, the top rating is for xGB and the bottom rating for xGB2.
⑪ Applicable for 15-30A breakers only.

Molded Case Circuit Breakers

Reference Guide

Selection/Application

Thermal-Magnetic Trip Breakers

Page			General Purpose Breakers										
			BQ	BQH	HBO	QR2	QRH2	HQR2	HQR2H	CQD	NGG		
Ratings	AC	Poles	1, 2, 3	1, 2, 3	1, 2, 3	2, 3	2, 3	2, 3	2, 3	1, 2, 3	1, 2, 3		
		Amperes, Continuous	1-Pole	15-70	15-70	15-50	—	—	—	—	15-100	15-125	
			2-Pole	15-125	15-100	15-70	100-250	100-250	100-250	100-250	15-100	15-125	
			3-Pole	15-100	15-100	15-100	—	—	—	—	15-100	15-125	
		Volts (50/60 Hertz)	1-Pole	120/240	120/240	120/240	—	—	—	—	277	347	
			2-Pole	—	—	—	—	—	—	—	—	—	
			3-Pole	240	240	240	240	240	240	240	480/277	600/347	
		Interrupt Rating Symmetrical RMS Amperes	UL	120V	10,000	22,000	65,000	—	—	—	—	65,000	65,000
				240V	10,000	22,000	65,000	10,000	25,000	65,000	100,000	65,000	65,000
				480V	—	—	—	—	—	—	—	14,000 ^①	25,000
	600/347V			—	—	—	—	—	—	—	10,000 ^②	14,000	
	IEC 947-2 50/60Hz		220/240V	1-Pole	I _{cu} —	—	—	—	—	—	—	18,000 ^④	25,000
				I _{cs} —	—	—	—	—	—	—	—	9,000 ^④	12,500
			2,3-Pole	I _{cu} —	—	—	—	—	—	—	—	65,000 ^④	65,000
			I _{cs} —	—	—	—	—	—	—	—	—	32,500 ^④	32,500
			380/415V	1-Pole	I _{cu} —	—	—	—	—	—	—	—	—
				I _{cs} —	—	—	—	—	—	—	—	—	—
	500V	2,3-Pole	I _{cu} —	—	—	—	—	—	—	—	18,000 ^④	25,000	
		I _{cs} —	—	—	—	—	—	—	—	—	9,000 ^④	12,500	
	DC	Volts — 2-Pole		—	—	—	—	—	—	—	125/250	125/250	
Interrupting Rating — DC Amperes		—	—	—	—	—	—	—	14,000	14,000			
Dimensions in inches	Height	15-50A	3.75	3.75	4.00	—	—	—	—	4.50	5.40		
		55-125A	4.00	4.00	4.00	—	—	—	—	4.50	5.40		
		60-225A	—	—	—	7.00	7.00	7.00	7.00	—	—		
	Width	1-Pole	1.00	1.00	1.00	—	—	—	—	1.00	1.00		
		2-Pole	2.00	2.00	2.00	3.00	3.00	3.00	3.00	2.00	2.00		
3-Pole		3.00	3.00	3.00	4.50	4.50	4.50	4.50	3.00	3.00			
Depth	—	2.37	2.37	2.37	2.53	2.53	2.53	2.53	2.87	2.90			
Overcurrent Devices	Thermal and Fixed Magnetic Trip		✓	✓	✓	✓	✓	✓	✓	✓	✓		
	Molded Case Switch		✓	—	—	✓	—	—	✓ ^③	—	—		
Accessories & Modifications	Undervoltage Trip		—	—	—	—	—	—	—	—	—		
	Shunt Trip		✓	✓	✓	✓	✓	✓	✓	✓	✓		
	Auxiliary Switch		✓	✓	✓	✓	✓	✓	✓	✓	✓		
	Alarm Switch		—	—	—	—	—	—	—	✓	✓		
	Mechanical Interlock		—	—	—	✓	✓	✓	✓	—	—		
	Fungus Proofing (ref. page 7-90)		✓	✓	✓	✓	✓	✓	✓	✓	✓		
Individual Enclosures	Type 1 — Indoor Surface		✓	✓	✓	✓	✓	✓	✓	—	✓		
	Type 1 — Indoor, Flush		✓	✓	✓	✓	✓	✓	✓	—	✓		
	Type 3R — Outdoor-Rainproof		✓	✓	✓	✓	✓	✓	✓	—	✓		

7
MOLDED CASE
CIRCUIT BREAKERS



For inches / millimeters conversion, see Application Data section.

① CQD breakers are rated 14,000 KAIC at 480/277V.
② Type CQD6—CSA only.

③ 3-pole only.
④ Applicable for 15-30A breakers only.

Molded Case Circuit Breakers

Thermal-Magnetic Trip Breakers

Page				General Purpose Breakers											
				HGG	LGG	ED2	ED4	ED6	HED4	HHED6	CED6				
				7-43	7-43	7-45	7-45	7-45	7-46	7-46	7-46				
Poles				1, 2, 3	1, 2, 3	1, 2, 3	1, 2, 3	1 ^④ , 2, 3	1, 2, 3	2, 3	2, 3				
Amperes, Continuous				15-125	15-125	15-100	15-125	15-125 ^⑦	15-125	15-50	15-125				
Volts 50/60HZ				1-Pole	347	347	120	277	347	277	—	—			
				2-Pole	600/347	600/347	240	480	600	480	600	600	600		
				3-Pole											
Interrupt Rating Symmetrical RMS Amperes				UL	120V	—	—	10,000	—	—	100,000	—	—		
					240V	85,000	100,000	10,000	65,000	65,000	100,000 ^⑤	100,000	200,000		
					277V	—	—	—	22,000 ^①	—	65,000 ^②	—	—		
					347V	—	—	—	—	30,000	—	—	—		
					480V	35,000	65,000	—	18,000	25,000	42,000	65,000	200,000		
					600V	22,000 ^⑥	25,000 ^⑥	—	—	18,000	—	18,000	100,000		
					IEC 947-2 50/60HZ	220/240V	lcu	—	—	—	—	65,000 ^③	—	—	—
							lcs	—	—	—	—	17,000 ^③	—	—	—
						380/415V	lcu	—	—	—	—	35,000 ^③	—	—	—
							lcs	—	—	—	—	9000 ^③	—	—	—
500V	lcu	—	—	—	—	18,000 ^③	—	—	—						
	lcs	—	—	—	—	5000 ^③	—	—	—						
DC				2-Pole, 250V DC Interrupting Ratings	35,000	42,000	5,000	30,000	30,000	30,000	—	30,000			
				3-Pole, 500V DC Interrupting Ratings ^⑧	—	—	—	—	18,000	—	—	—	50,000		
Dimensions in inches				Height	5.40	5.40	6.34	6.34	6.34	6.34	6.58	9.26			
				Width	1-Pole	1.00	1.00	1.00	1.00	1.00	1.00	—	—		
					2-Pole	2.00	2.00	2.00	2.00	2.00	2.00	2.00	2.00		
					3-Pole	3.00	3.00	3.00	3.00	3.00	3.00	3.00	3.00		
					4-Pole	4.00	4.00	—	—	—	—	—	—		
Depth	2.90	2.90	4.00	4.00	4.00	4.00	4.00	4.00	4.00						
Overcurrent Devices				Thermal and Fixed Magnetic Trip	✓	✓	✓	✓	✓	✓	✓				
				Thermal and Adjustable Magnetic Trip	—	—	—	—	—	—	—	—			
				Adjustable Magnetic Trip only	—	—	—	—	✓	—	—	✓			
				Motor Circuit Protector	—	—	—	—	—	—	—	—			
				Molded Case Switch	—	—	✓	✓	✓	—	—	✓			
Accessories & Modifications				Undervoltage Trip	—	—	✓	✓	✓	✓	✓	✓			
				Shunt Trip	✓	✓	✓	✓	✓	✓	✓	✓			
				Auxiliary Switch	✓	✓	✓	✓	✓	✓	✓	✓			
				Alarm Switch	✓	✓	✓	✓	✓	✓	✓	✓			
				Mechanical Interlock	—	—	—	—	—	—	—	—			
				Rear Connection Studs	—	—	✓	✓	✓	✓	✓	✓			
				Electric Motor Operator	—	—	✓	✓	✓	✓	✓	✓			
				Plug-In Mounting Assembly (3 Pole Only)	—	—	✓	✓	✓	✓	✓	✓			
Individual Enclosures				Fungus Proofing (ref. page 7-90)	✓	✓	✓	✓	✓	✓	✓				
				Type 1 — Indoor Surface	✓	✓	✓	✓	✓	✓	✓	✓			
				Type 1 — Indoor, Flush	✓	✓	✓	✓	✓	✓	✓	✓			
				Type 3R — Outdoor-Rainproof	✓	✓	✓	✓	✓	✓	✓	✓			
				Type 7 — Flammable Gas Atmosphere	—	—	✓	✓	✓	✓	✓	—			
				Type 9 — Combustion Dusttight	—	—	✓	✓	✓	✓	✓	—			
				Type 5, 12 — Lint, Fine Dust, Oils, Coolants	✓	✓	✓	✓	✓	✓	✓	✓			
Type 12K — Semi-Dusttight	—	—	✓	✓	✓	✓	✓	✓							

7 MOLDED CASE CIRCUIT BREAKERS

For inches / millimeters conversion, see Application Data section.

- ① 1-pole only.
- ② 35-100A: 25,000 AIR at 277V AC/15-30A; 65,000 AIR at 277V AC.
- ③ For DC UPS system application.
- ④ Single pole ED6 (15-30A) 30kA, (35-100A) 18 kA. CSA Only.
- ⑤ Single pole HED4, 15-30A: 65,000 AIR at 240V AC; single pole HED4, 35-100A: 25,000 AIR at 240V AC.
- ⑥ HGG and LGG breakers are rated at 600/347V.
- ⑦ ED6, 2-pole available 15-125 amps only.
- ⑧ Rating applicable only to 3-pole breakers

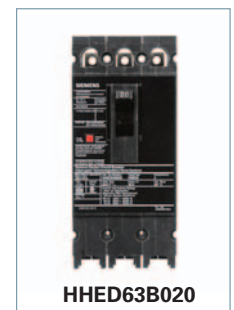
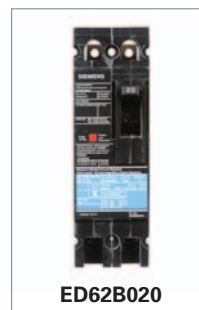

Molded Case Circuit Breakers

Thermal-Magnetic Trip Breakers

Page		General Purpose Breakers												
		FD6A, FXD6A	HFD6, HFXD6	HHFD6, HHFXD6	CFD6	JXD2-A	JD6-A, JXD6-A	HJD6-A, HJXD6-A	HHJD6-A, HHJXD6-A	CJD6-A				
Ratings	AC	Poles		2, 3	2, 3	2, 3	3	2, 3	2, 3	2, 3	2, 3	3		
		Amperes, Continuous		70-250	70-250	70-250	70-250	200-400	200-400	200-400	200-400	200-400		
		Volts 50/60HZ		2-Pole 3-Pole	600	600	600	600	240	600	600	600	600	
		Interrupt Rating Symmetrical RMS Amperes	UL	240V	65,000	100,000	200,000	200,000	65,000	65,000	100,000	200,000	200,000	
				480V	35,000	65,000	100,000	200,000	—	35,000	65,000	100,000	150,000	
				600V	22,000	25,000	25,000	100,000	—	25,000	35,000	50,000	100,000	
			IEC 947-2 50/60HZ ^①	220/ 240V	lcu	65,000	100,000	—	—	—	65,000	100,000	—	—
				380/ 415V	lcs	33,000	50,000	—	—	—	33,000	50,000	—	—
					lcs	35,000	65,000	—	—	—	40,000	65,000	—	—
		500V	lcu	—	—	—	—	—	—	—	—	—	—	
	lcs		—	—	—	—	—	—	—	—	—	—		
	DC	2-Pole 250V DC Interrupting Ratings		30,000	30,000	—	50,000	30,000	30,000	30,000	—	—		
3-Pole, 500V DC Interrupting Ratings ^②		18,000	25,000	—	50,000	—	25,000	35,000	—	50,000				
Dimensions in inches	Height		9.50	9.50	14.12	14.12	11.00	11.00	11.00	11.00	17.86			
	Width		2, 3-Pole	4.50	4.50	4.50	4.50	7.50	7.50	7.50	7.50			
	Depth			4.00	4.00	4.00	4.00	4.00	4.00	4.00	4.00			
Overcurrent Devices	Thermal and Fixed Magnetic Trip		—	—	—	—	—	—	—	—	—			
	Thermal and Adjustable Magnetic Trip		✓	✓	✓	✓	✓	✓	✓	✓	✓			
	Adjustable Magnetic Trip Only Motor Circuit Protector		✓	—	—	✓	—	—	✓	✓	—			
	Molded Case Switch		✓	—	—	✓	✓	✓	—	—	✓			
Accessories & Modifications	Undervoltage Trip		✓	✓	✓	✓	✓	✓	✓	✓	✓			
	Shunt Trip		✓	✓	✓	✓	✓	✓	✓	✓	✓			
	Auxiliary Switch		✓	✓	✓	✓	✓	✓	✓	✓	✓			
	Alarm Switch		✓	✓	✓	✓	✓	✓	✓	✓	✓			
	Mechanical Interlock		✓	✓	✓	✓	✓	✓	✓	✓	✓			
	Rear Connection Studs		✓	✓	✓	✓	✓	✓	✓	✓	✓			
	Electric Motor Operator		✓	✓	✓	✓	✓	✓	✓	✓	✓			
	Plug-In Mounting Assembly		✓	✓	✓	✓	✓	✓	✓	✓	✓			
Fungus Proofing (ref. page 7-90)		✓	✓	✓	✓	—	✓	✓	✓	✓				
Individual Enclosures	Type 1 — Indoor Surface		✓	✓	✓	✓	✓	✓	✓	✓	✓			
	Type 1 — Indoor, Flush		—	✓	—	✓	—	—	—	—	—			
	Type 3R — Outdoor-Rainproof		✓	✓	✓	✓	✓	✓	✓	✓	—			
	Type 7 — Flammable Gas Atmosphere		✓	✓	✓	—	✓	✓	✓	✓	—			
	Type 9 — Combustion Dusttight		✓	✓	✓	—	✓	✓	✓	✓	—			
	Type 5, 12 — Lint, Fine Dust, Oils, Coolants		✓	✓	✓	✓	✓	✓	✓	✓	✓			
Type 12K — Semi-Dusttight		✓	✓	✓	✓	—	✓	✓	✓	—				

For inches / millimeters conversion, see Application Data section.

① Only applicable to interchangeable trip unit types: FXD6A, HFXD6A, JXD6-A, HJXD6-A

② For DC UPS application.

Molded Case Circuit Breakers

Thermal-Magnetic Trip Breakers

				General Purpose Breakers										
				LD6, LXD6	HLD6, HLXD6	HHL6, HHLXD6	CLD6-A	LMD6, LMXD6	HLMD6, HLMXD6	MD6, MXD6	HMD6, HMXD6	CMD6		
Page				7-55	7-56	7-56	7-56	7-59	7-60	7-62	7-63	7-63		
Ratings	AC	Poles		2, 3	2, 3	2, 3	3	2, 3	2, 3	2, 3	2, 3	3		
		Amperes, Continuous		250-600	250-600	250-600	450-600	500-800	500-800	500-800	500-800	400-800		
		Volts 50/60 HZ		600	600	600	600	600	600	600	600	600	600	
														2-Pole
		Interrupt Rating Symmetrical RMS Amperes		UL	240V	65,000	100,000	200,000	200,000	65,000	100,000	65,000	100,000	200,000
					480V	35,000	65,000	100,000	150,000	50,000	65,000	50,000	65,000	100,000
					600V	25,000	35,000	50,000	100,000	25,000	50,000	25,000	50,000	65,000
				IEC 947-2 50/60HZ ^①	220/240V	lcu	65,000	100,000	—	—	—	—	65,000	100,000
		lcs	33,000			50,000	—	—	—	—	33,000	50,000	—	
		380/415V	lcu		40,000	65,000	—	—	—	—	40,000	65,000	—	
	lcs		20,000		33,000	—	—	—	—	20,000	33,000	—		
	DC	2-Pole 250V DC Interrupting Ratings		30,000	30,000	—	—	30,000	30,000	30,000	30,000	30,000		
		3-Pole, 500V DC Interrupting Ratings ^②		35,000	—	—	50,000	25,000	50,000	25,000	50,000	50,000		
		Height		11.00	11.00	11.00	17.86	16.00	16.00	16.00	16.00	16.00		
Width		7.50	7.50	7.50	7.50	7.50	7.50	9.00	9.00	9.00				
Depth		4.00	4.00	4.00	4.00	4.59	4.59	6.19	6.19	6.19				
Overcurrent Devices	Thermal and Adjustable Magnetic Trip		✓	✓	✓	✓	✓	✓	✓	✓	✓			
	Adjustable Magnetic Trip Only Motor Circuit Protector		✓	—	—	✓	✓	✓	—	—	✓			
	Molded Case Switch		✓	—	—	✓	✓	—	✓	—	✓			
Accessories & Modifications	Undervoltage Trip		✓	✓	✓	✓	✓	✓	✓	✓	✓			
	Shunt Trip		✓	✓	✓	✓	✓	✓	✓	✓	✓			
	Auxiliary Switch		✓	✓	✓	✓	✓	✓	✓	✓	✓			
	Alarm Switch		✓	✓	✓	✓	✓	✓	✓	✓	✓			
	Mechanical Interlock		✓	✓	✓	✓	✓	✓	✓	✓	✓			
	Rear Connection Studs		✓	✓	✓	✓	✓	✓	✓	✓	✓			
	Electric Motor Operator		✓	✓	✓	✓	✓	✓	✓	✓	✓			
	Plug-In Mounting Assembly		✓	✓	✓	✓	—	—	✓	✓	✓			
Fungus Proofing (ref. page 7-90)		✓	✓	✓	✓	✓	✓	✓	✓	✓				
Individual Enclosures	Type 1 — Indoor Surface		✓	✓	✓	✓	✓	✓	✓	✓	✓			
	Type 1 — Indoor, Flush		✓	—	—	—	—	—	—	—	—			
	Type 3R — Outdoor-Rainproof		✓	✓	✓	—	✓	✓	✓	✓	✓			
	Type 5, 12 — Lint, Fine Dust, Oils, Coolants		✓	✓	✓	—	✓	✓	✓	✓	✓			
	Type 7 — Flammable Gas Atmosphere		✓	✓	✓	—	—	—	—	—	—			
	Type 9 — Combustion Dusttight		✓	✓	✓	✓	—	—	—	—	—			
Type 12K — Semi-Dusttight		✓	✓	✓	—	✓	✓	✓	✓	✓				

For inches / millimeters conversion, see Application Data section.

① Only applicable to interchangeable trip unit types:
LXD6, HLXD6, MXD6, HMXD6
② For DC UPS application.

Molded Case Circuit Breakers

Reference Guide

Selection/Application

Thermal-Magnetic Trip Breakers

Page		General Purpose Breakers								
		ND6, NXD6	HND6, HNXD6	CND6	PD6 ^② , PXD6 ^②	HPD6 ^③ , HPXD6 ^③	CPD6 ^③			
Ratings	AC	Poles	2, 3	2, 3	3	3	3	3		
		Amperes, Continuous	800-1200	800-1200	800-1200	1200-1600	1200-1600	1200-1600		
		Volts 50/60 HZ	3-Pole	600	600	600	600	600	600	
		Interrupt Rating Symmetrical RMS Amperes	UL	240V	65,000	100,000	200,000	65,000	100,000	200,000
				480V	50,000	65,000	100,000	50,000	65,000	100,000
				600V	25,000	50,000	65,000	25,000	50,000	65,000
			IEC 947-2 50/60HZ ^⑤	220/240V	lcu	65,000	100,000	—	—	—
					lcs	33,000	50,000	—	—	—
				380/415V	lcu	40,000	65,000	—	—	—
		lcs	20,000		33,000	—	—	—		
	500V	lcu	—	—	—	—	—			
		lcs	—	—	—	—	—			
	DC	2-Pole 250V DC Interrupting Ratings	30,000	30,000	30,000	30,000	30,000	30,000		
3-Pole, 500V DC Interrupting Ratings ^⑥		25,000	50,000	50,000	25,000	50,000	50,000			
Dimensions in inches	Circuit breakers require Connect-all mounting block. Dimensions shown are for circuit breaker only.		Height	16.00	16.00	16.00	16.0	16.00	16.00	
			Width	9.00	9.00	9.00	9.00	9.00	9.00	
			Depth	6.19	6.19	6.19	6.19	6.19	6.19	
Overcurrent Devices	Thermal and Adjustable Magnetic Trip		✓	✓	✓	✓	✓	✓		
	Adjustable Magnetic Trip Only		—	—	—	—	—	—		
	Motor Circuit Protector		—	—	—	—	—	—		
Accessories & Modifications	Molded Case Switch		✓	—	✓	✓	—	—		
	Undervoltage Trip		✓	✓	✓	✓	✓	✓		
	Shunt Trip		✓	✓	✓	✓	✓	✓		
	Auxiliary Switch		✓	✓	✓	✓	✓	✓		
	Alarm Switch		✓	✓	✓	✓	✓	✓		
	Mechanical Interlock		✓	✓	✓	✓	✓	✓		
	Rear Connections Studs		✓	✓	✓	—	—	—		
	Electric Motor Operator		✓	✓	✓	✓	✓	✓		
	Plug-in Mounting Assembly		✓	✓	✓	—	—	—		
	Fungus Proofing (ref. page 7-90)		✓	✓	✓	✓	✓	✓		
Mounting Block (required)		—	—	—	✓	✓	✓			
Individual Enclosures	Type 1 — Indoor Surface		✓	✓	✓	✓	✓	✓		
	Type 1 — Indoor, Flush		—	—	—	—	—	—		
	Type 3R — Outdoor-Rainproof		✓	✓	✓	—	—	—		
	Type 7 — Flammable Gas Atmosphere		✓	✓	✓	—	—	—		
	Type 9 — Combustion Dusttight		—	—	—	—	—	—		
	Type 5, 12 — Lint, Fine Dust, Oils, Coolants		—	—	—	—	—	—		
	Type 12K — Semi-Dusttight		✓	✓	✓	—	—	—		

For inches / millimeters conversion, see Application Data section.

- ① For DC UPS application.
- ② 2-pole design.
- ③ 3-pole design.

- ④ Requires Connect-all mounting assembly. Dimensions shown are for circuit breaker only.

- ⑤ Only applicable to interchangeable trip unit types: NXD6, HNXD6

Molded Case Circuit Breakers

Thermal-Magnetic Trip Breakers & Electronic Trip Breakers

				General Purpose Breakers		Solid State Trip Circuit Breakers							
				RD6 [Ⓞ] RXD6 [Ⓞ]	HRD6 [Ⓞ] HRXD6 [Ⓞ]	SJD6	SHJD6	SCJD6	SLD6	SHLD6	SCLD6		
Page				7-73	7-73	7-53	7-53	7-53	7-57	7-57	7-57		
Ratings	AC	Poles		3	3	3	3	3	3	3	3		
		Amperes, Continuous		1600-2000	1600-2000	200-400	200-400	200-400	300-600	300-600	300-600		
		Volts 50/60 HZ		3-Pole	600	600	600	600	600	600	600	600	
		Interrupt Rating Symmetrical RMS Amperes	UL	240V	65,000	100,000	65,000	100,000	200,000	65,000	100,000	200,000	
				480V	50,000	65,000	35,000	65,000	150,000	35,000	65,000	150,000	
				600V	25,000	50,000	25,000	35,000	100,000	25,000	35,000	100,000	
			IEC60947-2 50/60HZ	220/240V	lcu	—	—	—	—	—	—	—	—
				380/415V	lcs	—	—	—	—	—	—	—	—
					lcs	—	—	—	—	—	—	—	—
		500V	lcs	—	—	—	—	—	—	—	—	—	
	lcs		—	—	—	—	—	—	—	—	—		
	DC	2-Pole 250V DC Interrupting Ratings		30,000	30,000	—	—	—	—	—	—		
		3-Pole, 500V DC Interrupting Ratings [Ⓞ]		25,000	50,000	—	—	—	—	—	—		
	Dimensions in inches	Height		16.00	16.00	11.00	11.00	17.86	11.0	11.00	17.86		
Width		3-Pole	9.00	9.00	7.50	7.50	7.50	7.50	7.50	7.50			
Depth			6.19	6.19	4.00	4.00	4.00	4.00	4.00	4.00			
Overcurrent Devices	Solid State Trip		—	—	✓	✓	✓	✓	✓	✓			
	Optional DAS / Maintenance Mode		—	—	✓	✓	✓	✓	✓	✓			
	Thermal and Adjustable Magnetic Trip		✓	✓	—	—	—	—	—	—			
	Adjustable Magnetic Trip Only Motor Circuit Protector		—	—	—	—	—	—	—	—			
	Molded Case Switch		✓	—	—	—	—	—	—	—			
Accessories & Modifications	Undervoltage Trip		✓	✓	✓	✓	✓	✓	✓	✓			
	Shunt Trip		✓	✓	✓	✓	✓	✓	✓	✓			
	Auxiliary Switch		✓	✓	✓	✓	✓	✓	✓	✓			
	Alarm Switch		✓	✓	✓	✓	✓	✓	✓	✓			
	Mechanical Interlock		✓	✓	✓	✓	✓	✓	✓	✓			
	Rear Connections Studs		—	—	✓	✓	✓	✓	✓	✓			
	Electric Motor Operator		✓	✓	✓	✓	✓	✓	✓	✓			
	Plug-In Mounting Assembly		—	—	✓	✓	✓	✓	✓	✓			
	Fungus Proofing (ref. page 7-90)		✓	✓	✓	✓	✓	✓	✓	✓			
	Mounting Block (required)		✓	✓	—	—	—	—	—	—			
Individual Enclosures	Type 1 — Indoor Surface		✓	✓	✓	✓	✓	✓	✓	✓			
	Type 1 — Indoor, Flush		—	—	—	—	—	—	—	—			
	Type 3R — Outdoor-Rainproof		—	—	✓	✓	—	✓	✓	—			
	Type 7 — Flammable Gas Atmosphere		—	—	✓	✓	—	✓	✓	—			
	Type 9 — Combustion Dusttight		—	—	✓	✓	—	✓	✓	—			
	Type 5, 12 — Lint, Fine Dust, Oils, Coolants		—	—	✓	✓	✓	✓	✓	✓			
Type 12K — Semi-Dusttight		—	—	✓	✓	✓	✓	✓	✓				

For inches / millimeters conversion, see Application Data section.

[Ⓞ] Requires Connect-all mounting assembly. Dimensions shown are for circuit breaker only.

Molded Case Circuit Breakers

Electronic Trip Breakers

Page		Solid State Trip Circuit Breakers											
		SMD6	SHMD6	SCMD6	SND6	SHND6	SCND6	SPD6 [Ⓞ]	SHPD6 [Ⓞ]				
Ratings	AC	Poles	3	3	3	3	3	3	3				
		Amperes, Continuous	600-800	600-800	600-800	800-1200	800-1200	800-1200	1200-1600	1200-1600			
		Volts 50/60HZ	3-Pole	600	600	600	600	600	600	600			
		Interrupt Rating Symmetrical RMS Amperes	UL	240V	65,000	100,000	200,000	65,000	100,000	200,000	65,000	100,000	
				480V	50,000	65,000	100,000	50,000	65,000	100,000	50,000	65,000	
				600V	25,000	50,000	65,000	25,000	50,000	65,000	25,000	50,000	
			IEC60947-2 50/60HZ	380/415V	lcu	—	—	—	—	—	—	—	—
					lcs	—	—	—	—	—	—	—	—
				690V	lcu	—	—	—	—	—	—	—	—
		lcs	—	—	—	—	—	—	—	—	—		
Dimensions in inches	Height	10.00	16.00	16.00	16.00	16.00	16.00	16.00	16.00				
	Width	9.00	9.00	9.00	9.00	9.00	9.00	9.00	9.00				
	Depth	6.19	6.19	6.19	6.19	6.19	6.19	6.19	6.19				
Overcurrent Devices	Solid State Trip	✓	✓	✓	✓	✓	✓	✓	✓				
	Optional DAS / Maintenance Mode	✓	✓	✓	✓	✓	✓	✓	✓				
Accessories & Modifications	Undervoltage Trip	✓	✓	✓	✓	✓	✓	✓	✓				
	Shunt Trip	✓	✓	✓	✓	✓	✓	✓	✓				
	Auxiliary Switch	✓	✓	✓	✓	✓	✓	✓	✓				
	Alarm Switch	✓	✓	✓	✓	✓	✓	✓	✓				
	Mechanical Interlock	✓	✓	✓	✓	✓	✓	✓	✓				
	Rear Connection Studs	✓	✓	✓	✓	✓	✓	—	—				
	Electric Motor Operator	✓	✓	✓	✓	✓	✓	✓	✓				
	Plug-In Mounting Assembly	✓	✓	✓	✓	✓	✓	—	—				
	Fungus Proofing (ref. page 7-90)	✓	✓	✓	✓	✓	✓	✓	✓				
Individual Enclosures	Type 1 — Indoor Surface	✓	✓	✓	✓	✓	✓	✓	✓				
	Type 1 — Indoor, Flush	—	—	—	—	—	—	—	—				
	Type 3R — Outdoor-Rainproof	✓	✓	✓	✓	✓	✓	—	—				
	Type 7 — Flammable Gas Atmosphere	—	—	—	—	—	—	—	—				
	Type 9 — Combustion Dusttight	—	—	—	—	—	—	—	—				
	Type 5, 12 — Lint, Fine Dust, Oils, Coolants	✓	✓	✓	✓	✓	✓	—	—				
	Type 12K — Semi-Dusttight	✓	✓	✓	✓	✓	✓	—	—				

For inches / millimeters conversion, see Application Data section.

Ⓞ Requires connect-all mounting block assembly. Dimensions shown are for circuit breaker.

Ⓞ Breaker has rating plugs which can be changed within each frame rating.

Molded Case Circuit Breakers

Page	7-107			7-111			7-115						
Breaker Frame Family	DG			FG			JG						
	Continuous Amps			30–150A			40–250A			70–400A			
	Poles			2, 3			2, 3			2, 3			
	Max. Volts AC			600Y/347V			600Y/347V			600V			
Breaker Type	NDGA	HDGA	LDGA	NFGA	HFGA	LFGA	NJGA	HJGA	LJGA				
Ratings	Interrupting Class			N	H	L	N	H	L	N	H	L	
	Interrupting Rating RMS Symmetrical Amperes AC 50/60Hz	UL	240Vac	65	100	200	65	100	200	65	100	200	
			480Vac	35	65	100	35	65	100	35	65	100	
		I _{cu} /I _{cs}	600Vac	18	18	18	18	18	18	18	25	25	25
			220/240Vac	65/65	100/75	200/150	65/65	100/75	200/150	65/65	100/75	200/150	
	DC Interrupting Ratings (UL) ^②		380/415Vac	40/40	70/70	100/75	40/40	70/70	100/75	45/45	70/70	100/75	
			690Vac	12/6	12/6	12/6	12/6	12/6	12/6	12/6	15/8	15/8	
250Vdc (2-Pole)			30	30	30	30	30	30	30	30	30		
500Vdc (3-Pole) ^①		500Vdc (3-Pole) ^①	18	18	18	18	18	30	25	35	35		
		600Vdc (3-Pole) ^③	—	42	—	—	42	—	—	65	—		
Dimensions in Inches	1-Pole			—						—			
	2-Pole			6.9H x 4.1W x 3.4D						11H x 5.5W x 4.2D			
	3-Pole			6.9H x 4.1W x 3.4D						11H x 5.5W x 4.2D			
	4-Pole			—						—			
Trip Unit Information	Thermal-Magnetic			◆			◆			◆			
	Electronic			◆			◆			◆			
	Electronic with LCD			◆			◆			◆			
	Interchangeable Trip Unit			—			—			◆			
	Reverse Feed (w/Non-Interchangeable Trip)			◆			◆			◆			
	Communications Capability ^④			◆			◆			◆			
Specific Application Breakers	Molded Case Switch			◆			◆			◆			
	Motor Circuit Protector			◆			◆			◆			
	100% Rated			◆			◆			◆			
	50°C Calibrated ^⑤			◆			◆			◆			
Accessories & Modifications	Auxiliary Switch			◆			◆			◆			
	Alarm Switch			◆			◆			◆			
	Shunt Trip			◆			◆			◆			
	Undervoltage Release			◆			◆			◆			
	Mechanical Interlocks			◆			◆			◆			
	Electric Motor or Stored Energy Operator			◆			◆			◆			
	Rear Connecting Studs			◆			◆			◆			
	Plug-In Mounting Assy. w/Trip Interlock			◆			◆			◆			
	Draw-Out Assembly			◆			◆			◆			
	Handle Mechanism Options			◆			◆			◆			
Enclosures^⑥	NEMA 1 – Indoor, Surface Mount			◆			◆			◆			
	NEMA 1 – Indoor, Flush Mount			◆			◆			◆			
	NEMA 3R – Outdoor, Rain Proof			◆			◆			◆			
	NEMA 4, 4X – Stainless Steel			◆			◆			◆			
	NEMA 7, 9 – Hazardous Locations			◆			◆			◆			
NEMA 12 – Dust			◆			◆			◆				
	Terminal Shields			◆			◆			◆			
	Distribution Lugs			◆			◆			◆			
	Ground Sensor (Neutral Transformer)			◆			◆			◆			

① 500Vdc nominal, 600Vdc max. for ungrounded DC UPS systems.
 ② DC Interrupting Ratings are not applicable to electronic circuit breakers.
 ③ Communications available via a COMPRO or COMMODO modules using Profibus or Modbus protocols.
 ④ Consult Siemens for availability.
 ⑤ “Non-metallic” NEMA 4X enclosure for NGG breakers.
 ⑥ Special version, see page 7-136.
 GG are not VL family breakers and do not share common VL accessories.
 ⑦ 304 and 316 Stainless Steel

Molded Case Circuit Breakers

Page	7-119			7-123			7-127			7-131					
Breaker Frame Family	LG			MG			NG			PG					
Continuous Amps	150–600A			200–800A			300–1200A			400–1600A					
	2, 3			2, 3			2, 3			3					
	600V			600V			600V			600V					
Breaker Type	NLGB	HLGB	LLGB	NMG	HMG	LMG	NNG	HNG	LNG	NPG	HPG	LPG			
Ratings	Interrupting Class		N	H	L	N	H	L	N	H	L	N	H	L	
	Interrupting Rating RMS Symmetrical Amperes AC 50/60Hz	UL	240Vac	65	100	200	65	100	200	65	100	200	65	100	200
			480Vac	35	65	100	35	65	100	35	65	100	35	65	100
		I _{CU} / I _{CS}	600Vac	18 ^⑥	18	18	25	35	65	25	35	65	25	35	65
			220/240Vac	65/65	100/75	200/150	65/35	100/50	200/150	65/65	100/75	200/100	65/35	100/50	200/100
	DC Interrupting Ratings (UL) ^③		380/415Vac	45/45	70/70	100/75	50/50	70/70	100/75	50/25	70/35	100/50	50/25	70/35	100/50
			690Vac	12/6	15/8	15/8	20/10	30/15	35/17	20/10	30/15	35/17	20/10	30/15	35/15
			250Vdc (2-Pole)	30	30	30	22	25	42	22	25	42	22	25	42
Dimensions in Inches	2-Pole		11H x 5.5W x 4.2D			16H x 7.5W x 4.7D			16H x 9W x 6.2D			—			
	3-Pole		11H x 5.5W x 4.2D			16H x 7.5W x 4.7D			16H x 9W x 6.2D						
Trip Unit Information	Thermal-Magnetic		◆			◆			◆			◆			
	Electronic		◆			◆			◆			◆			
	Electronic with LCD		◆			◆			◆			◆			
	Interchangeable Trip Unit		◆			◆			◆			◆			
	Reverse Feed (w/Non-Interchangeable Trip)		◆			◆			◆			◆			
	Communications Capability ^①		◆			◆			◆			◆			
Specific Application Breakers	Molded Case Switch		◆			◆			◆			◆			
	Motor Circuit Protector		◆			◆			◆			◆			
	100% Rated ^④		◆			◆			◆			◆			
Accessories and Modifications	Auxiliary Switch		◆			◆			◆			◆			
	Alarm Switch		◆			◆			◆			◆			
	Shunt Trip		◆			◆			◆			◆			
	Undervoltage Release		◆			◆			◆			◆			
	Mechanical Interlocks		◆			◆			◆			◆			
	Electric Motor or Stored Energy Operator		◆			◆			◆			◆			
	Rear Connecting Studs		◆			◆			◆			◆			
	Plug-In Mounting Assy. w/Trip Interlock		◆			◆			◆			◆			
	Draw-Out Assembly		◆			◆			◆			◆			
	Terminal Shields		◆			◆			◆			◆			
	Distribution Lugs		◆			◆			◆			◆			
	Ground Sensor (Neutral Transformer)		◆			◆			◆			◆			

① Communications available via COMPRO or COMMOD modules using Profibus or Modbus protocol.
 ② 500Vdc nominal, 600Vdc max. for ungrounded DC UPS systems.
 ③ DC Interrupting Ratings are not applicable to electronic circuit breakers.
 ④ LG frame maximum 500A.
 ⑤ Special version, see page 7-136.
 ⑥ Special 600Vac 25kA version available, see page 7-120.

Circuit Breakers

Arc-Fault and Ground-Fault Breakers

Selection/Wiring Diagrams

Arc-Fault Circuit Interrupters (AFCI)

AFCI's detect arcing faults (an unintentional arcing condition in a circuit) that standard circuit breakers are unable to detect. The device is intended to mitigate the effects of arcing faults by functioning to de-energize the circuit when an arc-fault is detected.

Combination Type AFCI

Detects all three possible types of arc faults: line-to-ground, line-to-neutral, and series.

Breaker Type	Ampere Rating	10,000 A IR Catalog No.	22,000 A IR Catalog No.	65,000 A IR Catalog No.
QAF2/QAFH2/HQAF2 1-Pole 120V AC	15	QA115AFC ①②	QA115AFCH ①	QA115AFCHH ①
	20	QA120AFC ①②	QA120AFCH ①	QA120AFCHH ①
QAF/QAFH 2-Pole 120/240V AC	15	Q215AFC ①②	Q215AFCH ①	—
	20	Q220AFC ①②	Q220AFCH ①	—

Branch-Feeder AFCI

Detects line-to-ground and line-to neutral arcs.

Breaker Type	Ampere Rating	10,000 A IR Catalog No.	22,000 A IR Catalog No.	65,000 A IR Catalog No.
QAF2/QAFH2/HQAF2 1-Pole 120V AC	15	QA115AF ①	QA115AFH ①	QA115AFHH ①
	20	QA120AF ①	QA120AFH ①	QA120AFHH ①

NEW Dual Function AFCI/GFCI

The Dual Function Circuit Breaker combines Combination Type AFCI and GFCI, protecting against both Arc Faults and (5mA) Ground Faults. The device includes the Self Test feature, making it the first in class in electrical safety for homeowners.

Breaker Type	Ampere Rating	10,000 A IR Catalog No.	22,000 A IR Catalog No.	65,000 A IR Catalog No.
QFGA2/QFGAH2/HQFGA2 1-Pole 120V AC	15	Q115DF ①②	Q115DFH ①	Q115DFHH ①
	20	Q120DF ①②	Q120DFH ①	Q120DFHH ①

Ground-Fault Circuit Interrupters (GFCI)

Provides Class A (5mA) ground fault protection. Intended for personnel protection. Includes Self Test as an added safety feature.

Breaker Type	Amp Rating	10,000 A IR Catalog No.	22,000 A IR Catalog No.	65,000 A IR Catalog No.
QPF2/QPHF2/HQPF2 1-Pole 120V AC Plug-in	15	QF115A ②③	QF115AH ①	QF115AHH ①
	20	QF120A ②③	QF120AH ①	QF120AHH ①
	30	QF130A ①	QF130AH ①	QF130AHH ①
QPF/QPHF 2-Pole 120/240V AC Plug-in	15	QF215A	QF215AH	—
	20	QF220A	QF220AH	—
	30	QF230A	QF230AH	—
	40	QF240A	QF240AH	—
	50	QF250A	QF250AH	—
	60	QF260A	QF260AH	—

Ground Fault Equipment Protection (30mA)

Provides protection of equipment from damaging line-to-ground faults currents. De-energizes the circuit for all ungrounded conductors of the circuit.

Breaker Type	Ampere Rating	10,000 A IR Catalog No.	22,000 A IR Catalog No.	65,000 A IR Catalog No.
QE/QEH 1-Pole 120V AC Plug-in	15	QE115	QE115H	—
	20	QE120	QE120H	—
	30	QE130	QE130H	—
QE/QEH 2-Pole 120/240V AC Plug-in	15	QE215	QE215H	—
	20	QE220	QE220H	—
	30	QE230	QE230H	—
	40	QE240	QE240H	—
	50	QE250	QE250H	—
	60	QE260	QE260H	—

QAF2/QPF/QE/QPF2 Accessories

Description	Catalog Number ^①
Padlocking Device 1-Pole	ECPLD1
Padlocking Device 2-Pole	ECPLD2
Handle Block	ECBX231M

■ Built to order. Allow 8 - 10 weeks for delivery.

① UL Listed as SWD (Switching Duty) Rated, suitable for 120V AC Fluorescent Lighting.

② Add WG to the part number for the WireGuide version, see page 1-4 for full selection.

• UL Listed

• HACR Rated



1-Pole Combination Type AFCI



2-Pole Combination Type AFCI



1-Pole Branch Feeder AFCI



1-Pole Dual Function AFCI/GFCI



1-Pole GFCI



2-Pole GFCI



1-Pole Equipment Protection



2-Pole Equipment Protection

Wiring Diagrams

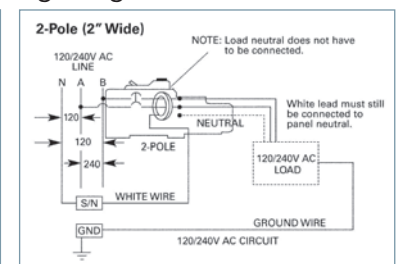
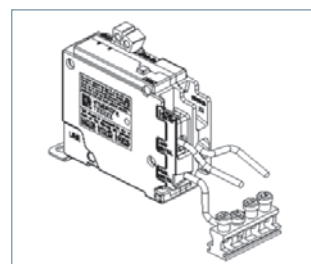

7
MOLDED CASE
CIRCUIT BREAKERS

Circuit Breakers

Type QP with INSTA-WIRE

Selection

Continuous Current Rating @ 40° C	Type QP ^①	Type QPH	Type HQP
	10,000A IR	22,000A IR	65,000A IR
	Catalog Number	Catalog Number	Catalog Number

1-Pole Plug-In (120V AC)^⑤

Rating	Type QP ^①	Type QPH	Type HQP
10	Q110 ^②	—	—
15	Q115 ^③	Q115H ^④	Q115HH ^⑥
20	Q120 ^③	Q120H ^④	Q120HH ^⑥
25	Q125	Q125H■	Q125HH■
30	Q130	Q130H	Q130HH■
35	Q135■	Q135H■	Q135HH■
40	Q140	Q140H	Q140HH■
45	Q145■	Q145H■	Q145HH■
50	Q150	Q150H	Q150HH■
60	Q160	Q160H■	Q160HH■
70	Q170	Q170H■	Q170HH■



2-Pole Plug-In (Common-Trip 120/240V AC)^⑥

Rating	Type QP ^①	Type QPH	Type HQP
10	Q210 ^②	—	—
15	Q215	Q215H	Q215HH
20	Q220	Q220H	Q220HH
25	Q225	Q225H■	Q225HH■
30	Q230	Q230H	Q230HH
35	Q235	Q235H■	Q235HH■
40	Q240	Q240H	Q240HH■
45	Q245	Q245H■	Q245HH■
50	Q250	Q250H	Q250HH
60	Q260	Q260H	Q260HH
70	Q270	Q270H	Q270HH
80	Q280	Q280H■	Q280HH■
90	Q290	Q290H	Q290HH■
100	Q2100	Q2100H	Q2100HH
110	Q2110	Q2110H	Q2110HH■
125	Q2125	Q2125H	Q2125HH



2-Pole Plug-In (Common-Trip 240V AC)^{④⑥}

Rating	Type QP ^①	Type QPH	Type HQP
15	Q215R	—	—
20	Q220R	—	—
30	Q230R	—	—
40	Q240R	—	—
50	Q250R	—	—

3-Pole Plug-In (Common-Trip 240V AC)^⑦

Rating	Type QP ^①	Type QPH	Type HQP
15	Q315	Q315H	Q315HH■
20	Q320	Q320H	Q320HH
25	Q325	Q325H■	Q325HH■
30	Q330	Q330H	Q330HH
35	Q335	Q335H■	Q335HH■
40	Q340	Q340H	Q340HH
45	Q345	Q345H■	Q345HH■
50	Q350	Q350H	Q350HH
60	Q360	Q360H	Q360HH
70	Q370	Q370H	Q370HH■
80	Q380	Q380H	Q380HH■
90	Q390	Q390H	Q390HH■
100	Q3100	Q3100H	Q3100HH



QP / QPH / HQP Internal Accessories

Control Voltage AC	Catalog Number	Field/Factory Installed
120V Shunt Trip	add suffix ...00S01■	Factory
24V Shunt Trip	add suffix ...00S07■	Factory
120V Auxiliary Switch	add suffix ...01■ ^②	Factory

Modifications

Description	Catalog Number
400 Hz Calibration	add suffix ...Y ^⑧
Marine 50°C Ambient Calibration	add suffix ...M
Fungus Proofing	add suffix ...F

For external accessories, please refer to page 7-92

■ Built to order. Allow 2-3 weeks for delivery.

① UL Listed for use with 60/75° wire through 40 amps, UL listed for use with 75° wire only for 50 amps and above, HACR rated.

② 1A and 1B contacts.

③ UL Listed for frequent switching applications (SWD), 120V AC Fluorescent Lighting.

④ UL Listed for use on 3-phase grounded "B" systems — 10,000 for this application.

⑤ Shipped 12 per sleeve.

⑥ Shipped 6 per sleeve.

⑦ Shipped 4 per sleeve.

⑧ UL Listed 5 KA IR.

⑨ Type QP1, UL listed for 16 AWG conductors and multiple wires.

Circuit Breakers

Duplex, Triplex and Quadplex Plug-In Breakers

Selection

Duplex Circuit Breakers

Breaker Type	Ampere Rating	Catalog Number	Catalog Number
QT 1-Pole 10K AIC 120V AC	15-15	Q1515	Q1515NC ^①
	15-20	Q1520	Q1520NC ^①
	20-20	Q2020	Q2020NC ^①
	20-30	Q2030	—
	30-15■	Q3015	—
	30-20	Q3020	—
	30-30	Q3030	Q3030NC ^①
SHIPPING: 12 per carton, (Wt. 4.8 lbs.)			

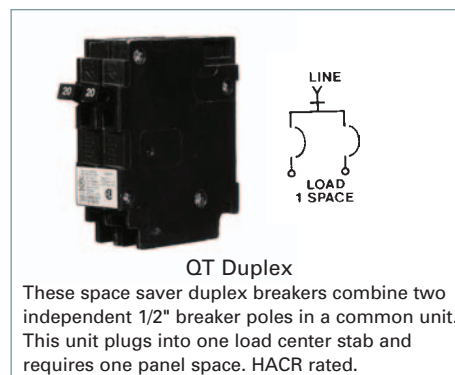

Triplex Circuit Breakers

Breaker Type	Ampere Rating		Catalog Number	
	Single Pole	Common-Trip 2-Pole		
QT 2-Pole 10K AIC 120/240V AC Inner Poles Common Trip	15	15	Q21515CT	
	15	20	Q21520CT	
	15	25	Q21525CT ■	
	15	30	Q21530CT	
	15	35	Q21535CT ■	
	15	40	Q21540CT	
	15	45	Q21545CT ■	
	15	50	Q21550CT	
	20	20	Q22020CT	
	20	25	Q22025CT ■	
	20	30	Q22030CT	
	20	35	Q22035CT ■	
	20	40	Q22040CT	
	20	45	Q22045CT ■	
	20	50	Q22050CT	
	30	30	Q23030CT	
	SHIPPING: 6 per carton, (Wt. 4.9 lbs.)			

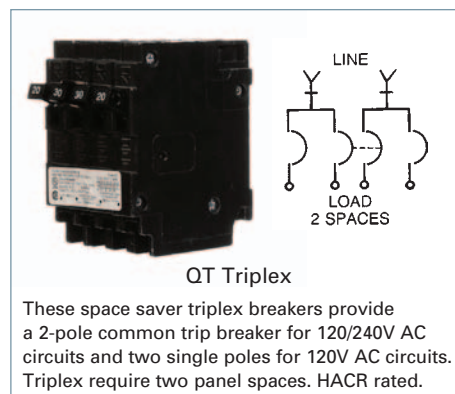

Quadplex Circuit Breakers

Breaker Type	Ampere Rating		Catalog Number
	Common-Trip 2-Pole Outside	Common-Trip 2-Pole Inside	
QT 2-Pole 10K AIC 120/240V AC Inner and Outer 2 Poles Common Trip	15	15	Q21515CT2
	15	30	Q21530CT2
	20	20	Q22020CT2
	20	50	Q22050CT2
	30	20	Q23020CT2
	30	25	Q23025CT2
	30	30	Q23030CT2
	30	50	Q23050CT2
	40	20	Q24020CT2
	40	30	Q24030CT2
	40	40	Q24040CT2
	SHIPPING: 6 per carton, (Wt. 4.8 lbs.)		

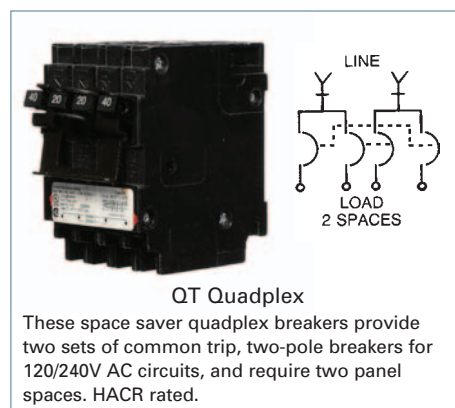

For external accessories, please refer to page 7-92

For inches / millimeters conversion, see Application Data section.

■ Built to order. Allow 2-3 weeks for delivery.

① Non-CTL. For replacement use only in panels manufactured before 1968

Circuit Breakers

Special Application Breakers

Selection

HID Lighting

For high-intensity discharge lamp loads having in-rush currents above the instantaneous trip setting of a standard breaker.

Breaker Type	Wiring Diagram	Complete Breaker UL Unenclosed	
		Ampere Rating	Catalog Number
QP 1-Pole 120V AC	Figure 1	15	Q115HID [Ⓞ] ■
		20	Q120HID [Ⓞ]
		30	Q130HID
QP 2-Pole 120/240V AC	Figure 2	15	Q215HID
		20	Q220HID■
		30	Q230HID■

Molded Case Switch

For applications that do not require overcurrent protection.

QP 1-Pole 120V AC	Figure 1	100	Q1100S
QP 2-Pole 120/240V AC	Figure 2	30	Q230S
		50	Q250S
		60	Q260S
		125	Q2125S

No-Noise

For applications that require a reduction in the 60-cycle hum of a standard breaker.

QP 2-Pole 120/240V AC	Figure 2	50	Q250NN■
		60	Q260NN

Switching Neutrals

Used where all conductors are required to be disconnected. Neutral pole of the circuit breaker does not connect to load center bus. One side is wired to neutral and the other side to the device.

QG 2-Wire Common Trip 120V AC	Figure 3	15	QG215
		20	QG220
QG 3-Wire Common Trip 120/240V AC	Figure 4	20	QG320



Switching Neutral

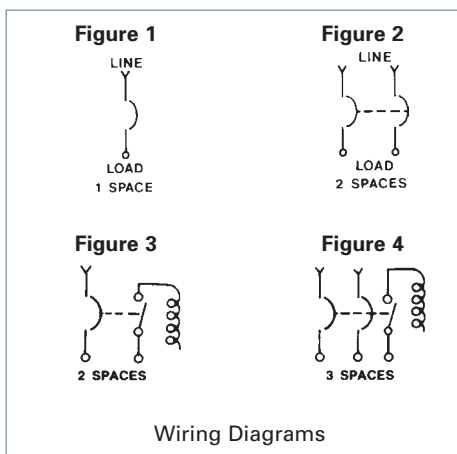

Wiring Diagrams

■ Built to order. Allow 2-3 weeks for delivery.
Note: All circuit breakers on this page are 10K AIC

Ⓞ UL Listed as SWD (Switching Duty) Rated, suitable for 120V AC Fluorescent Lighting.

Circuit Breakers

3/4 Inch Plug-In Breakers

Selection

Features

- 3/4" format
- HACR Rated
- UL Classified for use in certain Square D load centers

Type QD Circuit Breakers

The Type QD circuit breaker line is available in 1-pole and 2-pole common trip versions listed on this page.

The circuit breakers are UL Classified and UL Listed.

All QD breakers are supplied with load side connectors suitable for 60/75°C wire and are calibrated for 40°C maximum ambient applications.

UL Classified

Siemens Type QD circuit breakers are UL Classified for use in specific Square D load centers in place of Square D Type QO® circuit breakers. A Panelboard Compatibility List packaged with each QD breaker shows which type QD circuit breakers are acceptable for use in Square D load centers.

The interrupting rating on these circuit breakers is 10,000A IR maximum and they are **not** series rated with Square D circuit breakers or equipment. This UL Classification allows a Siemens Type QD circuit breaker to be used in place of a Square D Type QO circuit breaker in those load centers that are specifically shown on the Panelboard Compatibility list. For additional information, contact your local Siemens sales engineer.



Continuous Current Rating @ 40°C	1-Pole	2-Pole
	120V	120/240V Common Trip
	Catalog Number	Catalog Number
15	D115 ^①	D215
20	D120 ^①	D220
30	D130	D230
40	D140	D240
50	D150	D250
60	D160	D260

Shipping Weights

Number of Poles	Number Per Carton	Shipping Weight (lbs.)
1	16	3.8
2	8	4.2

Panelboard Compatibility List

Listed Panelboards—Square D—Catalog Numbers

QO2L30F/S	QO12M100/RB	QO120-30M150/RB	QO130-40M200
QO2-4L70F/S	QO16-20M100/RB	QO124L150G	QO130M200/RB
QO2-4L70TS	QO16M100/RB	QO124M150	QO130-40L200G/RB
QO2-4L70RB	QO20M100/RB	QO130L150G/RB	QO140M200/RB
QO6-12L100F/S	QO112L125G/RB	QO130M150/RB	QO16L200/RB
QO6-12L100DF/S	QO112-24L125G/RB	QO16L150/RB	QO16M200/RB
QO6-12L100TF/S	QO112-24L125GWGC	QO16M150/RB	QO18-16M200FTRB
QO6-12L100DTF/S	QO116L125G	QO16-30L150/RB	QO20-40L200/RB
QO6-12L100RB	QO116-24L125G/RB	QO18-16M150FTRB	QO20-40M200TF/S
QO8-16L100F/S	QO12-24L125/RB	QO20-30M150/RB	QO20-40M200/RB
QO8-16L100DF/S	QO120-24L125G	QO20-30M150TF/S	QO24L200/RB
QO8-16L100TF/S	QO120-24L125GWGC	QO20-30L150	QO24M200/RB
QO8-16L100DTF/S	QO120L125G	QO24L150/RB	QO30L200/RB
QO8-16L100RB	QO124L125G/RB	QO24M150/RB	QO30M200/RB
QO112M100/RB	QO124M125/RB	QO30L150/RB	QO30-40L200/RB
QO116M100/RB	QO16L125/RB	QO30M150/RB	QO30-40M200/RB
QO120M100/RB	QO16-12M125FTRB	QO8-16M200FT/RB	QO40M200/RB
QO124M100	QO16-24L125/RB	QO112L200G/RB	QO140M225
QO12L100DF/S	QO20L125/RB	QO120-40M200/RB	QO142L225G/RB
QO12L100RB	QO20-24L125/RB	QO120-40M200TC	
QO12-20M100/RB	QO24L125/RB	QO124M200	
QO12-20M100TF/S	QO120-30L150G	QO130L200G/RB	

For inches / millimeters conversion, see Application Data section.

① UL Listed for frequent switching applications (SWD). 120V AC Fluorescent Lighting. One or two load conductors.

Circuit Breakers

Main and Branch Circuit Breakers^a

Selection

Breaker Type	Ampere Rating	Catalog Number	Catalog Number	UL Interrupting Ratings (kA)
QN 2-Pole 120/240V AC	150	QN2150	QN2150R ^②	10
	175	QN2175■	QN2175R ^② ■	10
	200	QN2200	QN2200R ^②	10
QNH 2-Pole 120/240V AC	150	QN2150H	QN2150RH ^②	22
	175	QN2175H■	QN2175RH ^② ■	22
	200	QN2200H	QN2200RH ^②	22
HQN 2-Pole 120/240V AC	150	HQN2150	HQN2150R ^②	65
	175	HQN2175■	—	65
	200	HQN2200	HQN2200R ^②	65

Requires 4 panel spaces, 2 adjacent and 2 opposite. **SHIPPING:** 1 per carton (Wt. 3 lbs.)



QNR^③

QN^③

Main Breaker Kits

For use in Ultimate Load Centers ^④			For use in EQIII Load Centers			
UL Type	Ampere Rating	Catalog Number	UL Type	Ampere Rating	Catalog Number	UL Interrupting Ratings (kA)
EQ8681	100	MBK100A	EQ9675	100	MBK100	22
EQ8682	125	MBK125A	EQ9677	125	MBK125	22
EQ8693	150	MBK150A	EQ9683	150	MBK150	22
—	—	—	EQ9684	175	MBK175■	22
EQ8695	200	MBK200A	EQ9685	200	MBK200	22
EQ8696	225	MBK225A	EQ9686	225	MBK225	22



EQ9675

Breaker Type	Ampere Rating	Catalog Number	UL Interrupting Ratings (kA)
QPJ ^⑤ 3-Pole 240V AC	125	QPJ3125	10
	150	QPJ3150	10
	200	QPJ3200	10

Requires 6 spaces due to cross over design. Fits only EQIII 125-400A 3-phase load centers

SHIPPING: 5 per carton (Wt. 17 lbs.)

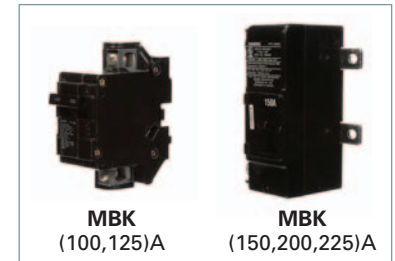

MBK
(100,125)A

MBK
(150,200,225)A

Breaker Type	Ampere Rating	Catalog Number	UL Interrupting Breaker Ratings (kA) Volts AC 120/240
QPP 2-Pole 120/240V AC	125	Q2125B	10
	150	Q2150B	10
	175	Q2175B■	10
	200	Q2200B	10
	225	Q2225B	10
QPPH 2-Pole 120/240V AC	125	Q2125BH	22
	150	Q2150BH	22
	175	Q2175BH■	22
	200	Q2200BH	22
	225	Q2225BH■	22
HQPP 2-Pole 120/240V AC	125	Q2125BHH■	65
	150	Q2150BHH	65
	175	Q2175BHH■	65
	200	Q2200BHH	65
	225	Q2225BHH■	65
HQPPH 2-Pole 120/240V AC	100	HQ2100BH■	100
	125	HQ2125BH■	100
	150	HQ2150BH■	100
	175	HQ2175BH■	100
	200	HQ2200BH■	100
225	HQ2225BH■	100	



QPJ



2-Pole QPP

For inches / millimeters conversion, see Application Data section.

■ Built to order. Allow 2-3 weeks for delivery.

- ① All circuit breakers on this page are common trip.
- ② Reverse handle.
- ③ CSA Listed.
- ④ MBK100A for use in 100 and 125A load centers.
- MBK125A for use in 125A load centers.
- MBK150A for use in 150, 200 and 225A load centers.
- MBK200A for use in 200 and 225A load centers.
- MBK225A for use in 225A load centers.
- MBK175A for use in 200 and 225A load centers.

- ⑤ QNR required for horizontal applications or vertical applications where the lugs are facing up. The QN breaker is required for vertical applications where the lugs are facing down as shown.

Circuit Breakers

Main and Branch Circuit Breakers

QS Breaker^①

PowerMod's core offering of residential Meter Stacks, type WMM, offers the widest product offering & flexibility in the industry. Each meter stack houses the QuickSystem features to maximize productivity and minimize labor costs. To further simplify installation, our 225 Amp meter stacks feature the QS breaker. The QS breaker adds to the Siemens exclusive feature set in our Power Mod product line. Benefits and part numbers include:

- An exclusive side wired design saves wiring space and eliminates difficult "S bends"
- No need for costly filler plates — QS 225 Amp breaker takes the same space as standard 100 Amp QPs
- Single right hand bend wiring - saves time and wire
- Provides 100K AIC flexibility from 100 up to 225 Amps
- 10K to 100K AIC Series Rating

QS Breaker

Breaker Type	QS	QSH	QSHH	HQS	HQSH
Amperage	10K AIC	22K AIC	42K AIC	65K AIC	100K AIC
100	QS2100	QS2100H	QSH2100	QS2100HH	HQS2100H
125	QS2125	QS2125H	QSH2125	QS2125HH	HQS2125H
150	QS2150	QS2150H	QSH2150	QS2150HH	HQS2150H
175	QS2175	QS2175H	QSH2175	QS2175HH	HQS2175H
200	QS2200	QS2200H	QSH2200	QS2200HH	HQS2200H
225	QS2225	QS2225H	QSH2225	QS2225HH	HQS2225H

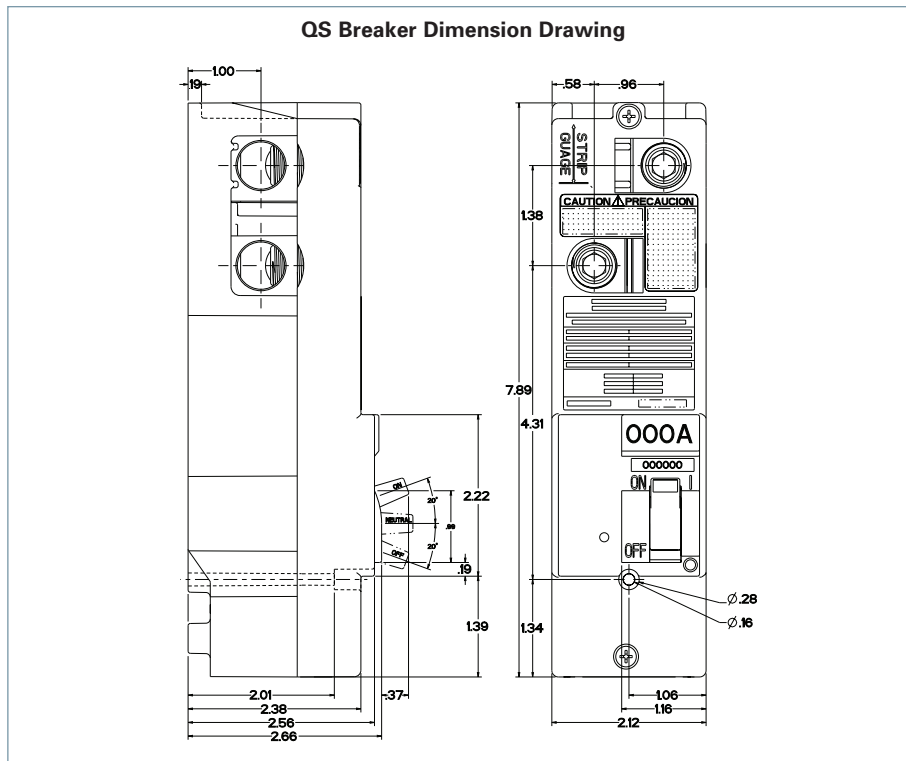

Front View



7
MOLDED CASE
CIRCUIT BREAKERS

^① For PowerMod information, please refer to Section 2, page 2-49

Circuit Breakers

Line Diagrams

Dimension Drawings

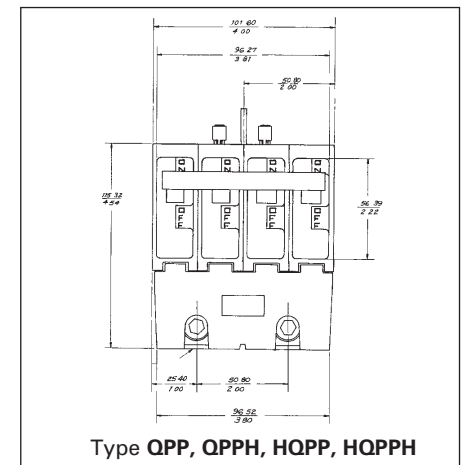
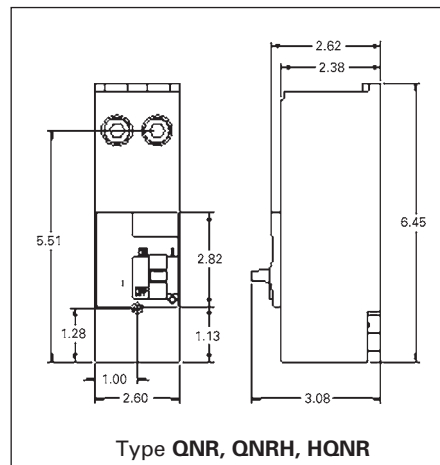
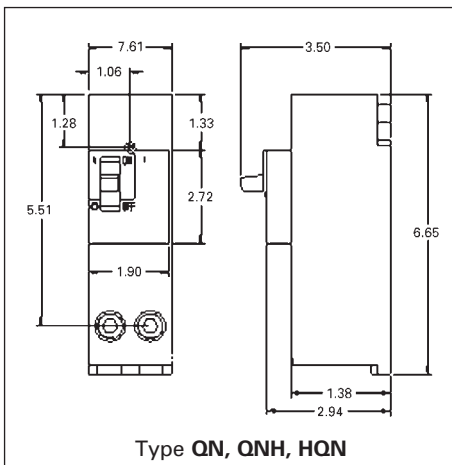
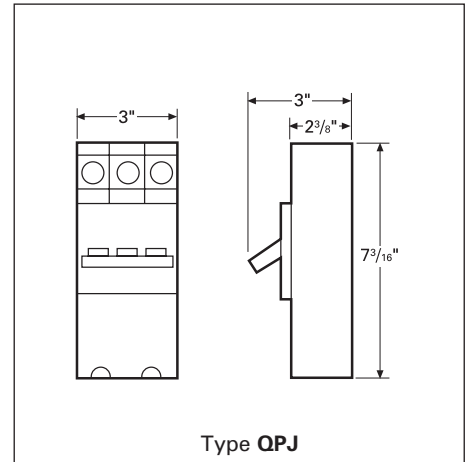
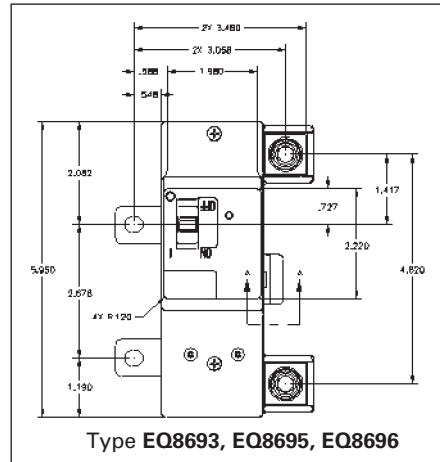
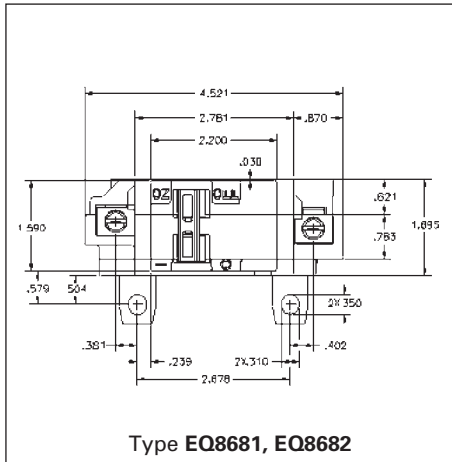
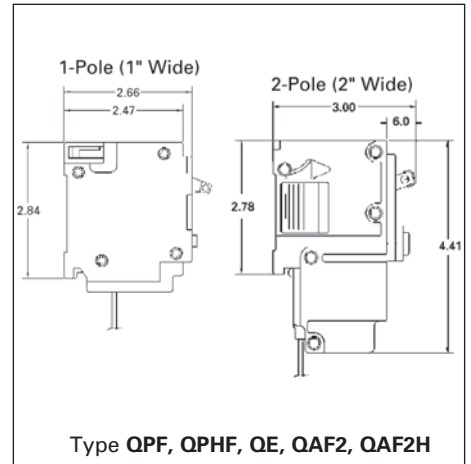
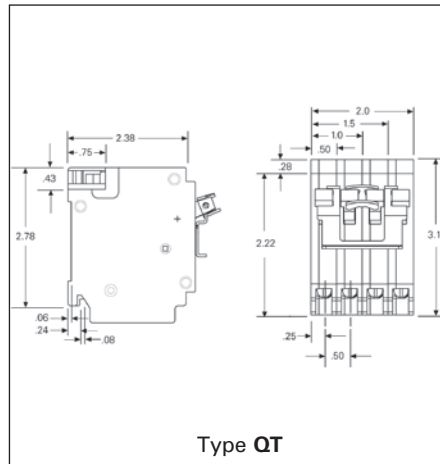
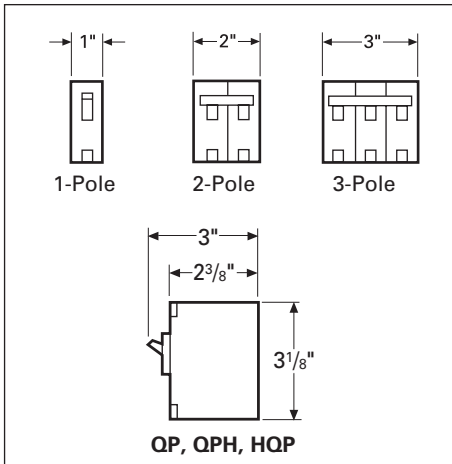

Ⓒ All standard circuit breakers are calibrated to 40°C maximum ambient application.

Circuit Breakers

Lug Data

Reference

Circuit Breaker Type	Circuit Breaker Ampere Rating	Cables Per Connector	Connector Wire Range
	LOAD SIDE		
QP, QPH, HQP, Plug-in	10	2	#14-#16 AWG Cu
	15-35	1	#14-#6 AWG Cu
		1	#14-#6 AWG Al
	40-50	1	#8-#6 AWG Cu
1		#8-#4 AWG Al	
55-125	1	#8-#2/0 AWG Cu	
	1	#8-#2/0 AWG Al	
QP 1 & 2-Pole Only	55-60	1	#6-#4 AWG Cu-Al (#3 AWG compatible with QPH & HQP)
QT	15-35	1	#14-#6 AWG Cu
		1	#14-#6 AWG Al
	40	1	#8 AWG CU-Al
QPF, QPHF	15-30	1	#14-#10 AWG Cu
		1	#12-#8 AWG Al
40-60	1	#8-#6 AWG Cu	
	1	#8-#4 AWG Al	
QAF2, QAFH2, QFGA2, QFGAH2	15-20	1	#14-#12 AWG Cu
QD	15-20	1	#12-#10 AWG Al
		2	#14-#8 AWG Cu Only
	15-20	1	#14-#12 AWG Cu
		1	#12-#10 AWG Al
	25-35	1	#10-#8 AWG Cu
1		#10-#6 AWG Al	
40-60	1	#8-#6 AWG Cu	
	1	#8-#4 AWG Al	
QN, QNH, HQN	150-200	1	#1-300kcmil Cu-Al
QS, QSH, QSHH, HQS, HQSH	100-225	1	#3-300kcmil Cu-Al
EQ8681-Ultimate	100	1	#4-3/0 AWG Cu-Al
EQ8682-Ultimate	125	1	#4-3/0 AWG Cu-Al
EQ8693-Ultimate	150	1	#1-300kcmil Cu-Al
EQ8695-Ultimate	200	1	#1-300kcmil Cu-Al
EQ8696-Ultimate	225	1	#1-300kcmil Cu-Al
QPP, QPPH, HQPP, HQPPH	125	1	#1 AWG Cu
		1	#2/0 AWG Al
	150	1	#1/0 AWG Cu
		1	#3/0 AWG Al
	175	1	#2/0 AWG Cu
1		#4/0 AWG Al	
200	1	#3/0 AWG Cu	
	1	250kcmil AWG Al	
225	1	#4/0 AWG Cu	
	1	300kcmil AWG Al	
EQ9675-EQIII	100	1	#8-#2/0 AWG Cu
EQ9677-EQIII	125	1	#8-#2/0 AWG Al
		1	#8-#2/0 AWG Al
EQ9683-EQIII	150	1	#1/0 AWG Cu
		1	#3/0 AWG Al
EQ9684	175	1	#3/0 AWG Cu
		1	250kcmil AWG AL
EQ9685-EQIII	200	1	#3/0 AWG Cu
		1	250kcmil AWG Al
EQ9686-EQIII	225	1	#4/0 AWG Cu
		1	300kcmil AWG Al
QPJ	125-200	1	#2-300kcmil Cu-Al

7
MOLDED CASE
CIRCUIT BREAKERS

Surge Protection

Circuit Breaker and Surge Protective Device (SPD)

Features

- 2 inch wide plug-on design
 - Includes (2) 1 Pole circuits breakers
 - No loss of load center spaces
- Easy to install and perfect for retrofit
- LEDs provide protection status

Benefits

By installing a Siemens Circuit Breaker and Surge Protective Device (SPD) in the load center of the residence, surge protection is provided for all branch circuits®.

Two green LED indicator lights are provided to show that surge protection is provided for all circuits connected to the load center. These breakers should be used for circuit protection of frequently used household or facility circuits because the lights and devices connected to these circuits provide an effective indication that surge protection is being provided.

The circuit breaker and SPD utilize Siemens-built 150V AC, 40mm, metal oxide varistors (MOVs). The maximum impulse rating for the SPD module is 40kA. The standard interrupting rating for the circuit breakers is 10k AIC. All Type QP circuit breakers and SPD are plug-on style, with load terminals provided. The devices are rated for 120/240V AC and are calibrated for 40 degrees C maximum ambient applications.



Breaker Type	Ampere Rating	Catalog Number	Surge Type
QP 1- Pole 120/240V AC 10K AIC	(2) 15	QSA1515SPD	SPD
	(2) 20	QSA2020SPD	SPD

Catalog Number	QSA1515SPD QSA2020SPD
Amperage	15 or 20 Amp
Number of Poles	(2) 1-Pole Circuit Breakers
Initial Clamping Level	240 Volts
Transient Energy Rating	360 Joules line-to-neutral 720 Joules line-to-line
Transient Suppression	500 volts peak, line-to-neutral
Voltage Rating	1000 volts peak, line-to-line
Peak Current Rating (impulse)	40,000 amperes
Discharge Voltage Characteristic	@ 1,500A, 600 volts @ 5,000A, 800 volts (both line-to-neutral)
Discharge Current Withstand Rating	10,000 amperes line-to-neutral
Circuit Breaker Interrupting Rating	10,000A, 120/240V AC
Listings/Certifications	UL, CSA Meets UL 1449 4th Edition

© For warranty information please refer to the surge website www.usa.siemens.com/surge

Molded Case Circuit Breakers

Panelboard Mounting with INSTA-WIRE

Selection

1-Pole Bolt-On (120V AC)^⑤

Continuous Current Rating @ 40° C	Type BL ^{①⑩}	Type BLH ^{①⑩}	Type HBL ^{①⑩}
	10,000A IR	22,000A IR	65,000A IR
	Catalog Number	Catalog Number	Catalog Number
10 ^⑨	B110	—	—
15	B115 ^④	B115H ^④	B115HH ^④
20	B120 ^④	B120H ^④	B120HH ^④
25	B125	B125H	B125HH
30	B130	B130H	B130HH
35	B135	B135H	B135HH
40	B140	B140H	B140HH
45	B145	B145H	B145HH
50	B150	B150H	B150HH
60	B160	B160H	B160HH
70	B170	B170H	B170HH



1-Pole

2-Pole Bolt-On (Common-Trip 120/240V AC)^⑥

10	B210	—	—
15	B215	B215H	B215HH
20	B220	B220H	B220HH
25	B225	B225H	B225HH
30	B230	B230H	B230HH
35	B235	B235H	B235HH
40	B240	B240H	B240HH
45	B245	B245H	B245HH
50	B250	B250H	B250HH
60	B260	B260H	B260HH
70	B270	B270H	B270HH
80	B280	B280H	B280HH
90	B290	B290H	B290HH
100	B2100	B2100H	B2100HH
110	B2110	B2110H	B2110HH
125	B2125	B2125H	B2125HH



2-Pole



3-Pole

2-Pole Bolt-On (Common-Trip 240V AC)^{③⑥⑩}

15	B215R	—	—
20	B220R	—	—
30	B230R	—	—
40	B240R	—	—
50	B250R	—	—

3-Pole Bolt-On (Common-Trip 240V AC)^⑦

15	B315	B315H	B315HH
20	B320	B320H	B320HH
25	B325	B325H	B325HH
30	B330	B330H	B330HH
35	B335	B335H	B335HH
40	B340	B340H	B340HH
45	B345	B345H	B345HH
50	B350	B350H	B350HH
60	B360	B360H	B360HH
70	B370	B370H	B370HH
80	B380	B380H	B380HH
90	B390	B390H	B390HH
100	B3100	B3100H	B3100HH

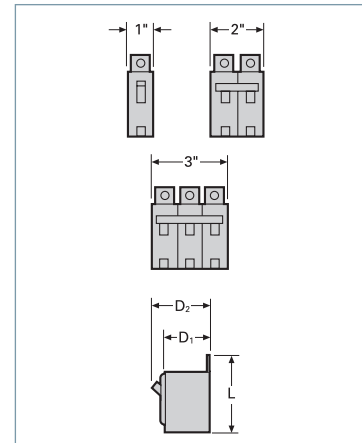

Breaker Type	Amperes	Dimensions		
		L	D1	D2
BL, BLH	15-50	3 ³ / ₁₆	2 ³ / ₈	3
BL, BLH	55-125	3 ³ / ₈	2 ³ / ₈	3
HBL	15-125	3 ³ / ₈	2 ³ / ₈	3

BL/BLH/HBL Internal Accessories

Description	Catalog Number	Field/Factory Installed
120VAC Shunt Trip	add suffix...00S01	Factory
24VAC Shunt Trip	add suffix...00S07	Factory
120V Auxiliary Switch	add suffix...01	Factory

Modifications

Description	Catalog Number
400Hz Calibration	add suffix...Y
Marine 50°C Ambient Calibration	add suffix...M
Fungus Proofing	add suffix...F

For external accessories, please refer to page 7-92

■ Built to order. Allow 2-3 weeks for delivery

① UL Listed for use with 60/75° wire through 40 amps, UL listed for use with 75° wire only for 50 amps and above, HACR rated. 120V AC Fluorescent Lighting. ② 1A and 1B contacts.

③ UL Listed for use on 3-phase grounded "B" systems — 10,000 for this application. ④ UL Listed for frequent switching applications (SWD). ⑤ Shipped 12 per sleeve. ⑥ Shipped 6 per sleeve.

⑦ Shipped 4 per sleeve. ⑧ UL Listed 5KA IR. ⑨ 10 Amp breaker does not have INSTA-WIRE. ⑩ For 3 Phase Applications. ⑪ UL Listed for reverse feed."

Molded Case Circuit Breakers

Panelboard Mounting Circuit Breakers

Selection

Arc-Fault Circuit Interrupters (AFCI)

AFCI's detect arcing faults (an unintentional arcing condition in a circuit) that standard circuit breakers are unable to detect. The device is intended to mitigate the effects of arcing faults by functioning to de-energize the circuit when an arc-fault is detected.

Combination Type AFCI

Detects all three possible types of arc fault: line-to-ground, line-to-neutral, and series.

Breaker Type	Ampere Rating	10,000 A IR Catalog Number	22,000 A IR Catalog Number	65,000 A IR Catalog Number
BAF2/BAFH2/HBAF2 1-Pole 120V AC	15	BA115AFC [Ⓞ]	BA115AFCH■	BA115AFCHH■
	20	BA120AFC [Ⓞ]	BA120AFCH■	BA120AFCHH■
BAF/BAFH 2-Pole 120/240V AC	15	B215AFC [Ⓞ]	B215AFCH■	—
	20	B220AFC [Ⓞ]	B220AFCH■	—

Branch-Feeder AFCI

Detects line-to-ground and line-to neutral arcs.

Breaker Type	Ampere Rating	10,000 A IR Catalog Number	22,000 A IR Catalog Number	65,000 A IR Catalog Number
BAF2/BAFH2/HBAF2 1-Pole 120V AC	15	BA115AF [Ⓞ]	BA115AFH■ [Ⓞ]	BA115AFHH■
	20	BA120AF [Ⓞ]	BA120AFH■ [Ⓞ]	BA120AFHH■

NEW Dual Function AFCI/GFCI

The Dual Function Circuit Breaker combines Combination Type AFCI and GFCI, protecting against both Arc Faults and (5mA) Ground Faults. The device includes the Self Test feature, making it the first in class in electrical safety for homeowners.

Breaker Type	Ampere Rating	10,000 A IR Catalog Number	22,000 A IR Catalog Number	65,000 A IR Catalog Number
BFGA2/BFGAH2/HBFGA2 1-Pole 120V AC	15	B115DF	B115DFH■	B115DFHH■
	20	B120DF	B120DFH■	B120DFHH■

Ground-Fault Circuit Interrupters (GFCI)

Provides Class A (5mA) ground fault protection. Intended for personnel protection. De-energizes the circuit for all ungrounded conductors of the circuit.

Breaker Type	Amp Rating	10k A IR Cat. No.	22k A IR Cat. No.	65k A IR Cat. No.
BLF/BLHF 1-Pole 120V AC Bolt-On	15	BF115A [Ⓞ]	BF115AH [Ⓞ]	BF115AHH■
	20	BF120A [Ⓞ]	BF120AH [Ⓞ]	BF120AHH■
	25	BF125A	BF125AH■	BF125AHH■
	30	BF130A	BF130AH	BF130AHH■
BLF/BLHF 2-Pole 120/240V AC Bolt-On	15	BF215A	BF215AH■	—
	20	BF220A	BF220AH■	—
	30	BF230A	BF230AH	—
	40	BF240A	BF240AH■	—
	50	BF250A	BF250AH■	—
	60	BF260A	BF260AH■	—

Ground Fault Equipment Protection (30mA)

Provides protection of equipment from damaging line-to-ground faults currents. De-energizes the circuit for all ungrounded conductors of the circuit.

Breaker Type	Amp Rating	10k A IR Cat. No.	22k A IR Cat. No.
BLE/ BLEH 1-Pole, 120V AC Bolt-On	15	BE115 [Ⓞ]	BE115H■ [Ⓞ]
	20	BE120 [Ⓞ]	BE120H■ [Ⓞ]
	30	BE130	BE130H■
BLE/ BLEH 2-Pole 120/240V AC Bolt-On	15	BE215	BE215H■
	20	BE220	BE220H■
	30	BE230	BE230H■
	40	BE240	BE240H■
	50	BE250	BE250H■
	60	BE260	BE260H■

• UL Listed

• HACR Rated

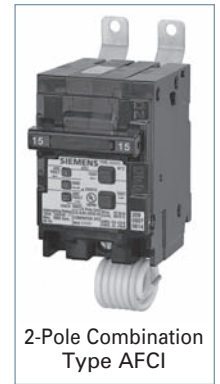

QAF2/QPF/QE Accessories

Description	Catalog Number
Padlocking Device 1-Pole	ECPLD1
Padlocking Device 2-Pole	ECPLD2
Handle Block	ECBX231M

Wiring Diagrams

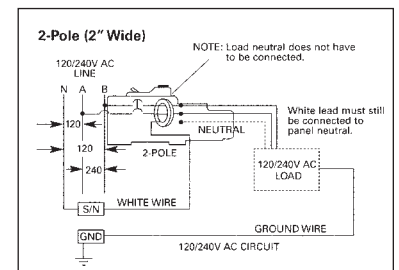
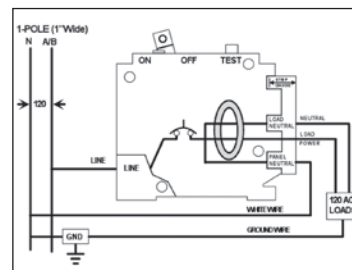

■ Built to order. Allow 8 -10 weeks for delivery.
 Ⓞ UL Listed as SWD (Switching Duty) Rated, suitable for 120V AC Fluorescent Lighting.

Molded Case Circuit Breakers

Special Application Breakers

Switching Neutrals^①

Breaker Type	Ampere Rating	Catalog Number
BLG 2-Wire Common Trip	15 20	BG215 ■ BG220 ■
BLG 3-Wire Common Trip	30	BG330 ■

HID Lighting^①

For high-intensity discharge lamp loads having in-rush currents above the instantaneous trip setting of a standard breaker.

BL 1-Pole	15	B115HID ②■
	20	B120HID ②
	30	B130HID ■
BL 2-Pole	15	B215HID ②■
	20	B220HID ②
	30	B230HID ■

Molded Case Switch

For applications that do not require overcurrent protection.

BL 2-Pole	30	B230S
---------------------	----	--------------

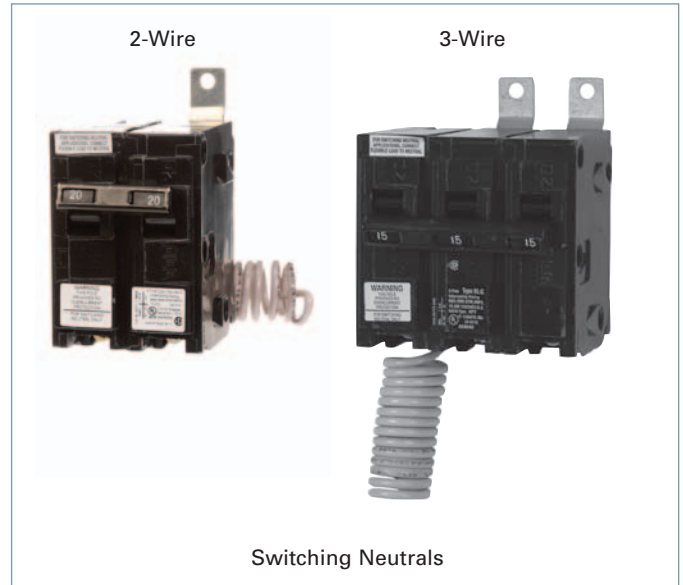

■ Built to order. Allow 2–3 weeks for delivery.

① HACR rated.

② UL Listed for frequent switching applications (SWD). 120V AC fluorescent lighting.

Molded Case Circuit Breakers

BOD 100A Frame Panelboard Mounting Circuit Breakers

Selection/Dimensions

BOD[®]

Continuous Current Rating @ 40°C	1-Pole	2-Pole [®]	3-Pole [®]
	277V AC–125V DC	480Y/277V AC–125/250V DC	480Y/277V AC
	Catalog Number	Catalog Number	Catalog Number
15	BOD115 ^{①②}	BOD215 ^③	BOD315 ^③
20	BOD120 ^{①②}	BOD220 ^③	BOD320 ^③
25	BOD125 ^②	BOD225 ^③	BOD325 ^③
30	BOD130 ^②	BOD230 ^③	BOD330 ^③
35	BOD135 ^②	BOD235 ^③	BOD335 ^③
40	BOD140 ^②	BOD240 ^③	BOD340 ^③
45	BOD145 ^{②■}	BOD245 ^③	BOD345 ^③
50	BOD150 ^②	BOD250 ^③	BOD350 ^③
60	BOD160	BOD260	BOD360
70	BOD170■	BOD270	BOD370
80	BOD180■	BOD280	BOD380
90	BOD190■	BOD290	BOD390
100	BOD1100■	BOD2100	BOD3100

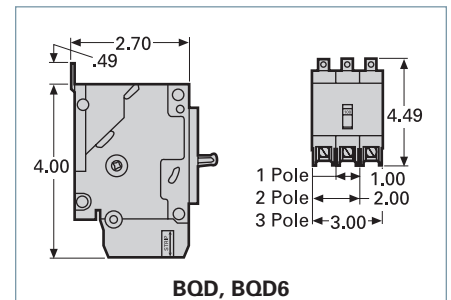

BOD6 CSA Certified

Continuous Current Rating @ 40°C	1-Pole	2-Pole [®]	3-Pole [®]
	347V AC	600/347V AC	600/347V AC
	Catalog Number	Catalog Number	Catalog Number
15	BOD6115 ^①	BOD6215	BOD6315
20	BOD6120 ^①	BOD6220	BOD6320
25	BOD6125■	BOD6225■	BOD6325■
30	BOD6130	BOD6230	BOD6330
35	BOD6135■	BOD6235■	BOD6335■
40	BOD6140■	BOD6240■	BOD6340
45	BOD6145■	BOD6245■	BOD6345■
50	BOD6150■	BOD6250■	BOD6350
60	BOD6160■	BOD6260■	BOD6360
70	BOD6170■	BOD6270■	BOD6370

Shipping Weights

Number of Poles	Number per Carton	Shipping Weight (lbs.) (ea.)
1	1/12/48	.6
2	1/6/24	1.2
3	1/4/16	2.0

Interrupting Ratings (max. RMS symmetrical amperes kA)

Breaker Type	Number of Poles	UL								IEC 947-2 [®]			
		Volts AC						Volts DC		Volts AC			
		120	240	277	480/277	347	600/347	125	125/250	220/240		380/415	
									I_{cu}	I_{cs}	I_{cu}	I_{cs}	
BOD	1-Pole	65	—	14	—	—	—	14	—	18	9	—	—
	2-Pole	—	65	—	14	—	—	—	14	65	33	18	9
	3-Pole	—	65	—	14	—	—	—	14	65	33	18	9
BOD6	1-Pole	65	—	—	—	10	—	14	—	18	9	—	—
	2-Pole	—	65	—	—	—	10	—	14	65	33	18	9
	3-Pole	—	65	—	—	—	10	—	—	65	33	18	9

Lugs For 60/75°C Wire

BOD – Load End Only	
15–40	#14–#6 AWG Cu #12–#6 AWG Al
45–100	#8–#1 AWG Cu #6–#1/0 AWG Al

For inches / millimeters conversion, see Application Data section.

■ Built to order. Allow 2–3 weeks for delivery.

① SWD rated for switching fluorescent lighting.
② HID rated at 277V AC.

③ Not suitable for 3-phase delta 480V applications.

④ HACR rated.

⑤ HID rated at 480Y/277V AC.

⑥ Applicable for 15–30A breakers only

For external accessories, please refer to pages 7-94 to 7-99
For internal accessories, please refer to page 7-35

Molded Case Circuit Breakers

GB Frame

Selection

Type NGB Frame[®] (Panelboard Mount)

Continuous Current Rating @ 40°C	1-Pole	2-Pole	3-Pole
	Catalog Number	Catalog Number	Catalog Number
15	NGB1B015B ^{①②}	NGB2B015B ^②	NGB3B015B ^②
20	NGB1B020B ^{①②}	NGB2B020B ^②	NGB3B020B ^②
25	NGB1B025B ^②	NGB2B025B ^②	NGB3B025B ^②
30	NGB1B030B ^②	NGB2B030B ^②	NGB3B030B ^②
35	NGB1B035B ^②	NGB2B035B ^②	NGB3B035B ^②
40	NGB1B040B ^②	NGB2B040B ^②	NGB3B040B ^②
45	NGB1B045B ^②	NGB2B045B ^②	NGB3B045B ^②
50	NGB1B050B ^②	NGB2B050B ^②	NGB3B050B ^②
60	NGB1B060B	NGB2B060B	NGB3B060B
70	NGB1B070B	NGB2B070B	NGB3B070B
80	NGB1B080B	NGB2B080B	NGB3B080B
90	NGB1B090B	NGB2B090B	NGB3B090B
100	NGB1B100B	NGB2B100B	NGB3B100B
110	NGB1B110B	NGB2B110B	NGB3B110B
125	NGB1B125B	NGB2B125B	NGB3B125B



Load lugs are included as standard. HACR rated.

Type HGB[®] (Panelboard Mount)

Continuous Current Rating @ 40°C	1-Pole	2-Pole	3-Pole
	Catalog Number	Catalog Number	Catalog Number
15	HGB1B015B ^{①②}	HGB2B015B ^②	HGB3B015B ^②
20	HGB1B020B ^{①②}	HGB2B020B ^②	HGB3B020B ^②
25	HGB1B025B ^②	HGB2B025B ^②	HGB3B025B ^②
30	HGB1B030B ^②	HGB2B030B ^②	HGB3B030B ^②
35	HGB1B035B ^②	HGB2B035B ^②	HGB3B035B ^②
40	HGB1B040B ^②	HGB2B040B ^②	HGB3B040B ^②
45	HGB1B045B ^②	HGB2B045B ^②	HGB3B045B ^②
50	HGB1B050B ^②	HGB2B050B ^②	HGB3B050B ^②
60	HGB1B060B	HGB2B060B	HGB3B060B
70	HGB1B070B	HGB2B070B	HGB3B070B
80	HGB1B080B	HGB2B080B	HGB3B080B
90	HGB1B090B	HGB2B090B	HGB3B090B
100	HGB1B100B	HGB2B100B	HGB3B100B
110	HGB1B110B	HGB2B110B	HGB3B110B
125	HGB1B125B	HGB2B125B	HGB3B125B

Type LGB[®] (Panelboard Mount)

Continuous Current Rating @ 40°C	1-Pole	2-Pole	3-Pole
	Catalog Number	Catalog Number	Catalog Number
15	LGB1B015B ^{①②}	LGB2B015B ^②	LGB3B015B ^②
20	LGB1B020B ^{①②}	LGB2B020B ^②	LGB3B020B ^②
25	LGB1B025B ^②	LGB2B025B ^②	LGB3B025B ^②
30	LGB1B030B ^②	LGB2B030B ^②	LGB3B030B ^②
35	LGB1B035B ^②	LGB2B035B ^②	LGB3B035B ^②
40	LGB1B040B ^②	LGB2B040B ^②	LGB3B040B ^②
45	LGB1B045B ^②	LGB2B045B ^②	LGB3B045B ^②
50	LGB1B050B ^②	LGB2B050B ^②	LGB3B050B ^②
60	LGB1B060B	LGB2B060B	LGB3B060B
70	LGB1B070B	LGB2B070B	LGB3B070B
80	LGB1B080B	LGB2B080B	LGB3B080B
90	LGB1B090B	LGB2B090B	LGB3B090B
100	LGB1B100B	LGB2B100B	LGB3B100B
110	LGB1B110B	LGB2B110B	LGB3B110B
125	LGB1B125B	LGB2B125B	LGB3B125B

Shipping Weights

Number of Poles	Number per Carton	Shipping Weight lbs. (kg)
1	1	0.9 (0.4)
2	1	1.9 (0.9)
3	1	2.9 (1.2)

Lugs for 60/75°C Wire

Type	Ampere Rating	Wire Size	Catalog Number
NGB HGB LGB	15-30A	#14-#6 AWG Cu	TC1Q1 (qty. 1)
		#12-#6 AWG Al	3TC1Q1 (qty. 3)
	35-125A	#8-1/0 AWG Cu	3TC1GG20
		#8-2/0 AWG Al	

Interrupting Ratings (max. RMS symmetrical amperes kA)

	Poles	UL489							
		Volts AC						Volts DC	
		120	240	277	347	480Y/277	600Y/347	125	125/250
NGB	1	100	—	25	14	—	—	14	—
	2,3	—	100	—	—	25	14	—	14 ^④
HGB	1	100	—	35	14	—	—	14	—
	2,3	—	100	—	—	35	14	—	14 ^④
LGB	1	100	—	65	14	—	—	14	—
	2,3	—	100	—	—	65	14	—	14 ^④

① SWD rated.
② HID rated.

③ 2-pole only.
④ 2-pole only or two outer poles of 3-pole breaker
⑤ UL Listed for reverse feed.

For external accessories, please refer to pages 7-94 to 7-99
For internal accessories, please refer to page 7-35

Molded Case Circuit Breakers

GB2 Frame

Selection

Type NGB2[®] (Panelboard Mount)

Continuous Current Rating @ 40°C	1-Pole	2-Pole	3-Pole
	Catalog Number	Catalog Number	Catalog Number
15	NGB1K015B ^{①②}	NGB2K015B ^②	NGB3K015B ^②
20	NGB1K020B ^{①②}	NGB2K020B ^②	NGB3K020B ^②
25	NGB1K025B ^②	NGB2K025B ^②	NGB3K025B ^②
30	NGB1K030B ^②	NGB2K030B ^②	NGB3K030B ^②
35	NGB1K035B ^②	NGB2K035B ^②	NGB3K035B ^②
40	NGB1K040B ^②	NGB2K040B ^②	NGB3K040B ^②
45	NGB1K045B ^②	NGB2K045B ^②	NGB3K045B ^②
50	NGB1K050B ^②	NGB2K050B ^②	NGB3K050B ^②
60	NGB1K060B	NGB2K060B	NGB3K060B
70	NGB1K070B	NGB2K070B	NGB3K070B
80	NGB1K080B	NGB2K080B	NGB3K080B
90	NGB1K090B	NGB2K090B	NGB3K090B
100	NGB1K100B	NGB2K100B	NGB3K100B
110	NGB1K110B	NGB2K110B	NGB3K110B
125	NGB1K125B	NGB2K125B	NGB3K125B



LGB3K125B

Load lugs are included as standard. HACR rated.

Type HGB2[®] (Panelboard Mount)

Continuous Current Rating @ 40°C	1-Pole	2-Pole	3-Pole
	Catalog Number	Catalog Number	Catalog Number
15	HGB1K015B ^{①②}	HGB2K015B ^②	HGB3K015B ^②
20	HGB1K020B ^{①②}	HGB2K020B ^②	HGB3K020B ^②
25	HGB1K025B ^②	HGB2K025B ^②	HGB3K025B ^②
30	HGB1K030B ^②	HGB2K030B ^②	HGB3K030B ^②
35	HGB1K035B ^②	HGB2K035B ^②	HGB3K035B ^②
40	HGB1K040B ^②	HGB2K040B ^②	HGB3K040B ^②
45	HGB1K045B ^②	HGB2K045B ^②	HGB3K045B ^②
50	HGB1K050B ^②	HGB2K050B ^②	HGB3K050B ^②
60	HGB1K060B	HGB2K060B	HGB3K060B
70	HGB1K070B	HGB2K070B	HGB3K070B
80	HGB1K080B	HGB2K080B	HGB3K080B
90	HGB1K090B	HGB2K090B	HGB3K090B
100	HGB1K100B	HGB2K100B	HGB3K100B
110	HGB1K110B	HGB2K110B	HGB3K110B
125	HGB1K125B	HGB2K125B	HGB3K125B

Type LGB2[®] (Panelboard Mount)

Continuous Current Rating @ 40°C	1-Pole	2-Pole	3-Pole
	Catalog Number	Catalog Number	Catalog Number
15	LGB1K015B ^{①②}	LGB2K015B ^②	LGB3K015B ^②
20	LGB1K020B ^{①②}	LGB2K020B ^②	LGB3K020B ^②
25	LGB1K025B ^②	LGB2K025B ^②	LGB3K025B ^②
30	LGB1K030B ^②	LGB2K030B ^②	LGB3K030B ^②
35	LGB1K035B ^②	LGB2K035B ^②	LGB3K035B ^②
40	LGB1K040B ^②	LGB2K040B ^②	LGB3K040B ^②
45	LGB1K045B ^②	LGB2K045B ^②	LGB3K045B ^②
50	LGB1K050B ^②	LGB2K050B ^②	LGB3K050B ^②
60	LGB1K060B	LGB2K060B	LGB3K060B
70	LGB1K070B	LGB2K070B	LGB3K070B
80	LGB1K080B	LGB2K080B	LGB3K080B
90	LGB1K090B	LGB2K090B	LGB3K090B
100	LGB1K100B	LGB2K100B	LGB3K100B
110	LGB1K110B	LGB2K110B	LGB3K110B
125	LGB1K125B	LGB2K125B	LGB3K125B

Shipping Weights

Number of Poles	Number per Carton	Shipping Weight lbs. (kg)
1	1	.75 (.34)
2	1	1.3 (.59)
3	1	2.0 (.98)

Lugs for 60/75°C Wire

Type	Ampere Rating	Wire Size	Catalog Number
NGB2 HGB2 LGB2	15-30A	#14-#6 AWG Cu	TC1Q1 (qty. 1)
		#12-#6 AWG Al	3TC1Q1 (qty. 3)
	35-125A	#8-1/0 AWG Cu	3TC1GG20
		#8-2/0 AWG Al	

Interrupting Ratings (max. RMS symmetrical amperes kA)

Type	Poles	UL 489							
		Volts AC						Volts DC	
		120	240	277	480	347	600Y/347	125	125/250
NGB2	1	100	—	25	—	14	—	14	—
	2, 3	—	100	—	25	—	14	—	14 ^④
HGB2	1	100	—	35	—	22	—	14	—
	2, 3	—	100	—	35	—	22	—	14 ^④
LGB2	1	100	—	65	—	25	—	14	—
	2, 3	—	100	—	65	—	25	—	14 ^④

① SWD rated.
② HID rated.
③ 2-pole only.

④ 2-pole only or two outer poles of 3-pole breaker
⑤ Suitable for reverse feed applications
⑥ 3 pole breakers suitable for single phase applications

For external accessories, please refer to pages 7-94 to 7-99
For internal accessories, please refer to page 7-35

Molded Case Circuit Breakers

Accessories^①

Selection

Shunt Trip

Control Voltage		Catalog Number
V AC	V DC	
120	—	CQDST120
240	—	CQDST240▲
277	—	CQDST277▲
480	—	CQDST480▲
600	—	CQDST600
—	12	CQDST12
—	24	CQDST24
—	48	CQDST48
—	125	CQDST125



Auxiliary Switch

Maximum Voltage		Number of Contacts	Catalog Number
AC	DC		
240	125	1A-1B	CQDA1
240	125	2A-2B	CQDA2

Alarm Switch

Maximum Voltage		Catalog Number
AC	DC	
240	125	CQDBA

Shunt Trip and Auxiliary Switch Combinations

Shunt Trip Voltage		Catalog Number
AC	DC	
24	—	CQDST24AAS▲
120	—	CQDST120AAS▲
240	—	CQDST240AAS▲
277	—	CQDST277AAS▲
480	—	CQDST480AAS▲
600	—	CQDST600AAS▲
—	12	CQDST12DAS▲
—	24	CQDST24DAS▲
—	48	CQDST48DAS▲
—	125	CQDST125DAS▲

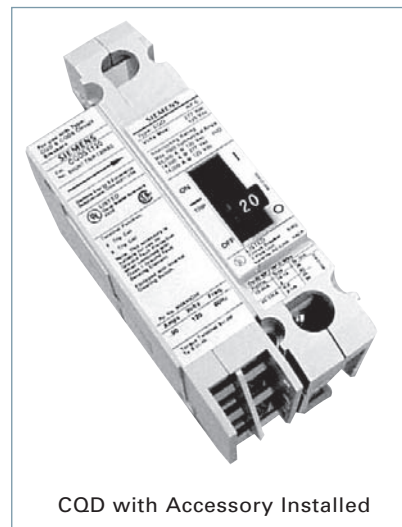

Alarm and Auxiliary Switch Combinations

For Breaker	Catalog Number
BQD, BQD6, CQD, CQD6, NGG, HGG, LGG, NGB, HGB, HGB, LGB, NGB2, HGB2 and LGB2	CQDA1BA▲

▲ Built to order. Allow 6-8 weeks for delivery.

① Adds 1-pole space for accessory.

Circuit Breakers

Lug-In/Lug-Out with INSTA-WIRE

Selection

All BQ/BQH/HBQ circuit breakers are supplied with load side lugs. If line side lugs are required, add suffix "L" to catalog number. Consult Siemens for any additional charge. All standard circuit breakers are calibrated for 40°C maximum ambient application.

Continuous Current Rating @ 40° C	Type BQ ^①	Type BQH	Type HBQ
	10,000A IR Catalog Number	22,000A IR Catalog Number	65,000A IR Catalog Number

1-Pole (120V AC)^⑤

Rating	Type BQ ^①	Type BQH	Type HBQ
15	BQ1B015 ^④	BQ1B015H ^④	HB1B015 ^④
20	BQ1B020 ^④	BQ1B020H ^④	HB1B020 ^④
25	BQ1B025	BQ1B025H	HB1B025
30	BQ1B030	BQ1B030H	HB1B030
35	BQ1B035	BQ1B035H	HB1B035
40	BQ1B040	BQ1B040H	HB1B040
45	BQ1B045	—	HB1B045
50	BQ1B050	BQ1B050H	HB1B050
60	BQ1B060 ^②	BQ1B060H	HB1B060
70	BQ1B070	BQ1B070H	HB1B070

2-Pole (Common-Trip 120/240V AC)^⑥

Rating	Type BQ ^①	Type BQH	Type HBQ
15	BQ2B015	BQ2B015H	HB2B015
20	BQ2B020	BQ2B020H	HB2B020
25	BQ2B025	BQ2B025H	HB2B025
30	BQ2B030	BQ2B030H	HB2B030
35	BQ2B035	BQ2B035H	HB2B035
40	BQ2B040	BQ2B040H	HB2B040
45	BQ2B045	—	HB2B045
50	BQ2B050	BQ2B050H	HB2B050
60	BQ2B060 ^②	BQ2B060H	HB2B060
70	BQ2B070	BQ2B070H	HB2B070
80	BQ2B080	BQ2B080H	HB2B080
90	BQ2B090	BQ2B090H	HB2B090
100	BQ2B100	BQ2B100H	HB2B100
110	BQ2B110	—	HB2B110
125	BQ2B125	BQ2B125H	HB2B125

2-Pole (Common-Trip 240V AC)^{③⑥}

Rating	Type BQ ^①	Type BQH	Type HBQ
15	BQ2H015	—	—
20	BQ2H020	—	—
30	BQ2H030	—	—
40	BQ2H040	—	—
50	BQ2H050	—	—
60	BQ2H060	—	—
70	BQ2H070	—	—
80	BQ2H080	—	—
90	BQ2H090	—	—
100	BQ2H100	—	—

3-Pole (Common-Trip 240V AC)^⑦

Rating	Type BQ ^①	Type BQH	Type HBQ
15	BQ3B015	BQ3B015H	HB3B015
20	BQ3B020	BQ3B020H	HB3B020
25	BQ3B025	BQ3B025H	HB3B025
30	BQ3B030	BQ3B030H	HB3B030
35	BQ3B035	BQ3B035H	HB3B035
40	BQ3B040	BQ3B040H	HB3B040
45	BQ3B045	BQ3B045H	HB3B045
50	BQ3B050	BQ3B050H	HB3B050
60	BQ3B060	BQ3B060H	HB3B060
70	BQ3B070	BQ3B070H	HB3B070
80	BQ3B080	BQ3B080H	HB3B080
90	BQ3B090	BQ3B090H	HB3B090
100	BQ3B100	BQ3B100H	HB3B100

BQ / BQH / HBQ Internal Accessories

Description	Catalog Number	Field/Factory Installed
120VAC Shunt Trip	add suffix...00S01	Factory
24VAC Shunt Trip	add suffix...00S07	Factory
120V Auxiliary Switch	add suffix...01 ^②	Factory

■ Built to order. Allow 2-3 weeks for delivery
 ① UL Listed for use with 60/75° wire through 40 amps, UL listed for use with 75° wire only for 50 amps and above, HACR rated.

② 1A and 1B contacts.
 ③ UL Listed for use on 3-phase grounded "B" systems — 10,000 for this application.
 ④ UL Listed for frequent switching applications (SWD). 120V AC Fluorescent Lighting.

⑤ Shipped 12 per sleeve.
 ⑥ Shipped 6 per sleeve.
 ⑦ Shipped 4 per sleeve.
 ⑧ UL Listed 5KA IR.
 ⑨ Refer to Table A on page 7-87

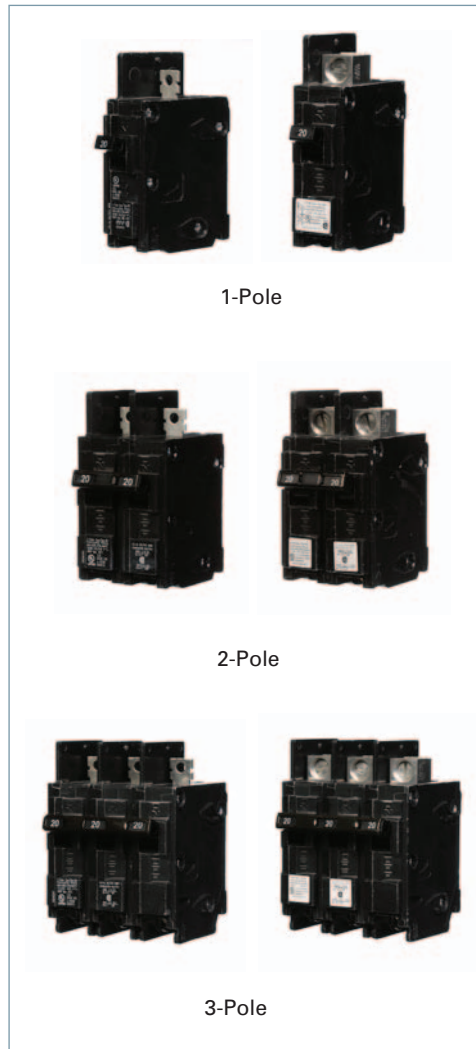

Factory Modifications

Description	Catalog Number
Line Side Lugs	add suffix...L
Quick Connect Lug	add suffix...QX
400Hz Calibration	add suffix...Y ^⑧
Marine 50° C Ambient Calibration	add suffix...M
Fungus Proofing	add suffix...F

For external accessories, please refer to page 7-92

Molded Case Circuit Breakers

DIN Rail Mounted Circuit Breakers

Selection/Dimensions

Breaker Type	Ampere Rating	Catalog Number	Line Side Connector	Load Side Connector	Interrupting Ratings (KA) (RMS Symmetrical Amperes) Volts AC	
					120	120/240

1-Pole DIN Rail (120V AC)

BQLD 1-Pole 120V DIN Rail	10	BQ1B010QLD	TC1Q1	TC1Q1	10	
	15	BQ1B015QLD	TC1Q1	TC1Q1	10	
	20	BQ1B020QLD	TC1Q1	TC1Q1	10	
	25	BQ1B025QLD	TC1Q1	TC1Q1	10	
	30	BQ1B030QLD	TC1Q1	TC1Q1	10	
	35	BQ1B035QLD	TC1Q1	TC1Q1	10	
	40	BQ1B040QLD	TC1Q1	TC1Q1	10	
BQXD 1-Pole 120V DIN Rail	45	BQ1B045QLD	TA1Q1	TA1Q1	10	
	50	BQ1B050QLD	TA1Q1	TA1Q1	10	
	60	BQ1B060QLD	TA1Q1	TA1Q1	10	
	10	BQ1B010QXD	TC1Q1	Quick-Connect	10	
	15	BQ1B015QXD	TC1Q1	Quick-Connect	10	
	20	BQ1B020QXD	TC1Q1	Quick-Connect	10	
	25	BQ1B025QXD	TC1Q1	Quick-Connect	10	
BQXD 1-Pole 120V DIN Rail	30	BQ1B030QXD	TC1Q1	Quick-Connect	10	
	35	BQ1B035QXD	TC1Q1	Quick-Connect	10	
	40	BQ1B040QXD	TC1Q1	Quick-Connect	10	
	45	BQ1B045QXD	TA1Q1	Quick-Connect	10	
	50	BQ1B050QXD	TA1Q1	Quick-Connect	10	
	60	BQ1B060QXD	TA1Q1	Quick-Connect	10	

2-Pole DIN Rail (120/240V AC)

BQLD 2-Pole 120/240V DIN Rail	10	BQ2B010QLD	TC1Q1	TC1Q1		10
	15	BQ2B015QLD	TC1Q1	TC1Q1		10
	20	BQ2B020QLD	TC1Q1	TC1Q1		10
	25	BQ2B025QLD	TC1Q1	TC1Q1		10
	30	BQ2B030QLD	TC1Q1	TC1Q1		10
	35	BQ2B035QLD	TC1Q1	TC1Q1		10
	40	BQ2B040QLD	TC1Q1	TC1Q1		10
BQXD 2-Pole 120/240V DIN Rail	45	BQ2B045QLD	TA1Q1	TA1Q1		10
	50	BQ2B050QLD	TA1Q1	TA1Q1		10
	60	BQ2B060QLD	TA1Q1	TA1Q1		10
	10	BQ2B010QXD	TC1Q1	Quick-Connect		10
	15	BQ2B015QXD	TC1Q1	Quick-Connect		10
	20	BQ2B020QXD	TC1Q1	Quick-Connect		10
	25	BQ2B025QXD	TC1Q1	Quick-Connect		10
BQXD 2-Pole 120/240V DIN Rail	30	BQ2B030QXD	TC1Q1	Quick-Connect		10
	35	BQ2B035QXD	TC1Q1	Quick-Connect		10
	40	BQ2B040QXD	TC1Q1	Quick-Connect		10
	45	BQ2B045QXD	TA1Q1	Quick-Connect		10
	50	BQ2B050QXD	TA1Q1	Quick-Connect		10
	60	BQ2B060QXD	TA1Q1	Quick-Connect		10

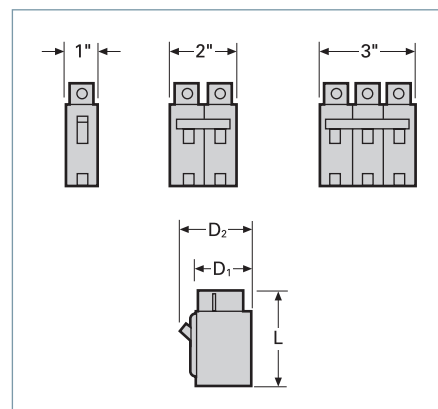
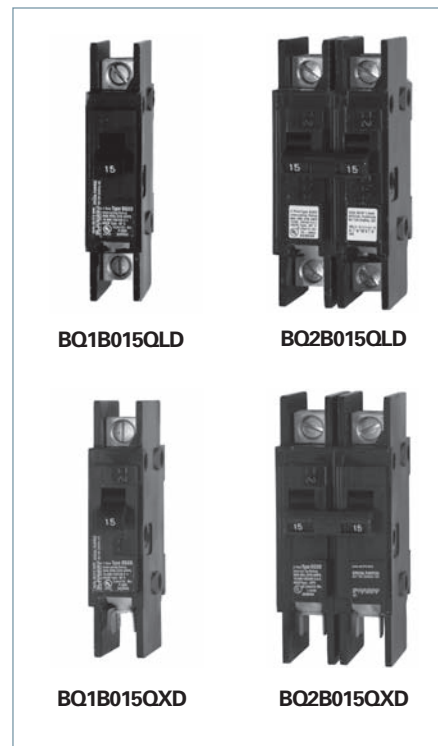

Lugs-For Use with BQXD[®]

Circuit Breaker Amp. Rtg.	Cab. Per Lug	Lug Wire Range AWG	Catalog Number
Line Side			
10-40	1	#16-#6 Cu	TC1Q1 ^{①②}
	1	#12-#6 Al	
45-125	1	#8-#1 Cu	TA1Q1
	1	#6-#1/0 Al	

Finger Safe Terminal Shield

Protects against accidental contact with lugs-1 per lug. Fits line and load end.

Catalog Number	Qty
BQFS2	2
BQFS1K	1000

Enclosures	
Type	Catalog Number ^③
1	EB3100S ^{③⑤}
3R	WB3100

Breaker Type	Amperes	Dimensions (inches)		
		L	D1	D2
BQ, BQH	15-50	3¾	2¾	3
BQ, BQH	55-125	4	2¾	3
HBO	15-125	4	2¾	3
BQXD	15-60	4½	2¾	3

For inches / millimeters conversion, see Application Data section.

■ Built to order. Allow 2-3 weeks for delivery.

① UL Listed for use with 60/75° wire through 40 amps.
UL listed for use with 75° wire only for 50 amps and above, HACR rated.

② Connector has steel construction.

③ Surface mounted indoor. If flush mounting is required, replace suffix "S" in catalog number with suffix "F".

④ Neutral included in enclosure.

⑤ Enclosure will not accept circuit breakers with shunt trips or auxiliary switches installed.

⑥ Type BQXD uses TA1Q1 or TC1Q1 lugs on line side of circuit breaker.

Enclosures, see Section 6
For external accessories, please refer to pages 7-92, 7-94 to 7-99

Molded Case Circuit Breakers

QR 250A Frame

Selection/Dimensions

Continuous Current Rating @ 40°C	2-Pole 240V AC Catalog Number	3-Pole 240V AC Catalog Number
----------------------------------	-------------------------------	-------------------------------

Type QR2^②

100	QR22B100	QR23B100
125	QR22B125	QR23B125
150	QR22B150	QR23B150
175	QR22B175	QR23B175
200	QR22B200	QR23B200
225	QR22B225	QR23B225
250	QR22B250	QR23B250

Type QRH2^②

100	QRH22B100■	QRH23B100
125	QRH22B125	QRH23B125
150	QRH22B150	QRH23B150
175	QRH22B175■	QRH23B175
200	QRH22B200	QRH23B200
225	QRH22B225	QRH23B225
250	QRH22B250	QRH23B250

Type HQR2^②

100	HQR22B100■	HQR23B100
125	HQR22B125	HQR23B125
150	HQR22B150	HQR23B150
175	HQR22B175■	HQR23B175
200	HQR22B200	HQR23B200
225	HQR22B225	HQR23B225
250	HQR22B250	HQR23B250

Type HQR2H^②

100	HQR22B100H	HQR23B100H
125	HQR22B125H	HQR23B125H
150	HQR22B150H	HQR23B150H
175	HQR22B175H	HQR23B175H
200	HQR22B200H	HQR23B200H
225	HQR22B225H	HQR23B225H
250	HQR22B250H	HQR23B250H

Ordering Information

Load side 3TA1QR300 lugs are mounted and included when circuit breaker is ordered. For line and load lugs (3TA1QR300) installed at no additional charge, add suffix "L" to catalog number.

50°C Calibration - See page 7-90.

400HZ. - See page 7-90.

Shipping Weights

Number of Poles	Number per Carton	Shipping Weight (lbs.)
2	1	3.2
3	1	4.5

Lugs For 75°C Wire^①

Catalog Number	Lug Body	Lug Wire Range
3TA1QR300	Al	#3 - 300 Kcmil Al/Cu
3TC1QR250	Cu	#3 - 300 Kcmil Cu ONLY
CCQ250	CMP	#6 AWG - 350kcmil Al/Cu

Enclosures (Neutral Included)

Type	Catalog Number
1	QR2N1(S) or (F)
3R	QR2N3R3
12	QR2N12
4X	QR2N4X
4X316	QR2N4X316

UL 489 Interrupting Ratings

Breaker Type	RMS Symmetrical Amperes (kA) Volts AC (50/60 Hz)
	240
QR2	10
QRH2	25
HQR2	65
HQR2H	100

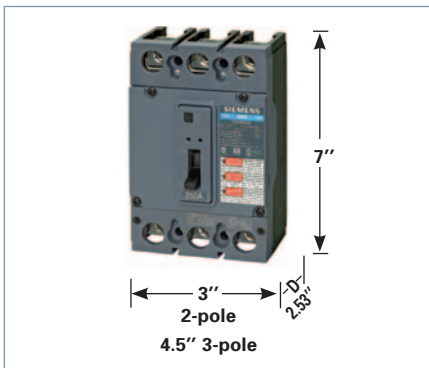

■ Built to order. Allow 2-3 weeks for delivery.

① See Note: A page 7-81.

Note: QR breakers are UL Listed for reverse feed applications.

② HACR rated.

Enclosures Section 6
For external accessories, please refer to pages 7-94 to 7-99

Molded Case Circuit Breakers

QR Accessories

Selection

Shunt Trip

Control Voltage		In Rush	Shunt Trip	Shunt Trip and Auxiliary Switch Combination
AC	DC		Catalog Number	Catalog Number
—	24	1.1A	S07QR2	S07QR2A
120 - 240	48	2.0A AC / 1.8A DC	S01QR2	S01QR2A

Auxiliary Switch

Contains (1) or (2) sets of "A" contacts and "B" contacts

Maximum Control Supply Voltage (V)	Maximum Allowable Current (A)	Single Auxiliary 1A - 1B Contact Catalog Number	Double Auxiliary 2A - 2B Contact Catalog Number
250 AC / 125 DC	5 AC / 0.5 DC	A01QR2	A02QR2

External Accessories

Description	Catalog Number
Padlock Device	HPLQR
Mounting Screw Kit	MSQR3
Handle Blocking Device	HBLQR
Handle Sliding-bar Interlock	SBMIQR

Padlock Device HPLQR



Handle Block Device HBLQR



Mechanical Interlock SBMIQR



Molded Case Circuit Breakers

CQD 100A Frame

Selection/Dimensions

Type CQD (Cable In - Cable Out) DIN Rail Mount^③

Continuous Current Rating @ 40°C	1-Pole	2-Pole	3-Pole
	277V AC 125V DC	480Y/277V AC 125/250V DC	480Y/277V AC
	Catalog Number	Catalog Number	Catalog Number
15	CQD115 ^{①②}	CQD215 ^②	CQD315 ^②
20	CQD120 ^{①②}	CQD220 ^②	CQD320 ^②
25	CQD125 ^②	CQD225 ^②	CQD325 ^②
30	CQD130 ^②	CQD230 ^②	CQD330 ^②
35	CQD135 ^② ■	CQD235 ^② ■	CQD335 ^②
40	CQD140 ^② ■	CQD240 ^②	CQD340 ^②
45	CQD145 ^② ■	CQD245 ^② ■	CQD345 ^② ■
50	CQD150 ^② ■	CQD250 ^②	CQD350 ^②
60	CQD160■	CQD260	CQD360
70	CQD170■	CQD270	CQD370
80	CQD180■	CQD280	CQD380
90	CQD190■	CQD290■	CQD390
100	CQD1100■	CQD2100	CQD3100

Shipping Weights

Number of Poles	Number per Carton	Shipping Weight lbs. (kg)
1	1	0.5 (0)
2	1	1.0 (0)
3	1	1.5 (1)

Lugs For 60/75°C Wire

Amps	Wire Size
15-40	#14-#6 AWG Cu #12-#6 AWG Al
45-100	#8-#1 AWG Cu #6-#1/0 AWG Al

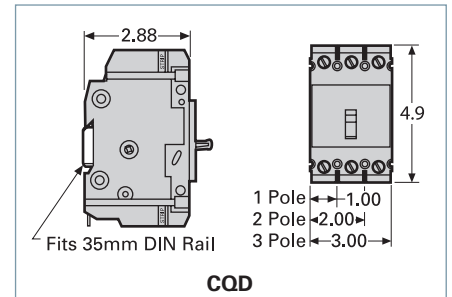
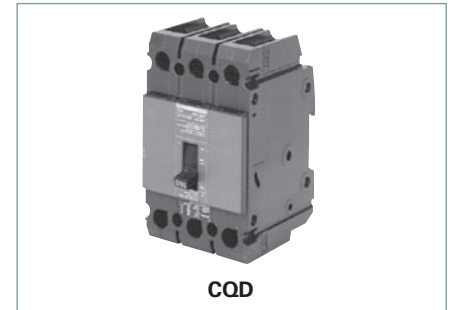

Interrupting Ratings (max. RMS symmetrical amperes kA)

Breaker Type	Number of Poles	UL						IEC 947-2 ^②				
		Volts AC						Volts AC				
								220/240		380/415		
		120	240	277	480/277	600/347	125/250	I _{cu}	I _{cs}	I _{cu}	I _{cs}	
CQD	1-Pole	65	—	14	—	—	14	—	18	9	—	—
	2-Pole	—	65	—	14	—	—	14	65	33	18	9
	3-Pole	—	65	—	14	—	—	14	65	33	18	9

For inches / millimeters conversion, see Application Data section.

■ Built to order. Allow 2-3 weeks for delivery.

① SWD rated.

Note: CQD breakers are UL Listed for reverse feed applications.

② HID rated.

③ HACR rated.

④ Applicable for 15-30A breakers only.

Enclosures Section 6
Accessories pages 7-42 and 7-94 to 7-99

Molded Case Circuit Breakers

GG 125A Frame

Selection/Dimensions

Type NGG (Cable In - Cable Out)

Continuous Current Rating @ 40°C	1-Pole	2-Pole	3-Pole
	Catalog Number	Catalog Number	Catalog Number
15	NGG1B015L ^{①②}	NGG2B015L ^②	NGG3B015L ^②
20	NGG1B020L ^{①②}	NGG2B020L ^②	NGG3B020L ^②
25	NGG1B025L ^②	NGG2B025L ^②	NGG3B025L ^②
30	NGG1B030L ^②	NGG2B030L ^②	NGG3B030L ^②
35	NGG1B035L ^②	NGG2B035L ^②	NGG3B035L ^②
40	NGG1B040L ^②	NGG2B040L ^②	NGG3B040L ^②
45	NGG1B045L ^②	NGG2B045L ^②	NGG3B045L ^②
50	NGG1B050L ^②	NGG2B050L ^②	NGG3B050L ^②
60	NGG1B060L	NGG2B060L	NGG3B060L
70	NGG1B070L	NGG2B070L	NGG3B070L
80	NGG1B080L	NGG2B080L	NGG3B080L
90	NGG1B090L	NGG2B090L	NGG3B090L
100	NGG1B100L	NGG2B100L	NGG3B100L
110	NGG1B110L	NGG2B110L	NGG3B110L
125	NGG1B125L	NGG2B125L	NGG3B125L

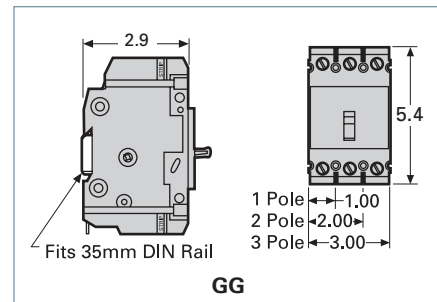

Line and load lugs are included as standard. If no lugs are required, remove the "L" suffix. HACR rated.

Suitable for screws or DIN rail mounting.

Type HGG (Cable In - Cable Out)

Continuous Current Rating @ 40°C	1-Pole	2-Pole	3-Pole
	Catalog Number	Catalog Number	Catalog Number
15	HGG1B015L ^{①②}	HGG2B015L ^②	HGG3B015L ^②
20	HGG1B020L ^{①②}	HGG2B020L ^②	HGG3B020L ^②
25	HGG1B025L ^②	HGG2B025L ^②	HGG3B025L ^②
30	HGG1B030L ^②	HGG2B030L ^②	HGG3B030L ^②
35	HGG1B035L ^②	HGG2B035L ^②	HGG3B035L ^②
40	HGG1B040L ^②	HGG2B040L ^②	HGG3B040L ^②
45	HGG1B045L ^②	HGG2B045L ^②	HGG3B045L ^②
50	HGG1B050L ^②	HGG2B050L ^②	HGG3B050L ^②
60	HGG1B060L	HGG2B060L	HGG3B060L
70	HGG1B070L	HGG2B070L	HGG3B070L
80	HGG1B080L	HGG2B080L	HGG3B080L
90	HGG1B090L	HGG2B090L	HGG3B090L
100	HGG1B100L	HGG2B100L	HGG3B100L
110	HGG1B110L	HGG2B110L	HGG3B110L
125	HGG1B125L	HGG2B125L	HGG3B125L

Type LGG (Cable In - Cable Out)

Continuous Current Rating @ 40°C	1-Pole	2-Pole	3-Pole
	Catalog Number	Catalog Number	Catalog Number
15	LGG1B015L ^{①②}	LGG2B015L ^②	LGG3B015L ^②
20	LGG1B020L ^{①②}	LGG2B020L ^②	LGG3B020L ^②
25	LGG1B025L ^②	LGG2B025L ^②	LGG3B025L ^②
30	LGG1B030L ^②	LGG2B030L ^②	LGG3B030L ^②
35	LGG1B035L ^②	LGG2B035L ^②	LGG3B035L ^②
40	LGG1B040L ^②	LGG2B040L ^②	LGG3B040L ^②
45	LGG1B045L ^②	LGG2B045L ^②	LGG3B045L ^②
50	LGG1B050L ^②	LGG2B050L ^②	LGG3B050L ^②
60	LGG1B060L	LGG2B060L	LGG3B060L
70	LGG1B070L	LGG2B070L	LGG3B070L
80	LGG1B080L	LGG2B080L	LGG3B080L
90	LGG1B090L	LGG2B090L	LGG3B090L
100	LGG1B100L	LGG2B100L	LGG3B100L
110	LGG1B110L	LGG2B110L	LGG3B110L
125	LGG1B125L	LGG2B125L	LGG3B125L

Shipping Weights

Number of Poles	Number per Carton	Shipping Weight lbs. (kg)
1	1	.75 (0.34)
2	1	1.3 (0.59)
3	1	2.0 (0.98)

Lugs For 60/75°C Wire

NGG		
Ampere Rating	Wire Size	Catalog Number
15-30A	#14-#6 AWG Cu	TC1Q1 (qty. 1)
	#12-#6 AWG Al	3TC1Q1 (qty. 3)
35-125A	#8-1/0 AWG Cu #8-2/0 AWG Al	3TC1GG20 (qty. 3)
15-125A	Nut Keeper plate w/ screw (for crimp terminals)	TNKG3 (qty. 3)

Interrupting Ratings (max. RMS symmetrical amperes kA)

Breaker Type	Poles	UL489 Volts AC							IEC 60947-2 (Ics = 50%Icu)				
									Volts DC		Volts AC		Volts DC
		120	240	277	347	480	600Y/347	125	125/250	240	415	125/250	
NGG	1	65	—	25	14	—	—	14	—	25	—	—	
	2,3	—	65	—	—	25	14	—	14 ^①	65	—	14	
HGG	1	65	—	35	22	—	—	14	—	—	—	—	
	2,3	—	65	—	—	35	22	—	14 ^①	—	—	—	
LGG	1	65	—	65	25	—	—	14	—	—	—	—	
	2,3	—	65	—	—	65	25	—	14 ^①	—	—	—	

For inches / millimeters conversion, see Application Data section.

① SWD rated.

② HID rated at 15-50A 1-pole @ 277 VAC; 2 & 3-pole @ 480 VAC

Enclosures Section 6
Accessories pages 7-42 and 7-94 to 7-99

Molded Case Circuit Breakers

Accessories^①

Selection

Shunt Trip

Control Voltage		BQD, BQD6, CQD, NGG, HGG, LGG, NGB, HGB and LGB Catalog Number
V AC	V DC	
120	—	CQDST120
240	—	CQDST240▲
277	—	CQDST277▲
480	—	CQDST480▲
600	—	CQDST600
—	12	CQDST12
—	24	CQDST24
—	48	CQDST48
—	125	CQDST125



Auxiliary Switch

Maximum Voltage		Number of Contacts	BQD, BQD6, CQD, NGG, HGG, LGG, NGB, HGB and LGB Catalog Number
AC	DC		
240	125	1A-1B	CQDA1
240	125	2A-2B	CQDA2

Alarm Switch

Maximum Voltage		BQD, BQD6, CQD, NGG, HGG, LGG, NGB, HGB and LGB Catalog Number
AC	DC	
240	125	CQDBA

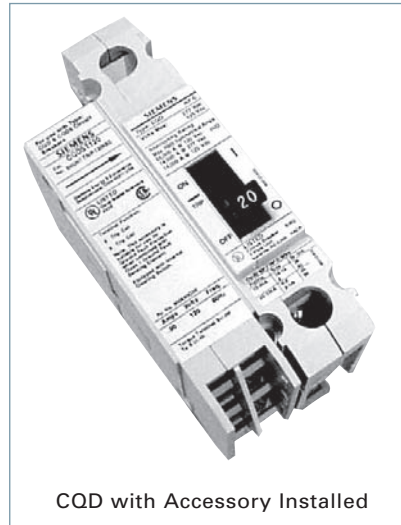

Shunt Trip and Auxiliary Switch Combinations

Shunt Trip Voltage		BQD, BQD6, CQD, NGG, HGG, LGG, NGB, HGB and LGB Catalog Number
AC	DC	
24	—	CQDST24AAS▲
120	—	CQDST120AAS▲
240	—	CQDST240AAS▲
277	—	CQDST277AAS▲
480	—	CQDST480AAS▲
600	—	CQDST600AAS▲
—	12	CQDST12DAS▲
—	24	CQDST24DAS▲
—	48	CQDST48DAS▲
—	125	CQDST125DAS▲

Alarm and Auxiliary Switch Combinations

For Breaker	Catalog Number
BQD, BQD6, CQD, NGG, HGG, LGG, NGB, HGB and LGB	CQDA1BA▲

▲ Built to order. Allow 6-8 weeks for delivery.

① Adds 1-pole space for accessory.

Molded Case Circuit Breakers

EG 125A Frame

Selection/Dimensions

Type NEG (Cable In - Cable Out)

Continuous Ampere Rating @ 40°C	1-Pole	2-Pole	3-Pole	4-Pole
	Catalog Number	Catalog Number	Catalog Number	Catalog Number
15	NEG1B015L ^{①②}	NEG2B015L ^②	NEG3B015L	NEG4B015L
20	NEG1B020L ^{①②}	NEG2B020L ^②	NEG3B020L	NEG4B020L
25	NEG1B025L ^②	NEG2B025L ^②	NEG3B025L	NEG4B025L
30	NEG1B030L ^②	NEG2B030L ^②	NEG3B030L	NEG4B030L
35	NEG1B035L ^②	NEG2B035L ^②	NEG3B035L	NEG4B035L
40	NEG1B040L ^②	NEG2B040L ^②	NEG3B040L	NEG4B040L
45	NEG1B045L ^②	NEG2B045L ^②	NEG3B045L	NEG4B045L
50	NEG1B050L ^②	NEG2B050L ^②	NEG3B050L	NEG4B050L
60	NEG1B060L	NEG2B060L	NEG3B060L	NEG4B060L
70	NEG1B070L	NEG2B070L	NEG3B070L	NEG4B070L
80	NEG1B080L	NEG2B080L	NEG3B080L	NEG4B080L
90	NEG1B090L	NEG2B090L	NEG3B090L	NEG4B090L
100	NEG1B100L	NEG2B100L	NEG3B100L	NEG4B100L
110	NEG1B110L	NEG2B110L	NEG3B110L	NEG4B110L
125	NEG1B125L	NEG2B125L	NEG3B125L	NEG4B125L

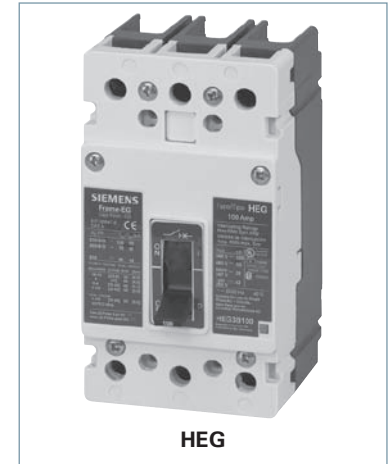

Type HEG (Cable In - Cable Out)

Continuous Ampere Rating @ 40°C	1-Pole	2-Pole	3-Pole	4-Pole
	Catalog Number	Catalog Number	Catalog Number	Catalog Number
15	HEG1B015L ^{①②}	HEG2B015L ^②	HEG3B015L	HEG4B015L
20	HEG1B020L ^{①②}	HEG2B020L ^②	HEG3B020L	HEG4B020L
25	HEG1B025L ^②	HEG2B025L ^②	HEG3B025L	HEG4B025L
30	HEG1B030L ^②	HEG2B030L ^②	HEG3B030L	HEG4B030L
35	HEG1B035L ^②	HEG2B035L ^②	HEG3B035L	HEG4B035L
40	HEG1B040L ^②	HEG2B040L ^②	HEG3B040L	HEG4B040L
45	HEG1B045L ^②	HEG2B045L ^②	HEG3B045L	HEG4B045L
50	HEG1B050L ^②	HEG2B050L ^②	HEG3B050L	HEG4B050L
60	HEG1B060L	HEG2B060L	HEG3B060L	HEG4B060L
70	HEG1B070L	HEG2B070L	HEG3B070L	HEG4B070L
80	HEG1B080L	HEG2B080L	HEG3B080L	HEG4B080L
90	HEG1B090L	HEG2B090L	HEG3B090L	HEG4B090L
100	HEG1B100L	HEG2B100L	HEG3B100L	HEG4B100L
110	HEG1B110L	HEG2B110L	HEG3B110L	HEG4B110L
125	HEG1B125L	HEG2B125L	HEG3B125L	HEG4B125L

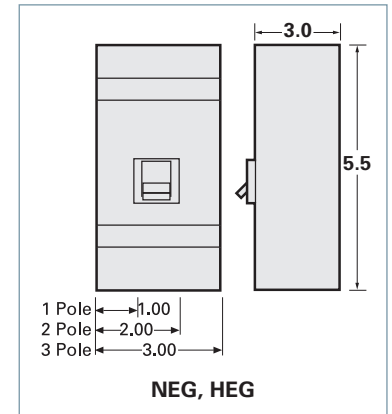

Line and load lugs are included as standard.
HACR rated.
Suitable for screw mounting.

Shipping Weights

Number of Poles	Number per Carton	Shipping Weight lbs. (kg)
1	1	1.1 (0.5)
2	1	2.0 (0.9)
3	1	3.1 (1.4)
4	1	3.9 (1.8)

Lugs For 60/75°C Wire

NEG/HEG		
Ampere Rating	Wire Size	Catalog Number
15-125A	#14 - 3/0 AWG Cu (steel lugs)	3TW1EG30 (qty. 3)
15-125A ^②	#14 - 1/0 AWG Cu #14 - 1/0 AWG Al	3TA1EG10 (qty. 3)
15-125A ^②	#6 - 3/0 AWG Cu #6 - 3/0 AWG Al	3TA1EG30 (qty. 3)
15-125A	Nut Keeper plate w/ screw (for crimp terminals)	TNKE3 (3-Pole) TNKE4 (4-Pole)

Interrupting Ratings

Breaker Type	Number of Poles	UL 489 AIR						IEC 60947-2						
		RMS Symmetrical Amperes (KA)						Volts AC (50/60Hz)						
		Volts AC(50/60Hz)			Volts DC			220/240		380/415		Volts DC		
NEG	1	85	35	22	—	—	35	—	85	43	—	—	35	—
	2, 3, 4	85	—	—	35	22 ^③	—	35	85	43	40	20	—	35
HEG	1	100	65	25	—	—	42	—	100	50	—	—	42	—
	2, 3, 4	100	—	—	65	25 ^③	—	42	100	50	70	35	—	42

For inches / millimeters conversion, see Application Data section.

① SWD rated.
② HID rated 277 VAC.

③ Applies to 3 & 4-pole breakers only.
④ Optional lugs for NEG and HEG breakers.

Accessories pages 7-44 and 7-94 to 7-99

Molded Case Circuit Breakers

Internal Accessories for NEG and HEG 125A Frame

Selection

Shunt Trip

Control Voltage		NEG, HEG, NEB, HEB Catalog Number
V AC	V DC	
110-240	—	STRER240A
—	125	STRED125D
380-600	—	STREV600
24-60	24-60	STREM60D

Auxiliary Switch

Maximum Voltage		Number of Contacts	NEG, HEG, NEB, HEB Catalog Number
AC	DC		
240	125	1A-1B	ASKE2
240	125	2A-2B	ASKE3

Alarm Switch

Maximum Voltage		Number of Contacts	NEG, HEG, NEB, HEB Catalog Number
AC	DC		
240	125	1A-1B	ASKE1
240	125	2A-2B	ASKE5

Undervoltage Trip

Control Voltage		NEG, HEG, NEB, HEB Catalog Number
AC	DC	
24		UVREB24A
60		UVREM60▲
120		UVREN120
240		UVRER240
480		UVREU480▲
600		UVREV600▲
	24	UVREB24D
	48	UVREC48D▲
	125	UVRED125D▲
	250	UVREE250D▲

Alarm and Auxiliary Switch Combinations

For Breaker	Catalog Number
NEG, HEG	ASKE6

▲ Built to order. Allow 6-8 weeks for delivery.

Molded Case Circuit Breakers

ED 125A Frame Sentron Series

Selection

Ordering Instructions

- All ED Frame Sentron circuit breakers are supplied with load side lugs. If line side lugs are required, add "L" suffix to catalog number. Consult Siemens sales office for any additional charge
- 50°C Calibration, 400HZ - see page 7-90. All ED frame circuit breakers may be reverse connected

Type ED2^⑤

Blue Label

Continuous Current Rating @ 40°C	1-Pole		2-Pole		3-Pole
	120V AC	125V DC	240V AC	125V DC 250V DC	240V AC
	Catalog Number		Catalog Number		Catalog Number
15	ED21B015 ^④ ■	—	ED22B015	—	ED23B015
20	ED21B020 ^④ ■	—	ED22B020	—	ED23B020
25	ED21B025■	—	ED22B025■	—	ED23B025■
30	ED21B030■	—	ED22B030	—	ED23B030
35	ED21B035■	—	ED22B035■	—	ED23B035■
40	ED21B040■	—	ED22B040	—	ED23B040
45	ED21B045■	—	ED22B045■	—	ED23B045■
50	ED21B050■	—	ED22B050	—	ED23B050
60	ED21B060■	—	ED22B060	—	ED23B060
70	ED21B070■	—	ED22B070	—	ED23B070
80	ED21B080■	—	ED22B080■	—	ED23B080
90	ED21B090■	—	ED22B090■	—	ED23B090■
100	ED21B100■	—	ED22B100	—	ED23B100

Shipping Weights

Number of Poles	Number per Carton	Shipping Weight (lbs.)
ED2, ED4, ED6, HED4, HHED6		
1	30	38
2	10	25
3	10	38
CED6		
2	5	20
3	5	30

Lugs

Ampere Rating	No. of Poles	Catalog Number	Wire Range
Aluminum Body Lugs			
All 15–25A	1, 2, 3	Line/Load SA1E025	#14–#10 Cu #12–#10 Al
All 30–100A	1, 2, 3	Line Side LN1E100	#10–1/0 Cu/Al
ED2, 4, CED6 30–60A	1	Load Side LD1E060	#10–#4 Cu/Al
ED2, 4, CED6 70–100A	1	Load Side LD1E100	#6–#1/0 Cu/Al
ED2, 4, HED4, HHED6 30–100A	2, 3	Load Side LN1E100	#10–1/0 Cu/Al
ED6 20–50A	2, 3	Line Side LN1E100	#10–1/0 Cu/Al
All 110, 125A	2, 3	Line/Load TA1E6125	#3–3/0 Cu #1–2/0 Al
Copper Body Lugs			
All 30–125A	1, 2, 3	Line/Load TC1E6150 ^③	#10–1/0 Cu only
Compression Lugs			
All ED, HHED, CED		CCE125	2/0

Type ED4^⑤

Blue Label

Continuous Current Rating @ 40°C	1-Pole		2-Pole		3-Pole
	120V AC	125V DC	480V AC	250V DC	480V AC
	Catalog Number		Catalog Number		Catalog Number
15	ED41B015 ^④	—	—	—	ED43B015
20	ED41B020 ^④	—	ED42B020	—	ED43B020
25	ED41B025	—	ED42B025	—	ED43B025
30	ED41B030	—	ED42B030	—	ED43B030
35	ED41B035■	—	ED42B035■	—	ED43B035
40	ED41B040	—	ED42B040	—	ED43B040
45	ED41B045■	—	ED42B045■	—	ED43B045
50	ED41B050	—	ED42B050	—	ED43B050
60	ED41B060	—	ED42B060	—	ED43B060
70	ED41B070	—	ED42B070	—	ED43B070
80	ED41B080■	—	ED42B080■	—	ED43B080
90	ED41B090■	—	ED42B090■	—	ED43B090
100	ED41B100	—	ED42B100	—	ED43B100
110	ED41B110	—	ED42B110■	—	ED43B110
125	—	—	ED42B125	—	ED43B125

Enclosures (Neutral Included)^⑥

Type	Catalog Number
1 (Surface)	E2N1S (15–100A)
1 (Flush)	E2N1F (15–100A)
3R	E2N3R (15–100A)
4–4X	ED6SS4 (15–125A)
4–4X	ED6S4 (15–100A)
4–4X (316SS)	ED6S4316 (15–100A)
7–9	EA (15–60A)
7–9	EB (70–100A)
12	E2N12 (15–100A)
1 (Surface)	CED6N1S ^②
1 (Flush)	CED6N1F ^②
3R	CED6N3R ^②
12	CED6N12 ^②

Type ED6^⑤

Blue Label

Continuous Current Rating @ 40°C	1-Pole ^①		2-Pole		3-Pole		3-Pole
	347V AC		600V AC	250V DC	600V AC	500V DC	600V DC
	Catalog Number		Catalog Number		Catalog Number		Catalog Number
15	ED61B015	—	—	—	—	—	ED63D015L
20	ED61B020	—	ED62B020	—	—	—	ED63D020L
25	ED61B025	—	ED62B025■	—	—	—	ED63D025L
30	ED61B030	—	ED62B030	—	—	—	ED63D030L
35	ED61B035	—	—	—	—	—	ED63D035L
40	ED61B040	—	—	—	—	—	ED63D040L
45	ED61B045■	—	—	—	—	—	ED63D045L
50	ED61B050	—	—	—	—	—	ED63D050L
60	ED61B060	—	—	—	—	—	ED63D060L
70	ED61B070■	—	—	—	—	—	ED63B070
80	ED61B080	—	—	—	—	—	ED63B080
90	ED61B090	—	—	—	—	—	ED63B090
100	ED61B100■	—	—	—	—	—	ED63B100
110	—	—	—	—	—	—	ED63B110
125	—	—	—	—	—	—	ED63B125

Note: ED frame circuit breakers qualified to UL 489 Supplement SB "Naval"— See page 7-90 for additional information

- Built to order. Allow 2–3 weeks for delivery.
- ① CSA Certified only (Not UL)

② For CED types and all 110–125 ampere ED frames.

③ See Note: A, page 7-87.

④ SWD rated.

⑤ HACR rated.

⑥ Not for use with HHED6 breakers.

Modifications page 7-90
Enclosures Section 6
Accessories pages 7-47 and 7-94 to 7-99

Molded Case Circuit Breakers

ED 125A Frame Sentron Series

Selection/Dimensions

Type HED4⁵

Black Label

Continuous Current Rating @ 40°C	1-Pole		2-Pole		3-Pole
	277V AC	125V DC	480V AC	250V DC	480V AC
	Catalog Number		Catalog Number		Catalog Number
15	HED41B015 ^①		HED42B015		HED43B015
20	HED41B020 ^①		HED42B020		HED43B020
25	HED41B025		HED42B025■		HED43B025
30	HED41B030		HED42B030		HED43B030
35	HED41B035■		HED42B035■		HED43B035
40	HED41B040		HED42B040		HED43B040
45	HED41B045■		HED42B045■		HED43B045
50	HED41B050■		HED42B050		HED43B050
60	HED41B060■		HED42B060■		HED43B060
70	HED41B070■		HED42B070■		HED43B070
80	HED41B080■		HED42B080■		HED43B080
90	HED41B090■		HED42B090■		HED43B090
100	HED41B100■		HED42B100■		HED43B100
110	—		HED42B110■		HED43B110
125	—		HED42B125■		HED43B125

FIGURE 1 - ED, HED, HHED

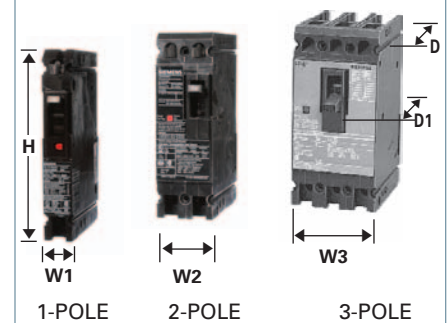
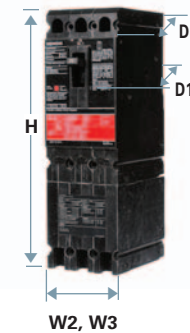

FIGURE 2 - CED (3-Pole shown)



Dimensions (in inches)

Breaker Type	W1	W2	W3	H	D	D1
Figure 1 ED2, ED4, ED6, HED4, ED6 ETI ^③	1	2	3	6.35	3.92	4.56
Figure 1 HHED6	—	2	3	6.53	3.92	4.56
Figure 2 CED6, CED6 ETI ^③	—	2	3	9.58	3.92	4.56

Fuseless Current Limiting

Type HHED6⁵

Black Label

Type CED6⁵

Red Label

Continuous Current Rating @ 40°C	3-Pole		2-Pole	3-Pole
	600V AC		600V AC, 250V DC	600V AC, 500V DC ^②
	Catalog Number ^④		Catalog Number	Catalog Number
15	HHED63B015A		CED62B015	CED63B015
20	HHED63B020		CED62B020■	CED63B020
25	HHED63B025		—	—
30	HHED63B030		CED62B030■	CED63B030
35	HHED63B035		—	—
40	HHED63B040		—	CED63B040
45	HHED63B045		—	—
50	HHED63B050		—	CED63B050
60	—		CED62B060■	CED63B060
70	—		CED62B070■	CED63B070
80	—		CED62B080■	CED63B080
90	—		CED62B090■	CED63B090
100	—		CED62B100■	CED63B100
110	—		—	CED63B110■
125	—		CED62B125■	CED63B125

Interrupting Ratings

Breaker Type	UL 489 AIR (File #E10848)									IEC 947-2						
	RMS Symmetrical Amperes (KA)															
	Volts AC						Volts DC			220/240			380/415		500	
	120	240	277	347	480	600	125	250	500 ^②	600	Icu	Ics	Icu	Ics	Icu	Ics
ED2 (1-P)	10	—	—	—	—	—	5	—	—	—	—	—	—	—	—	—
ED2 (2, 3-P)	—	10	—	—	—	—	—	5 (2-P)	—	—	—	—	—	—	—	—
ED4 (1-P)	65	—	22	—	—	—	30	—	—	—	—	—	—	—	—	—
ED4 (2, 3-P)	—	65	—	—	18	—	—	30 (2-P)	—	—	—	—	—	—	—	—
ED6 (1P)	—	—	—	30 ^④	—	—	—	30	—	—	—	—	—	—	—	—
ED6 (2, 3-P)	—	65	—	—	25	18	—	—	18 (3-P)	65	17	35	9	18	5	
ED6 (3-P)	—	—	—	—	—	—	—	—	10	—	—	—	—	—	—	
HED4 (1-P) (15-30A)	100	—	65	—	—	—	30	—	—	—	—	—	—	—	—	
HED4 (1-P) (35-100A)	100	—	25	—	—	—	30	—	—	—	—	—	—	—	—	
HED4 (2, 3-P)	—	100	—	—	42	—	—	30 (2-P)	—	—	—	—	—	—	—	
HHED6 (2, 3-P)	—	100	—	—	65	18 ^④	—	—	—	—	—	—	—	—	—	
CED6 (2, 3-P)	—	200	—	—	200	100	—	50 (2-P)	30 (3-P)	—	—	—	—	—	—	

■ Built to order. Allow 2-3 weeks for delivery.

①SWD rated.

②When wired as shown on page 7-4, this circuit breaker is UL listed and rated for use on 500V DC ungrounded UPS systems.

③ ED6-ETI, CED6-ETI, see page 7-74 for ordering information.

④ Single Pole 15-30A 30KA @ 347V non-UL. 35-100A 18KA @ 347V non-UL.

⑤ HACR rated.

⑥ HHED63B015A is rated 18KAIC at 600/347V.

Molded Case Circuit Breakers

Accessories for:

ED 125A Frame



Combinations

Available only when ordered together. Only one module can be added to a breaker. Additional accessories, which always attach to the left pole, cannot be added to the combination later. Adds 1 inch pole space.

Equipment Ground Sensing

A field addable kit containing 30mA or 5 mA ground fault accessory module, current transformer with 24 inch leads, and current transformer mounting equipment. Current transformer to mount in gutter of lighting panel or any control panel. Accessory module operates from separate 120V control power source.

Both 30MA and 5MA devices are equipment protection devices only. Do not use for personnel protection.



Shunt Trip Combinations

Control Voltage		1 Shunt Trip	1 Shunt Trip and 1 Auxiliary Switch	1 Shunt Trip and 1 Auxiliary Switch and 1 Alarm Switch	1 Shunt Trip and 1 Alarm Switch	1 Shunt Trip and 2 Auxiliary Switches
AC	DC	Catalog Number	Catalog Number	Catalog Number	Catalog Number	Catalog Number
24		S17ED60	—	—	—	—
48		S18ED60	—	—	—	—
120		S01ED60	S01ED62A	S01ED62AB	S01ED62B	S01ED62AA
208		—	S02ED62A▲	S02ED62AB▲	S02ED62B▲	S02ED62AA▲
240		S03ED60	S03ED62A	S03ED62AB	S03ED62B▲	S03ED62AA▲
277		S15ED60▲	S15ED64A▲	S15ED64AB▲	S15ED64B▲	—
480		S04ED60	S04ED64A▲	S04ED64AB▲	S04ED64B▲	—
	12	S16ED60▲	S16ED62A▲	—	—	—
	24	S07ED60	S07ED62A	S07ED62AB▲	S07ED62B▲	S07ED62AA▲
	48	S09ED60▲	S09ED62A▲	S09ED62AB▲	S09ED62B▲	S09ED62AA▲
	125	S11ED60▲	S11ED62A▲	S11ED62AB▲	S11ED62B▲	S11ED62AA▲
	250	S13ED60▲	S13ED62A▲	S13ED62AB▲	S13ED62B▲	S13ED62AA▲

Undervoltage Trip Combinations

Control Voltage		1 Undervoltage Trip	1 Undervoltage Trip and 1 Auxiliary Switch	1 Undervoltage Trip and 1 Auxiliary Switch and 1 Alarm Switch	1 Undervoltage Trip and 1 Alarm Switch	1 Undervoltage Trip and 2 Auxiliary Switches
AC	DC	Catalog Number	Catalog Number	Catalog Number	Catalog Number	Catalog Number
120		U01ED60	U01ED62A	U01ED62AB▲	U01ED62B▲	U01ED62AA▲
208		U02ED60▲	U02ED62A▲	U02ED62AB▲	U02ED62B▲	U02ED62AA▲
240		U03ED60	U03ED62A▲	U03ED62AB▲	U03ED62B▲	U03ED62AA▲
277		U16ED60▲	U16ED64A▲	U16ED64AB▲	U16ED64B▲	—
480		U06ED60▲	U06ED64A▲	U06ED64AB▲	U06ED64B▲	—
600		U08ED60▲	—	—	—	—
	24	U13ED60	U13ED62A▲	U13ED62AB▲	U13ED62B▲	U13ED62AA▲
	48	U14ED60▲	U14ED62A▲	U14ED62AB▲	U14ED62B▲	U14ED62AA▲
	125	U10ED60▲	U10ED62A▲	U10ED62AB▲	U10ED62B▲	U10ED62AA▲
	250	U12ED60▲	U12ED62A▲	—	—	U12ED62AA▲

Auxiliary Switch Combinations

Maximum Voltage		1 Auxiliary Switch	1 Alarm Switch and 1 Auxiliary Switch	2 Auxiliary Switches	1 Alarm Switch and 2 Auxiliary Switches
AC	DC	Catalog Number	Catalog Number	Catalog Number	Catalog Number
240	250	A01ED62	A01ED62B	A02ED62	A02ED62B
480		A01ED64	A01ED64B	—	—

Maximum Voltage		1 Auxiliary Switch	
AC	DC	Catalog Number	
	12	A01EDLV	Gold Plated Contacts—for PLC use

Alarm Switch Only

Maximum Voltage		1 Alarm Switch	
AC	DC	Catalog Number	
240	250	B00ED62	
480		B00ED64	

Ground Fault Sensing Relay Kit — Equipment Protection Only

For Use With Breaker Frame	Number of Poles	Description	Catalog Number	
			30mA	5mA
CED6, ED2, ED4 ED6, EFC, EFF, HED4, HHED6	1, 2, 3	Basic Kit	GF01ED60	GF01ED65
		Basic Kit with Normally Open Bell Alarm	GF01ED60B0	GF01ED65B0▲
		Basic Kit with Normally Closed Bell Alarm	GF01ED60BC	GF01ED65BC▲

▲ Built to order. Allow 6–8 weeks for delivery.

Molded Case Circuit Breakers

FD 250A Frame Sentron Series

Selection

Type FXD6-A^{①⑥}

Blue Label

Non-Interchangeable Trip (Assembled Circuit Breaker – Without Lugs)		
Continuous Current Rating @ 40°C	2-Pole	3-Pole
	Catalog Number	Catalog Number
70	FXD62B070■	FXD63B070
80	FXD62B080■	FXD63B080
90	FXD62B090■	FXD63B090
100	FXD62B100	FXD63B100
110	FXD62B110■	FXD63B110
125	FXD62B125	FXD63B125
150	FXD62B150	FXD63B150
175	FXD62B175	FXD63B175
200	FXD62B200	FXD63B200
225	FXD62B225	FXD63B225
250	FXD62B250	FXD63B250

Type FD6-A^⑥

Blue Label

Interchangeable Trip			
Continuous Current Rating @ 40°C	Complete Breaker Unassembled w/Lugs	Frame Only	Trip Unit Only
	Catalog Number	Catalog Number	Catalog Number

2-Pole 600V AC, 250V DC^②

70	FD62B070■	FD62F250	FD62T070■
80	FD62B080■		FD62T080■
90	FD62B090■		FD62T090■
100	FD62B100■		FD62T100■
110	FD62B110■		FD62T110■
125	FD62B125■		FD62T125■
150	FD62B150		FD62T150
175	FD62B175■		FD62T175■
200	FD62B200		FD62T200
225	FD62B225■		FD62T225■
250	FD62B250■		FD62T250■

3-Pole 600V AC, 500V DC^③

70	FD63B070■	FD63F250	FD63T070■
80	FD63B080■		FD63T080■
90	FD63B090■		FD63T090■
100	FD63B100		FD63T100
110	FD63B110■		FD63T110■
125	FD63B125		FD63T125
150	FD63B150		FD63T150
175	FD63B175		FD63T175
200	FD63B200		FD63T200
225	FD63B225		FD63T225
250	FD63B250		FD63T250

Interrupting Ratings

Breaker Type	RMS Symmetrical Amperes (KA)									
	UL 489 AIR (File E10848)						IEC 947-2 ^⑦			
	Volts AC (50/60Hz)			Volts DC		Volts AC (50/60Hz)				
	240	480	600	250	500 ^③	220/240	380/415	500		
						lcu	lcs	lcu	lcs	
FXD6-A, FD6-A	65	35	22	30 (2-P)	18 (3-P)	65	33	35	18	—
HFXD6, HFD6	100	65	25	30 (2-P)	25 (3-P)	100	50	65	33	—
HHFD6, HHFXD6	200	100	25	—	—	—	—	—	—	—
CFD6	200	200	100	30 (2-P)	50 (3-P)	—	—	—	—	—

Instantaneous Adjustment Trip Range

Breaker Ampere Rating	Nominal Instantaneous Values							±20% Tolerance High
	±20% Tolerance Low	2	3	4	5	6	7	
70-90	600	640	690	730	770	810	850	900
100-110	700	770	840	920	990	1060	1140	1200
125-150	800	900	1000	1100	1200	1300	1400	1500
175-200	900	1060	1210	1370	1520	1780	1930	2000
225-250	1100	1300	1500	1700	1900	2100	2300	2500

Note: FD frame qualified to UL489 supplement SB "NAVAL". See page 7-90 for additional information.

Ordering Information

Complete Breaker Unassembled with Lugs

Prices of FD6, HFD6, and HHFD6 breakers includes frame, trip and both line and load lugs (TA1FD350A). When ordered by these catalog numbers, the customer will receive the frame, trip, and lugs separately packaged. For applications requiring different lugs, order individual items as needed.

Complete Breaker Assembled with-out Lugs

Prices of FXD6, HFXD6, HHFXD6, and CFD6 includes frame with non-interchangeable trip unit installed only. Order required lugs separately. For line and load lugs (TA1FD350A) installed, add suffix "L" to catalog number (add 2 times list price of lugs for each pole).

50°C Applications see page 7-90.

400 Hz Applications see page 7-90.

Lugs For 75°C Wire^⑤

Catalog Number	Wire Range
TA1FD350A	#6–350 kcmil Cu #4–350 kcmil Al
TC1FD350	#6–350 kcmil Cu
Compression Lug	
CCF250	350 kcmil Cu/Al

Enclosures

Type	Catalog Number
1	F6N1S(F)
3R	F6N3R
4-4X	FD6SS4
7-9	EC2
12	F6N12
Neutral ^⑥	N250

Modifications page 7-90
Enclosures Section 6
Accessories pages 7-50 and 7-94 to 7-99

■ Built to order. Allow 2–3 weeks for delivery.

① Type FXD6-A circuit breakers are UL Listed for reverse fed applications.

② 2-pole units are 3-pole width.

③ When wired as shown on page 7-4, this circuit breaker is UL listed and rated for use on 500V DC ungrounded UPS systems only.

④ Order neutral as separate item.

⑤ See Note A, page 7-87.

⑥ HACR rated.

⑦ Only applicable to interchangeable trip unit types: FXD6A, HFXD6A.

Molded Case Circuit Breakers

FD 250A Frame Sentron Series

Selection/Dimensions

Type HFD6, Type HFXD6^{②③④⑤}

Black Label

Interchangeable Trip			
Continuous Current Rating @ 40°C	Complete Breaker Unassembled w/Lugs	Frame Only	Trip Unit Only
	Catalog Number	Catalog Number	Catalog Number

2-Pole 600V AC, 250V DC (3-Pole Width)

Current Rating	Complete Breaker Unassembled w/Lugs	Frame Only	Trip Unit Only
70	HFD62B070■	HFD62F250	FD62T070■
80	HFD62B080■		FD62T080■
90	HFD62B090■		FD62T090■
100	HFD62B100■		FD62T100■
110	HFD62B110■		FD62T110■
125	HFD62B125■		FD62T125■
150	HFD62B150■		FD62T150■
175	HFD62B175■		FD62T175■
200	HFD62B200■		FD62T200■
225	HFD62B225■		FD62T225■
250	HFD62B250■		FD62T250■

3-Pole 600V AC, 500V DC^①

Current Rating	Complete Breaker Unassembled w/Lugs	Frame Only	Trip Unit Only
70	HFD63B070■	HFD63F250	FD63T070■
80	HFD63B080■		FD63T080■
90	HFD63B090■		FD63T090■
100	HFD63B100■		FD63T100■
110	HFD63B110■		FD63T110■
125	HFD63B125■		FD63T125■
150	HFD63B150■		FD63T150■
175	HFD63B175■		FD63T175■
200	HFD63B200■		FD63T200■
225	HFD63B225■		FD63T225■
250	HFD63B250■		FD63T250■

Type HHFD, HHFXD6^{②③⑤}

3-Pole 600V AC, Extra High Interrupting

Current Rating	Complete Breaker Unassembled w/Lugs	Frame Only	Trip Unit Only
70	HHFD63B070■	HHFD63F250	FD63T070■
80	HHFD63B080■		FD63T080■
90	HHFD63B090■		FD63T090■
100	HHFD63B100■		FD63T100■
110	HHFD63B110■		FD63T110■
125	HHFD63B125■		FD63T125■
150	HHFD63B150■		FD63T150■
175	HHFD63B175■		FD63T175■
200	HHFD63B200■		FD63T200■
225	HHFD63B225■		FD63T225■
250	HHFD63B250■		FD63T250■

Type CFD6-A^{③⑤}

Fuseless Current Limiting

Red Label

Non-Interchangeable Trip (Assembled Circuit Breaker without Lugs)	
Continuous Current Rating @ 40°C	3-Pole 600V AC/500V DC
	Catalog Number
70	CFD63B070■
80	CFD63B080■
90	CFD63B090■
100	CFD63B100■
110	CFD63B110■
125	CFD63B125■
150	CFD63B150■
175	CFD63B175■
200	CFD63B200■
225	CFD63B225■
250	CFD63B250■

■ Built to order. Allow 2-3 weeks for delivery.

① When wired as shown on page 7-4, this circuit breaker is UL listed and rated for use on 500V DC ungrounded UPS systems.

② For non-interchangeable trip 3-pole HFD6 type circuit breaker, change prefix identifier from HFD6 to HFXD6.

Price equals frame and trip prices combined, e.g. price of HFXD63B250 equals price of HFD63F250 plus price of FD63T250. Order lugs separately.

③ Type HFXD6, HHFXD6, CFD6 are UL Listed for reverse feed applications.

④ FXD6, ETI, CFD6, ETI — See page 7-74 for ordering information.

⑤ HACR rated.

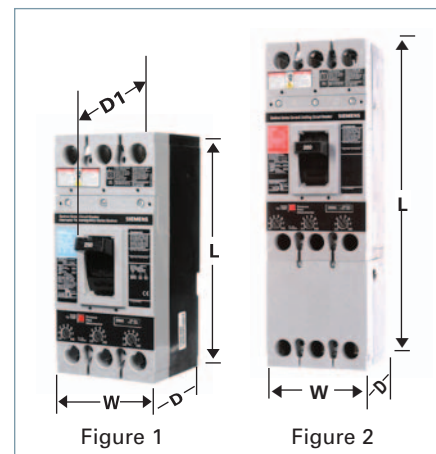

Dimensions (in inches)

Breaker Type	W	L	D	D1 (to handle)
Figure 1 FXD6-A, FD6-A, HFD6, HFXD6, HHFD6, FD6-ETI ^④	4.50	9.50	4	5.25
Figure 2 CFD6, CFD6-ETI ^④	4.50	14.25	4	5.25

Shipping Weights

Number of Poles	Number per Carton	Shipping Weight (lbs.)
FD6-A, HFD6, HHFD6, FXD6-A Assembled Circuit Breaker (less connectors)		
2	1	8.6
3	1	10
FD6-A, HFD6, HHFD6 Frame Only		
2	1	7.5
3	1	8.7
FD6 Trip Unit Only		
2	1	1.1
3	1	1.3
CFD6 Assembled Circuit Breaker (less terminals)		
3	1	16

7
MOLDED CASE
CIRCUIT BREAKERS

Molded Case Circuit Breakers

Accessories:
for FD, FFC & FFF 250A Frames



Shunt Trip Combinations

Control Voltage		1 Shunt Trip
AC	DC	Catalog Number
24		S17FD60
120		S01FD60
240		S03FD60
277		S15FD60▲
480		S04FD60
600		S06FD60▲
	12	S16FD60▲
	24	S07FD60
	48	S09FD60▲
	125	S11FD60
	250	S13FD60▲

Undervoltage Trip Combinations

Control Voltage		1 Undervoltage Trip	1 Undervoltage Trip and 1 Auxiliary Switch
AC	DC	Catalog Number	Catalog Number
120		U01FD60	W01FD64
208		U02FD60▲	W02FD64▲
240		U03FD60	W03FD64▲
277		U16FD60▲	W16FD64▲
480		U06FD60▲	W06FD64▲
600		U08FD60▲	—
	24	U13FD60	W13FD64
	48	U14FD60▲	W14FD64▲
	125	U10FD60▲	W10FD64▲
	250	U12FD60▲	W12FD64▲

Auxiliary Switch Combinations

Voltage		1 Auxiliary Switch	2 Auxiliary Switches
AC	DC	Catalog Number	Catalog Number
240		A01FD62	A02FD62
480		A01FD64	A02FD64
	12	A01FDLV	Gold Plated Contacts - for PLC use

Alarm Switch Combinations

Maximum Voltage		1 Alarm Switch	1 Alarm Switch and 1 Auxiliary Switch
AC	DC	Catalog Number	Catalog Number
480	250	B00FD64	C01FD64

▲ Built to order. Allow 6-8 weeks for delivery.

ⓄAuxiliary switch application is for 480V AC maximum.

Note: Old F-frame accessories cannot be used in new Sentron line. Likewise, new FD-frame accessories cannot be used on old F-frame circuit breakers.

Molded Case Circuit Breakers

JD 400A Frame Sentron Series

Selection

Type JXD2-A^④

240V AC, 2-Pole 250V DC Only

Blue Label

Non-Interchangeable Trip (Assembled Circuit Breaker without Lugs)		
Continuous Current Rating @ 40°C	2-Pole (3-Pole Width) Catalog Number	3-Pole Catalog Number
200	JXD22B200■	JXD23B200
225	JXD22B225■	JXD23B225
250	JXD22B250■	JXD23B250
300	JXD22B300	JXD23B300
350	JXD22B350■	JXD23B350
400	JXD22B400	JXD23B400

Type JXD6-A^{①④}

600V AC, 2-Pole 250V DC, 3-Pole 500V DC^②

Blue Label

Non-Interchangeable Trip (Assembled Circuit Breaker without Lugs)		
Continuous Current Rating @ 40°C	2-Pole (3-Pole Width) Catalog Number	3-Pole Catalog Number
200	JXD62B200■	JXD63B200
225	JXD62B225■	JXD63B225
250	JXD62B250■	JXD63B250
300	JXD62B300	JXD63B300
350	JXD62B350■	JXD63B350
400	JXD62B400	JXD63B400

Type JD6-A^④

Blue Label

Interchangeable Trip			
Continuous Current Rating @ 40°C	Complete Breaker Unassembled w/Lugs	Frame Only	Trip Unit Only
	Catalog Number	Catalog Number	Catalog Number

2-Pole 600V AC, 250V DC (3-Pole Width)

200	JD62B200■	JD62F400	JD62T200■
225	JD62B225■		JD62T225■
250	JD62B250■		JD62T250■
300	JD62B300■		JD62T300■
350	JD62B350■		JD62T350■
400	JD62B400		JD62T400

3-Pole 600V AC, 500V DC^②

200	JD63B200	JD63F400	JD63T200
225	JD63B225		JD63T225
250	JD63B250		JD63T250
300	JD63B300		JD63T300
350	JD63B350		JD63T350
400	JD63B400		JD63T400

Interrupting Ratings

Breaker Type	RMS Symmetrical Amperes (KA)									
	UL 489 AIR (File E10848)					IEC 947-2 ^⑤				
	Volts AC (50/60Hz)			Volts DC		Volts AC (50/60Hz)				
	240	480	600	250	500 ^②	220/240	380/415	500	lcs	lcs
JXD2-A	65	—	—	30 (2-P)	—	—	—	—	—	—
JXD6-A, JD6-A	65	35	25	30 (2-P)	25 (3-P)	65	33	40	20	—
HJD6-A, HJXD6-A	100	65	35	30 (2-P)	35 (3-P)	100	50	65	33	—
HHJD6, HHJXD6	200	100	50	—	—	—	—	—	—	—
CJD6-A	200	150	100	30 (2-P)	50 (3-P)	—	—	—	—	—

Instantaneous Adjustment Trip Range

Breaker Ampere Rating	Nominal Instantaneous Values							
	±20% Tolerance Low	2	3	4	5	6	7	±20% Tolerance High
200-300	1250	1430	1610	1790	1960	2140	2320	2500
350-400	2000	2290	2570	2860	3140	3430	3710	4000

■ Built to order. Allow 2-3 weeks for delivery.

①Type JXD2 and JXD6 circuit breakers are UL Listed for reverse feed applications.

②When wired as shown on page 7-4, this circuit breaker is UL listed and rated for use on 500V DC ungrounded UPS systems only.

③See Note: A, page 7-87.

④ HACR rated.

⑤ Only applicable to interchangeable trip unit types: JXD6-A, HJXD6-A.

Note: JD frame qualified to UL489 supplement B "NAVAL." See page 7-90 for additional information.

Ordering Information

Complete Breaker Unassembled with Lugs

Prices of JD6, HJD6, and HHJD6 breakers include frame, trip and both line and load lugs (TA2J6500). When ordered by these catalog numbers, the customer will receive the frame, trip, and lugs separately packaged. For applications requiring different lugs, order individual items as needed.

Complete Breaker Assembled with Lugs

Prices of JXD6, HJXD6, HHJXD6, and CJD6 include frame with non-interchangeable trip unit installed only. Order required lugs separately. For line and load lugs (TA2J6500) installed, add suffix "L" to catalog number (add 2 times list price of lugs for each pole).

100% Rated (3-pole only)

Types JXD6 and HJXD6 breakers are available with 100% ratings. To order add suffix "H" to catalog number, and 10% to list price. ■ 100% rated JD breakers require the use of 90°C Cu cable sized at 75°C ampacity and lugs TC1J6600 or TC2J6500.

50°C Applications see page 7-90.

400Hz Applications see page 7-90.

Lugs For 75°C Wire^③

Catalog Number	Cables per Lug	Wire Range
TA2J6500	1, 2	#3/0-500 kcmil Cu #4/0-500 kcmil Al
TA1L6750	1	500-750 kcmil Al 500-600 kcmil Cu
TC1J6600	1	#3/0-600 kcmil Cu
TC2J6500	1, 2	#3/0-500 kcmil Cu
Compression Lug		
CCL600	1	500 kcmil Cu/Al

7
MOLDED CASE
CIRCUIT BREAKERS

Modifications page 7-90
Enclosures Section 6
Accessories pages 7-54 and 7-94 to 7-99

Molded Case Circuit Breakers

JD 400A Frame Sentron Series

Selection/Dimensions

Type HJD6-A, HJXD6-A^{②④⑥}

Black Label

Interchangeable Trip			
Continuous Current Rating @ 40°C	Complete Breaker Unassembled w/Lugs	Frame Only	Trip Unit Only
	Catalog Number	Catalog Number	Catalog Number
2-Pole 600V AC, 250V DC (3-Pole Width)			
200	HJD62B200■	HJD62F400■	JD62T200■
225	HJD62B225■		JD62T225■
250	HJD62B250■		JD62T250■
300	HJD62B300■		JD62T300■
350	HJD62B350■		JD62T350■
400	HJD62B400■		JD62T400■

3-Pole 600V AC, 500V DC^{①②⑤}

200	HJD63B200■	HJD63F400	JD63T200
225	HJD63B225■		JD63T225
250	HJD63B250■		JD63T250
300	HJD63B300■		JD63T300
350	HJD63B350■		JD63T350
400	HJD63B400■		JD63T400

Type HHJD6, HHJXD6^{②④⑥}

Black Label

Interchangeable Trip			
Continuous Current Rating @ 40°C	Complete Breaker Unassembled w/Lugs	Frame Only	Trip Unit Only
	Catalog Number	Catalog Number	Catalog Number
2-Pole 600V AC (3-Pole Width)			
200	HHJD62B200■	HHJD62F400■	JD62T200■
225	HHJD62B225■		JD62T225■
250	HHJD62B250■		JD62T250■
300	HHJD62B300■		JD62T300■
350	HHJD62B350■		JD62T350■
400	HHJD62B400■		JD62T400■

3-Pole 600VAC

200	HHJD63B200	HHJD63F400	JD63T200
225	HHJD63B225		JD63T225
250	HHJD63B250		JD63T250
300	HHJD63B300		JD63T300
350	HHJD63B350		JD63T350
400	HHJD63B400		JD63T400

Type CJD6-A^{⑤⑥}

Fuseless Current Limiting

Red Label

Non-Interchangeable Trip (Assembled Circuit Breaker Without Lugs)		
Continuous Current Rating @ 40°C	2-Pole 600V AC/250V DC	3-Pole 600V AC/500V DC
	Catalog Number	Catalog Number
200	For 2-pole application use outside poles of 3-pole circuit breaker	CJD63B200■
225		CJD63B225■
250		CJD63B250■
300		CJD63B300■
350		CJD63B350■
400		CJD63B400■

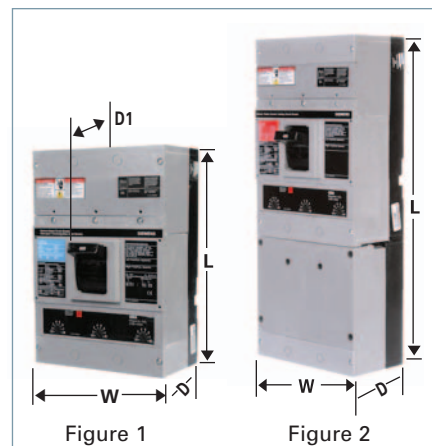

Dimensions (in inches)

Breaker Type	W	L	D	To Handle D1
Figure 1 JXD2-A, JXD6-A, JD6-A HJD6-A, HJXD6-A, HHJD6, HJD6, HJXD6, HHJXD6, JXD6-ETI [®] , SJD6, SHJD6	7.5	11	4	5.44
Figure 2 CJD6, CJD6-ETI [®] , SCJD6	7.5	17.86	4	5.44

Enclosures (Except SCJD6)

Type	Catalog Number
1	J6N1
3R	J6N3R
12	J6N12
4X	LD6SS4
7, 9 (200-250A)	EC4
7, 9 (300-400A)	EE
Neutral	W60992

Shipping Weights

Number of Poles	Number per Carton	Shipping Weight (lbs.)
JXD2, JXD6, JD6, HJD6, HHJD6 Assembled Breaker (less terminals)		
2	1	17.5
3	1	19.5
JD6, HJD6, HHJD6 Frame Only		
2	1	14
3	1	15.5
JD6 Trip Unit Only		
2	1	3.5
3	1	4
CJD6 Complete Assembled Breaker (less terminals)		
3	1	31.5

For inches / millimeters conversion, see Application Data section.

■ Built to order. Allow 2-3 weeks for delivery.

2-pole units available in 3-pole construction.

⑥ When wired as shown on page 7-4, this circuit breaker is UL listed and rated for use on 500V DC ungrounded UPS systems only.

③ For non-interchangeable 3-pole HJD6 or HHJD6 type circuit breaker change the prefix identifier to HJXD6 or HHJXD6. Price equals price of frame plus price of trip, e.g. price of HJXD63B400 equals price of HJD63F400 plus price of JD63T400. Order lugs separately.

③ JXD6-ETI, CJD6-ETI see page 7-74 for ordering information.

④ Type HJXD6, HHJXD6 Circuit Breakers are UL listed for reverse fed applications.

⑤ CE applies to non-interchangeable type HJXD6-A only.

⑥ HACR rated.

Molded Case Circuit Breakers

SJD 400A Frame Digital Solid State Sentron Sensitrip IV Series

Selection

Type SJD6-B

Blue Label

Type SHJD6-B

Black Label

Current Limiting

Type SCJD6-B

Red Label

Max Current Rating	3-Pole, 600V AC		3-Pole, 600V AC		3-Pole, 600V AC	
	Catalog Number (Advanced trip unit) ^③	Catalog Number (Basic trip unit)	Catalog Number (Advanced trip unit) ^③	Catalog Number (Basic trip unit)	Catalog Number (Advanced trip unit) ^③	Catalog Number (Basic trip unit)
200	SJD6A200LI	SJD6B200LI	SHJD6A200LI	SHJD6B200LI	SCJD6A200LI	SCJD6B200LI
300	SJD6A300LI	SJD6B300LI	SHJD6A300LI	SHJD6B300LI	SCJD6A300LI	SCJD6B300LI
400	SJD6A400LI	SJD6B400LI	SHJD6A400LI	SHJD6B400LI	SCJD6A400LI	SCJD6B400LI
200	SJD6A200LIG	SJD6B200LIG	SHJD6A200LIG	SHJD6B200LIG	SCJD6A200LIG	SCJD6B200LIG
300	SJD6A300LIG	SJD6B300LIG	SHJD6A300LIG	SHJD6B300LIG	SCJD6A300LIG	SCJD6B300LIG
400	SJD6A400LIG	SJD6B400LIG	SHJD6A400LIG	SHJD6B400LIG	SCJD6A400LIG	SCJD6B400LIG
200	SJD6A200LSI	SJD6B200LSI	SHJD6A200LSI	SHJD6B200LSI	SCJD6A200LSI	SCJD6B200LSI
300	SJD6A300LSI	SJD6B300LSI	SHJD6A300LSI	SHJD6B300LSI	SCJD6A300LSI	SCJD6B300LSI
400	SJD6A400LSI	SJD6B400LSI	SHJD6A400LSI	SHJD6B400LSI	SCJD6A400LSI	SCJD6B400LSI
200	SJD6A200LSIG	SJD6B200LSIG	SHJD6A200LSIG	SHJD6B200LSIG	SCJD6A200LSIG	SCJD6B200LSIG
300	SJD6A300LSIG	SJD6B300LSIG	SHJD6A300LSIG	SHJD6B300LSIG	SCJD6A300LSIG	SCJD6B300LSIG
400	SJD6A400LSIG	SJD6B400LSIG	SHJD6A400LSIG	SHJD6B400LSIG	SCJD6A400LSIG	SCJD6B400LSIG

SJD 400A Frame – 100% Rated^②

Blue Label

Black Label

Max Current Rating	3-Pole, 600V AC		3-Pole, 600V AC	
	Catalog Number (Advanced trip unit) ^③	Catalog Number (Basic trip unit)	Catalog Number (Advanced trip unit) ^③	Catalog Number (Basic trip unit)
200	SJD6A200LIH	SJD6B200LIH	SHJD6A200LIH	SHJD6B200LIH
300	SJD6A300LIH	SJD6B300LIH	SHJD6A300LIH	SHJD6B300LIH
400	SJD6A400LIH	SJD6B400LIH	SHJD6A400LIH	SHJD6B400LIH
200	SJD6A200LIGH	SJD6B200LIGH	SHJD6A200LIGH	SHJD6B200LIGH
300	SJD6A300LIGH	SJD6B300LIGH	SHJD6A300LIGH	SHJD6B300LIGH
400	SJD6A400LIGH	SJD6B400LIGH	SHJD6A400LIGH	SHJD6B400LIGH
200	SJD6A200LSIH	SJD6B200LSIH	SHJD6A200LSIH	SHJD6B200LSIH
300	SJD6A300LSIH	SJD6B300LSIH	SHJD6A300LSIH	SHJD6B300LSIH
400	SJD6A400LSIH	SJD6B400LSIH	SHJD6A400LSIH	SHJD6B400LSIH
200	SJD6A200LSIGH	SJD6B200LSIGH	SHJD6A200LSIGH	SHJD6B200LSIGH
300	SJD6A300LSIGH	SJD6B300LSIGH	SHJD6A300LSIGH	SHJD6B300LSIGH
400	SJD6A400LSIGH	SJD6B400LSIGH	SHJD6A400LSIGH	SHJD6B400LSIGH

Ordering Information

Pricing information for all Digital Sentron Series SJD Frames is for complete breaker only - price required lugs as separate items - lugs are suitable for 75°C Wire.

SJD6-B and SCJD6-B are acceptable for reverse connection application.
SHJD6-B are not acceptable for reverse connection application.

Shipping Weights

Breaker Type	Number per Carton	Shipping Weight (lbs)
SJD6-B	1	20
SHJD6-B	1	20
SCJD6-B	1	33

Trip Unit Adjustable Functions

Suffix Letter Code	Trip Type	Cont Current Setting	Long Time Delay	Instantaneous Pick Up	Short Time Pick Up	Short Time Fixed Delay	Short Time I ² t Delay	Ground Fault Pick Up	Ground Fault Delay
LI	LI	✓	✓	✓					
LIG	LIG	✓	✓	✓				✓	✓
LSI	LSI	✓	✓	✓	✓	✓	✓		
LSIG	LSIG	✓	✓	✓	✓	✓	✓	✓	✓

Interrupting Ratings

Breaker Type	RMS Symmetrical kA UL 489 (File E10848)		
	240V AC	480V AC	600V AC
SJD6-B	65	35	25
SHJD6-B	100	65	35
SCJD6-B	200	150	100

Neutral Transformers

Ampere Rating	Catalog Number
200	N02SJD
300	N03SJD
400	N04SJD

Note: "G" suffix in catalog number denotes circuit breaker for 3-phase, 3-wire systems.
 For 3-phase, 4-wire, order correct 4th wire (neutral) transformer as separate and additional item.

All breakers built to order. Allow 2-3 weeks for delivery.
 ① For additional information, see **Note: A**, page 7-87.
 ② Refer to the NEC for proper application of 100% rated devices.
 ③ Advanced trip unit equipped with DAS / Maintenance Mode. Requires customer-supplied 24V external power supply, maintenance switch and light.

Lugs for 75°C Wire^①

Catalog Number	No. of cables per connector	Wire Range
TA2J6500	2	#3/0-500 kcmil Cu
	2	#4/0-500 kcmil Al
TA1L6750	1	500-750 kcmil Al
	1	500-600 kcmil Cu
TC1J6600	1	#3/0-600 kcmil Cu
TC2J6500	2	#3/0-500 kcmil Cu
TA2J630	2	#4-#3/0 Cu/Al
Compression Lug		
CCL600	1 (pc.)	#1/0-500 kcmil Cu/Al

Enclosures Section 6
 Accessories pages 7-54 and 7-94 to 7-99

Molded Case Circuit Breakers

Internal Accessories

Selection

Accessories for:

JD 400A Frame
LD 600A Frame
LMD 800A Frame
SJD 400A Frame
SLD 600A Frame



Shunt Trip Combinations

Control Voltage		1 Shunt Trip	1 Shunt Trip and 1 Auxiliary Switch
AC	DC	Catalog Number	Catalog Number
24		S17JLD6	—
48		S18JLD6▲	—
120		S01JLD6	S01JLD62A
240		S03JLD6	S03JLD62A
277		S15JLD6▲	S15JLD64A▲
480		S04JLD6	—
	12	S16JLD6▲	S16JLD62A▲
	24	S07JLD6	S07JLD62A
	48	S09JLD6▲	S09JLD62A
	125	S11JLD6	S11JLD62A▲
	250	S13JLD6▲	S13JLD62A▲

Undervoltage Trip Combinations

Control Voltage		1 Undervoltage Trip	1 Undervoltage Trip and 1 Auxiliary Switch	1 Undervoltage Trip and 2 Auxiliary Switches
AC	DC	Catalog Number	Catalog Number	Catalog Number
120		U01JLD6	U01JLD62A	U01JLD62AA
208		U02JLD6▲	U02JLD62A▲	U02JLD62AA▲
240		U03JLD6	U03JLD62A▲	U03JLD62AA▲
480		U06JLD6	U06JLD64A▲	U06JLD64AA▲
	24	U13JLD6	U13JLD62A	U13JLD62AA
	48	U14JLD6▲	U14JLD62A▲	U14JLD62AA▲
	125	U10JLD6▲	U10JLD62A▲	U10JLD62AA▲
	250	U12JLD6▲	U12JLD62A▲	U12JLD62AA▲

Auxiliary Switch Combinations

Maximum Voltage		1 Form C	2 Form C
AC	DC	Catalog Number	Catalog Number
480	250	A01JLD64	A02JLD64
—	12	A01JLDLV	A02JLDLV

Alarm Switch Combinations

Maximum Voltage		1 Alarm Switch	1 Alarm Switch and 1 Auxiliary Switch	1 Alarm Switch and 2 Auxiliary Switches
AC	DC	Catalog Number	Catalog Number	Catalog Number
480	250	B01JLD64	A01JLD64B	A02JLD64B

ETU Testing Unit

Breaker Type	Description	Catalog Number
SJD, SLD, SMD, SND, SPD	Power Stick	EPSP18V
	Spare cable for Power Stick	COMPCA

The EPSP18V Power Stick is a hand-held, battery-operated power supply that can be used for trip testing the Sensitrip IV electronic trip units. Requires two 9V batteries.

Note: Accessory modules can only be added to right side pole of solid state SJD and SLD frame circuit breakers. No accessories can be added if mechanical interlock is used. All accessories on this page are useable on superseded JD2, JJ6, JL6, HJ6, SJL, LJ6, LL6, HL6 and SLL circuit breakers.

▲ Built to order. Allow 6–8 weeks for delivery.

Molded Case Circuit Breakers

LD 600A Frame Sentron Series

Selection

Type LXD6-A^{①④}

Blue Label

Non-Interchangeable Trip (Assembled Circuit Breaker without Lugs)				
Continuous Current Rating @ 40°C	2-Pole (3-Pole Width)		3-Pole	
	600V AC	250V DC	600V AC	500V DC
	Catalog Number		Catalog Number	
450	LXD62B450		LXD63B450	E
500	LXD62B500		LXD63B500	
600	LXD62B600		LXD63B600	

Type LD6-A^④

Blue Label

Interchangeable Trip			
Continuous Current Rating @ 40°C	Complete Breaker Unassembled w/Lugs	Frame Only	Trip Unit Only
	Catalog Number	Catalog Number	Catalog Number

2-Pole 600V AC, 250V DC (3-Pole Width)

Current Rating	Catalog Number	Frame Catalog Number	Trip Unit Catalog Number
250	LD62B250	LD62F600	JD62T250
300	LD62B300		JD62T300
350	LD62B350		JD62T350
400	LD62B400		JD62T400
450	LD62B450		LD62T450
500	LD62B500		LD62T500
600	LD62B600		LD62T600

3-Pole 600V AC, 500V DC^②

Current Rating	Catalog Number	Frame Catalog Number	Trip Unit Catalog Number
250	LD63B250	LD63F600	JD63T250
300	LD63B300		JD63T300
350	LD63B350		JD63T350
400	LD63B400		JD63T400
450	LD63B450		LD63T450
500	LD63B500		LD63T500
600	LD63B600		LD63T600

Interrupting Ratings

Breaker Type	RMS Symmetrical Amperes (KA)										
	UL 489 AIR (File E10848)						IEC 947-2 ^③				
	Volts AC (50/60Hz)			Volts DC			Volts AC (50/60Hz)				
	240	480	600	250	500 ^③	220/240	380/415	500	(Icu)	(Ics)	
LD6-A, LXD6-A	65	35	25	30 (2-P)	25 (3-P)	65	33	40	20	—	—
HLD6-A, HLXD6-A	100	65	35	30 (2-P)	35 (3-P)	100	50	65	33	—	—
HHL6, HHLXD6	200	100	50	—	—	—	—	—	—	—	—
CLD6-A	200	150	100	—	50 (3-P)	—	—	—	—	—	—

Instantaneous Adjustment Trip Range

Breaker Ampere Rating	Nominal Instantaneous Values							
	±20% Tolerance Low							±20% Tolerance High
		2	3	4	5	6	7	
250-300	1250	1430	1610	1790	1960	2140	2320	2500
350-450	2000	2290	2570	2860	3140	3430	3710	4000
500-600	3000	3430	3800	4290	4710	5140	5570	6000

■ Built to order. Allow 2-3 weeks for delivery.

① Type LXD6A circuit breakers are UL Listed for reverse fed applications.

② When wired as shown on page 7-4, this circuit breaker is UL listed and rated for use on 500V DC ungrounded UPS systems only.

③ See Note: A, page 7-87.

④ HACR rated.

⑤ Only applicable to interchangeable trip unit types: LXD6, HLXD6.

Note: LD frame qualified to UL489 supplement SB "NAVAL". See page 7-90 for additional information.

Modifications page 7-90
Enclosures Section 6
Accessories pages 7-58 and 7-94 to 7-99

Ordering Information

Complete Breaker Unassembled with Lugs

Prices of LD6, HLD6, and HHL6 breakers include frame, trip, and both line and load lugs (TA2J6500). When ordered by these catalog numbers, the customer will receive the frame, trip and lugs separately packaged. For applications requiring different lugs, order individual items as needed.

Complete Breaker Assembled with-out Lugs

Prices of LXD6, HLXD6, HHLXD6, and CLD6 include frame with non-interchangeable trip unit installed only. Order required lugs separately. For line and load lugs (TA2J6500) installed, add suffix "L" to catalog number (add 2 times list price of lugs for each pole).

100% Rated (3-pole only)

Types LXD6 and HLXD6 breakers are available with 100% ratings. To order add suffix "H" to catalog number, and 10% to list price. 100% rated LD breakers require the use of 90°C Cu cable sized at 75°C ampacity and lugs TC1J6600 or TC2J6500.

50°C Applications see page 7-90.

400Hz Applications see page 7-90.

Shipping Weights

Number of Poles	Number per Carton	Shipping Weight (lbs.)
LXD6, LD6, HLD6, HHL6 Assembled Breaker (less terminals)		
2	1	17.5
3	1	19.5
LD6, HLD6, HHL6 Frame Only		
2	1	14
3	1	15.5
LD6, HHL6 Trip Unit Only		
2	1	3.5
3	1	4
CLD6 Complete Assembled Breaker (less terminals)		
3	1	31.5

Lugs For 75°C Wire^③

Catalog Number	Cables per Lug	Wire Range
TA2J6500	1, 2	#3/0 500 kcmil Cu #4/0 500 kcmil Al
TC2J6500	2	#3/0-500 kcmil Cu
TA1L6750	1	500-750 kcmil Al 500-600 kcmil Cu
TC1J6600	1	#3/0-600 kcmil Cu
Compression Lug		
CCL600	1	500 kcmil Cu/Al

Molded Case Circuit Breakers

LD 600A Frame Sentron Series

Selection/Dimensions

Type HLD6-A, HLXD6-A^{②③④}

Black Label

Interchangeable Trip			
Continuous Current Rating @ 40°C	Complete Breaker Unassembled w/Lugs	Frame Only	Trip Unit Only
	Catalog Number	Catalog Number	Catalog Number

2-Pole 600V AC, 250V DC (3-Pole Width)

Current Rating	Complete Breaker Unassembled w/Lugs	Frame Only	Trip Unit Only
250	HLD62B250	HLD62F600	JD62T250
300	HLD62B300		JD62T300
350	HLD62B350		JD62T350
400	HLD62B400		JD62T400
450	HLD62B450		LD62T450
500	HLD62B500		LD62T500
600	HLD62B600		LD62T600

3-Pole 600V AC, 500V DC^{①⑤}

Current Rating	Complete Breaker Unassembled w/Lugs	Frame Only	Trip Unit Only
250	HLD63B250	HLD63F600	JD63T250
300	HLD63B300		JD63T300
350	HLD63B350		JD63T350
400	HLD63B400		JD63T400
450	HLD63B450		LD63T450
500	HLD63B500		LD63T500
600	HLD63B600		LD63T600

Type HHL6, HHLXD6^{②③④}

Black Label

2-Pole 600V AC (3-Pole Width)

Current Rating	Complete Breaker Unassembled w/Lugs	Frame Only	Trip Unit Only
250	HHL62B250	HHL62F600	JD62T250
300	HHL62B300		JD62T300
350	HHL62B350		JD62T350
400	HHL62B400		JD62T400
450	HHL62B450		HHL62T450
500	HHL62B500		HHL62T500
600	HHL62B600		HHL62T600

3-Pole 600V AC

Current Rating	Complete Breaker Unassembled w/Lugs	Frame Only	Trip Unit Only
250	HHL63B250	HHL63F600	JD63T250
300	HHL63B300		JD63T300
350	HHL63B350		JD63T350
400	HHL63B400		JD63T400
450	HHL63B450		HHL63T450
500	HHL63B500		HHL63T500
600	HHL63B600		HHL63T600

Type CLD6-A^{③④}

Fuseless Current Limiting

Red Label

Non-Interchangeable Trip (Assembled Circuit Breaker Without Lugs)

Continuous Current Rating @ 40°C	2-Pole 600V AC/250V DC	3-Pole 600V AC/500V DC
	Catalog Number	Catalog Number
450	For 2-pole application use outside poles of 3-pole circuit breaker	CLD63B450
500		CLD63B500
600		CLD63B600

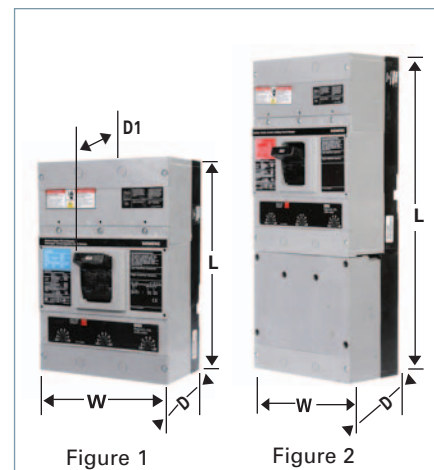

Dimensions (in inches)

Breaker Type	W	L	D	To Handle D1
Figure 1 LXD6-A, LD6-A HLD6-A HHL6, HHLXD6, LXD6-ETI ^⑥ , SLD6, SHLD6	7.5	11	4	5.44
Figure 2 CLD6, CLD6-ETI ^⑥ , SCLD6	7.5	17.86	4	5.44

Enclosures: (except SCLD6)

Type	Catalog Number
1	LD6N1
3R	LD6N3R
12	LD6N12
4X	LD6SS4
7,9	ED6
Neutral	W60993

For inches / millimeters conversion, see Application Data section.

■ Built to order. Allow 2-3 weeks for delivery.

① When wired as shown on page 7-4, this circuit breaker is UL listed and rated for use on 500V DC ungrounded UPS systems only.

② For complete assembled 3-pole HLD6 or HHL6 type circuit breaker change the prefix identifier HLD6 or HHL6 to HLXD6 or HHLXD6. Price is sum of frame and trip units prices, e.g. price of HHLXD63B400 is the price of HLD63F600 plus the price of LD63T600. Order the terminal connectors separately.

③ Type HLXD6, HHLXD6, & CLD6 Circuit Breakers are UL Listed for reverse feed applications.
④ LXD6-ETI, CLD6-ETI see page 7-74 for ordering information.
⑤ CE Applies to non-interchangeable type HLXD only.
⑥ HACR rated.

Molded Case Circuit Breakers

SLD 600A Frame Digital Solid State Sentron Sensitrip IV Series

Selection

Type SLD6-B

Blue Label

Type SHLD6-B

Black Label

Current Limiting

Type SCLD6-B

Red Label

Max Current Rating	3-Pole, 600V AC		3-Pole, 600V AC		3-Pole, 600V AC	
	Catalog Number (Advanced trip unit) ^①	Catalog Number (Basic trip unit)	Catalog Number (Advanced trip unit) ^①	Catalog Number (Basic trip unit)	Catalog Number (Advanced trip unit) ^①	Catalog Number (Basic trip unit)
300	SLD6A300LI	SLD6B300LI	SHLD6A300LI	SHLD6B300LI	SCLD6A300LI	SCLD6B300LI
400	SLD6A400LI	SLD6B400LI	SHLD6A400LI	SHLD6B400LI	SCLD6A400LI	SCLD6B400LI
500	SLD6A500LI	SLD6B500LI	SHLD6A500LI	SHLD6B500LI	SCLD6A500LI	SCLD6B500LI
600	SLD6A600LI	SLD6B600LI	SHLD6A600LI	SHLD6B600LI	SCLD6A600LI	SCLD6B600LI
300	SLD6A300LIG	SLD6B300LIG	SHLD6A300LIG	SHLD6B300LIG	SCLD6A300LIG	SCLD6B300LIG
400	SLD6A400LIG	SLD6B400LIG	SHLD6A400LIG	SHLD6B400LIG	SCLD6A400LIG	SCLD6B400LIG
500	SLD6A500LIG	SLD6B500LIG	SHLD6A500LIG	SHLD6B500LIG	SCLD6A500LIG	SCLD6B500LIG
600	SLD6A600LIG	SLD6B600LIG	SHLD6A600LIG	SHLD6B600LIG	SCLD6A600LIG	SCLD6B600LIG
300	SLD6A300LSI	SLD6B300LSI	SHLD6A300LSI	SHLD6B300LSI	SCLD6A300LSI	SCLD6B300LSI
400	SLD6A400LSI	SLD6B400LSI	SHLD6A400LSI	SHLD6B400LSI	SCLD6A400LSI	SCLD6B400LSI
500	SLD6A500LSI	SLD6B500LSI	SHLD6A500LSI	SHLD6B500LSI	SCLD6A500LSI	SCLD6B500LSI
600	SLD6A600LSI	SLD6B600LSI	SHLD6A600LSI	SHLD6B600LSI	SCLD6A600LSI	SCLD6B600LSI
300	SLD6A300LSIG	SLD6B300LSIG	SHLD6A300LSIG	SHLD6B300LSIG	SCLD6A300LSIG	SCLD6B300LSIG
400	SLD6A400LSIG	SLD6B400LSIG	SHLD6A400LSIG	SHLD6B400LSIG	SCLD6A400LSIG	SCLD6B400LSIG
500	SLD6A500LSIG	SLD6B500LSIG	SHLD6A500LSIG	SHLD6B500LSIG	SCLD6A500LSIG	SCLD6B500LSIG
600	SLD6A600LSIG	SLD6B600LSIG	SHLD6A600LSIG	SHLD6B600LSIG	SCLD6A600LSIG	SCLD6B600LSIG

Trip Unit Adjustable Functions

Suffix Letter Code	Trip Type	Cont Current Setting	Long Time Delay	Instantaneous Pick Up	Short Time Pick Up	Short Time Fixed Delay	Short Time I ² t Delay	Ground Fault Pick Up	Ground Fault Delay
LI	LI	✓	✓	✓					
LIG	LIG	✓	✓	✓				✓	✓
LSI	LSI	✓	✓	✓	✓	✓	✓		
LSIG	LSIG	✓	✓	✓	✓	✓	✓	✓	✓

Interrupting Ratings

Breaker Type	RMS Symmetrical kA UL 489 (File E10848)		
	240V AC	480V AC	600V AC
SLD6-B	65	35	25
SHLD6-B	100	65	35
SCLD6-B	200	150	100

Neutral Transformers

Ampere Rating	Catalog Number
300	N03SJD
400	N04SJD
500	N05SLD
600	N06SLD

Ordering Information

Pricing information for all Digital Sentron Series SLD Frames is for complete breaker only – price required lugs as separate items – lugs are suitable for 75°C Wire.

SLD6 and SCLD6 are acceptable for reverse connection application.

SHLD6 are not acceptable for reverse connection application.

Shipping Weights

Breaker Type	Number per Carton	Shipping Weight (lbs)
SLD6-B	1	20
SHLD6-B	1	20
SCLD6-B	1	33

Note: "G" suffix in catalog number denotes circuit breaker for 3-phase, 3-wire circuits.
For 3-phase, 4-wire, order correct 4th wire (neutral) transformer as separate and additional item.

For ordering information and terminal connectors see page 7-55; for enclosures, see page 7-56.

100% Rated – Not available in SLD6 Frame.

All breakers built to order. Allow 2-3 weeks for delivery.

^① Advanced trip unit equipped with DAS / Maintenance Mode. Requires customer-supplied 24V external power supply, maintenance switch and light.

Molded Case Circuit Breakers

Internal Accessories

Selection

Accessories for:

JD 400A Frame
LD 600A Frame
LMD 800A Frame
SJD 400A Frame
SLD 600A Frame



Shunt Trip Combinations

Control Voltage		1 Shunt Trip	1 Shunt Trip and 1 Auxiliary Switch
AC	DC	Catalog Number	Catalog Number
24		S17JLD6	—
48		S18JLD6▲	—
120		S01JLD6	S01JLD62A
240		S03JLD6	S03JLD62A
277		S15JLD6▲	S15JLD64A▲
480		S04JLD6	—
	12	S16JLD6▲	S16JLD62A▲
	24	S07JLD6	S07JLD62A
	48	S09JLD6▲	S09JLD62A
	125	S11JLD6	S11JLD62A▲
	250	S13JLD6▲	S13JLD62A▲

Undervoltage Trip Combinations

Control Voltage		1 Undervoltage Trip	1 Undervoltage Trip and 1 Auxiliary Switch	1 Undervoltage Trip and 2 Auxiliary Switches
AC	DC	Catalog Number	Catalog Number	Catalog Number
120		U01JLD6	U01JLD62A	U01JLD62AA
208		U02JLD6▲	U02JLD62A▲	U02JLD62AA▲
240		U03JLD6	U03JLD62A▲	U03JLD62AA▲
480		U06JLD6	U06JLD64A▲	U06JLD64AA▲
	24	U13JLD6	U13JLD62A	U13JLD62AA
	48	U14JLD6▲	U14JLD62A▲	U14JLD62AA▲
	125	U10JLD6▲	U10JLD62A▲	U10JLD62AA▲
	250	U12JLD6▲	U12JLD62A▲	U12JLD62AA▲

Auxiliary Switch Combinations

Maximum Voltage		1 Form C	2 Form C
AC	DC	Catalog Number	Catalog Number
480	250	A01JLD64	A02JLD64
—	12	A01JLDLV	A02JLDLV

Alarm Switch Combinations

Maximum Voltage		1 Alarm Switch	1 Alarm Switch and 1 Auxiliary Switch	1 Alarm Switch and 2 Auxiliary Switches
AC	DC	Catalog Number	Catalog Number	Catalog Number
480	250	B01JLD64	A01JLD64B	A02JLD64B

ETU Testing Unit

Breaker Type	Description	Catalog Number
SJD, SLD, SMD, SND, SPD	Power Stick	EPSP18V
	Spare cable for Power Stick	COMPCA

The EPSP18V Power Stick is a hand-held, battery-operated power supply that can be used for trip testing the Sensitrip IV electronic trip units. Requires two 9V batteries.

Note: Accessory modules can only be added to right side pole of solid state SJD and SLD frame circuit breakers. No accessories can be added if mechanical interlock is used. All accessories on this page are useable on superseded JD2, JJ6, JL6, HJ6, SJL, LJ6, LL6, HL6 and SLL circuit breakers.

▲ Built to order. Allow 6–8 weeks for delivery.

Molded Case Circuit Breakers

LMD 800A Frame Sentron Series

Selection

Type LMXD6^{①④}

Blue Label

Non-Interchangeable Trip (Assembled Circuit Breaker without Lugs)		
Continuous Current Rating @ 40°C	2-Pole (3-Pole Width) Catalog Number	3-Pole Catalog Number
500	—	LMXD63B500■
600	LMXD62B600■	LMXD63B600
700	LMXD62B700■	LMXD63B700
800	LMXD62B800	LMXD63B800

Type LMD6^④

Blue Label

Interchangeable Trip			
Continuous Current Rating @ 40°C	Complete Breaker Unassembled w/Lugs	Frame Only	Trip Unit Only
	Catalog Number	Catalog Number	Catalog Number
2-Pole 600V AC, 250V DC (3-Pole Width)			
500	LMD62B500■	LMD62F800■	LMD62T500■
600	LMD62B600■		LMD62T600■
700	LMD62B700■		LMD62T700■
800	LMD62B800■		LMD62T800■
3-Pole 600V AC, 500V DC^②			
500	LMD63B500■	LMD63F800	LMD63T500■
600	LMD63B600■		LMD63T600■
700	LMD63B700■		LMD63T700■
800	LMD63B800		LMD63T800

Instantaneous Adjustment Trip Range

Ampere Rating	Nominal Instantaneous Values							
	Low +/- 20% Tolerance	2	3	4	5	6	7	High +/- 20% Tolerance
500-600	3000	3430	3860	4290	4710	5140	5570	6000
700-800	3200	3500	3700	4200	4700	6400	7300	8000

Ordering Information

Complete Breaker Unassembled with Lugs

Prices of LMD6 and HLMD6 breakers include frame, trip, and both line and load lugs (TA3K500). These catalog numbers include the frame, trip and lugs separately packaged. For applications requiring different lugs, order individual items as needed.

Complete Breaker Assembled without Lugs

Prices of LMXD6 and HLMXD6 include frame with non-interchangeable trip unit installed only. Order required lugs separately. For line and load lugs (TA3K500) installed, add suffix "L" to catalog number (add 2 times list price of lugs for each pole).

50°C Applications see page 7-90.

400Hz Applications see page 7-90.

Shipping Weights

Number of Poles	Number per Carton	Shipping Weight (lbs.)
LMD6, HLMD6, LMXD6, HLMXD6 Complete Breaker (less terminals)		
2	1	53
3	1	61.5
LMD6, HLMD6 Frame Only		
2	1	42.25
3	1	46
LMD6, HLMD6 Trip Unit Only		
2	1	4.5
3	1	6.5

Lugs^③ for 75°C Wire

Catalog Number	Cables per Lug	Wire Range
TA2K500	1, 2	#1-500 kcmil Cu/Al
TA3K500	1-3	#1/0-500 kcmil Cu/Al
TA2N750	1, 2	500-750 kcmil Cu/Al

■ Built to order. Allow 2-3 weeks for delivery.

① LMXD6 circuit breakers are UL Listed for reverse connected applications.

② When wired as shown on page 7-4, this circuit breaker is UL listed and rated for use on 500VDC ungrounded UPS systems only.

③ See **Note: A**, page 7-87.

④ HACR rated.

Modifications page 7-90
Enclosures Section 6
Accessories pages 7-61 and 7-94 to 7-99

Molded Case Circuit Breakers

LMD 800A Frame Sentron Series

Selection/Dimensions

Type HLMXD6 ^{①④}		Black Label	
Non-Interchangeable Trip (Assembled Circuit Breaker Without Lugs)			
Continuous Current Rating @ 40°C	2-Pole 600V AC/250V DC	3-Pole 600V AC/500V DC	
	Catalog Number	Catalog Number	
500	For 2-pole application use outside poles of 3-pole circuit breaker	HLMXD63B500■	
600		HLMXD63B600■	
700		HLMXD63B700■	
800		HLMXD63B800■	



Type HLMD6 ^④		Black Label	
Interchangeable Trip			
Continuous Current Rating @ 40°C	Complete Breaker Unassembled	Frame Only	Trip Unit Only
	Catalog Number	Catalog Number	Catalog Number
2-Pole 600V AC, 250V DC (3-Pole Width)			
500	HLMD62B500■	HLMD62F800■	LMD62T500■
600	HLMD62B600■		LMD62T600■
700	HLMD62B700■		LMD62T700■
800	HLMD62B800■		LMD62T800■
3-Pole 600V AC, 500V DC^③			
500	HLMD63B500■	HLMD63F800■	LMD63T500■
600	HLMD63B600■		LMD63T600■
700	HLMD63B700■		LMD63T700■
800	HLMD63B800■		LMD63T800■

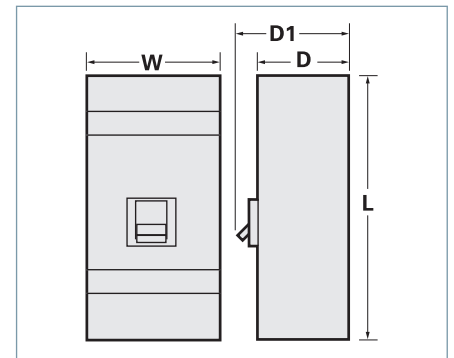

Dimensions (in inches)

Breaker Type	W	L	D	D1
LMD6, LMXD6, HLMD6, HLMXD6, LMXD6-ETI ^②	7.5	16	4.5	5.93

Enclosures

Type	Catalog Number
1	LMD1
3R	LMD3R
12	LMD12■
Neutral	W63623

Interrupting Ratings

Breaker Type	UL 489A IR				
	RMS Symmetrical Amperes (KA)				
	Volts AC			Volts DC	
	240	480	600	250	500
LMD6, LMXD6	65	50	25	30 (2-P)	25 (3-P)
HLMD6, HLMXD6	100	65	50	30 (2-P)	50 (3-P)

For inches / millimeters conversion, see Application Data section.

■ Built to order. Allow 2-3 weeks for delivery.

① HLMXD6 circuit breakers are UL Listed for reverse connection applications.

② LMXD6-ETI, see page 7-74 for catalog information.

③ When wired as shown on page 7-4, this circuit breaker is UL listed and rated for use on 500VDC ungrounded UPS systems only.

④ HACR rated.

Molded Case Circuit Breakers

Accessories for:

- JD 400A Frame
- LD 600A Frame
- LMD 800A Frame
- SJD 400A Frame
- SLD 600A Frame



S01JLD6

Sensitrip Ammeter



The Ammeter Display Units plug into the Sensitrip Trip Unit and displays the phase current flowing in the breaker. They are powered by the breaker's CT's with replaceable battery back-up for maintaining trip and max logs.

The SADU reads currents, current imbalance, current demand, and trip status.

Ammeter Mounting Kit

The Ammeter may also be panel or door mounted using the SADURMK18 remote mounting kit.

Shunt Trip Combinations

Control Voltage		1 Shunt Trip	1 Shunt Trip and 1 Auxiliary Switch
AC	DC	Catalog Number	Catalog Number
24		S17JLD6	—
48		S18JLD6▲	—
120		S01JLD6	S01JLD62A
240		S03JLD6	S03JLD62A
277		S15JLD6▲	S15JLD64A▲
480		S04JLD6	—
	12	S16JLD6▲	S16JLD62A▲
	24	S07JLD6	S07JLD62A
	48	S09JLD6▲	S09JLD62A
	125	S11JLD6	S11JLD62A▲
	250	S13JLD6▲	S13JLD62A▲

Undervoltage Trip Combinations

Control Voltage		1 Undervoltage Trip	1 Undervoltage Trip and 1 Auxiliary Switch	1 Undervoltage Trip and 2 Auxiliary Switches
AC	DC	Catalog Number	Catalog Number	Catalog Number
120		U01JLD6	U01JLD62A	U01JLD62AA
208		U02JLD6▲	U02JLD62A▲	U02JLD62AA▲
240		U03JLD6	U03JLD62A▲	U03JLD62AA▲
480		U06JLD6	U06JLD64A▲	U06JLD64AA▲
	24	U13JLD6	U13JLD62A	U13JLD62AA
	48	U14JLD6▲	U14JLD62A▲	U14JLD62AA▲
	125	U10JLD6▲	U10JLD62A▲	U10JLD62AA▲
	250	U12JLD6▲	U12JLD62A▲	U12JLD62AA▲

Auxiliary Switch Combinations

Maximum Voltage		1 Form C	2 Form C
AC	DC	Catalog Number	Catalog Number
480	250	A01JLD64	A02JLD64
—	12	A01JLDLV	A02JLDLV

Alarm Switch Combinations

Maximum Voltage		1 Alarm Switch	1 Alarm Switch and 1 Auxiliary Switch	1 Alarm Switch and 2 Auxiliary Switches
AC	DC	Catalog Number	Catalog Number	Catalog Number
480	250	B01JLD64	A01JLD64B	A02JLD64B

Plug-in Ammeter Display Units

Breaker Type	Description	Catalog Number
SJD, SLD	Display Unit	SADU
	Remote Mounting Kit	SADURMK18

Note: Accessory modules can only be added to right side pole of solid state SJD and SLD frame circuit breakers. No accessories can be added if mechanical interlock is used. All accessories on this page are useable on superseded JD2, JJ6, JL6, HJ6, SJL, LJ6, LL6, HL6 and SLL circuit breakers.

▲ Built to order. Allow 6–8 weeks for delivery.

Molded Case Circuit Breakers

MD 800A Frame Sentron Series

Selection

Type MXD6^{①⑥}

Blue Label

Non-Interchangeable Trip (Assembled Circuit Breaker Without Lugs)		
Continuous Current Rating @ 40°C	2-Pole ^②	3-Pole
	Catalog Number	Catalog Number
600	MXD62B600■	MXD63B600
700	MXD62B700■	MXD63B700
800	MXD62B800■	MXD63B800

Type MD6^⑥

Blue Label

Interchangeable Trip			
Continuous Current Rating @ 40°C	Complete Breaker Unassembled with Lugs	Frame Only	Trip Unit Only
	Catalog Number	Catalog Number	Catalog Number

2-Pole 600V AC, 250V DC^②

Continuous Current Rating @ 40°C	Catalog Number	Frame Only Catalog Number	Trip Unit Only Catalog Number
500	MD62B500■	MD62F800■	MD62T500■
600	MD62B600■		MD62T600■
700	MD62B700■		MD62T700■
800	MD62B800■		MD62T800■

3-Pole 600V AC, 500V DC^③

Continuous Current Rating @ 40°C	Catalog Number	Frame Only Catalog Number	Trip Unit Only Catalog Number
500	MD63B500	MD63F800	MD63T500
600	MD63B600		MD63T600
700	MD63B700		MD63T700
800	MD63B800		MD63T800

Lugs^④

Catalog Number	Cables Per Lug	Lugs Per Kit	Wire Range
TA2K500	1-2	1	#1-500 kcmil Cu/Al
TA3K500	1-3	1	1/0-500 kcmil Cu/Al
TC2K500	1-2	1	#1-500 kcmil Cu
TC3K350	1-3	1	#1-350 kcmil Cu
Kits			
2TA2N8750 3TA2N8750	1-2	2 3	500-750 kcmil Cu/Al
2TA3N8750 3TA3N8750	1-3	2 3	500-750 kcmil Cu/Al
2TA4N8500 3TA4N8500	1-4	2 3	250-500 kcmil Cu/Al
2TA4P8500 3TA4P8500	1-4	2 3	250-500 kcmil Cu/Al

Instantaneous Adjustment Trip Range

Ampere Rating	Nominal Instantaneous Values							
	Low +/- 20% Tolerance	2	3	4	5	6	7	High +/- 20% Tolerance
500	3000	3430	3860	4280	4710	5140	5570	6000
600-800	4000	4570	5140	5710	6280	6850	7420	8000

■ Built to order. Allow 2-3 weeks for delivery.

①MXD6 circuit breakers are UL Listed for reverse connection applications.

②2-pole units available in 3-pole width only.

③ When wired as shown on page 7-4, this circuit breaker is UL listed and rated for use on 500V DC ungrounded UPS systems.

⑥ See **Note: A**, page 7-87.

⑧ 80% rated breakers with the CE mark will also be marked in the 100% rated version.

⑨ HACR rated.

Note: MD frame qualified to UL489 supplement B "NAVAL". See page 7-90 for additional information.

Ordering Information

Complete Breaker Unassembled with Lugs

Pricing information for MD6 and HMD6 breakers includes frame, trip, and both line and load lugs (TA3K500). When ordered by these catalog numbers, the customer will receive the frame, trip and lugs separately packaged. For applications requiring different lugs, order individual items as needed.

Complete Breaker Assembled without Lugs

Prices of MXD6, HMXD6 and CMD6 include frame with non-interchangeable trip units installed only. Order required lugs separately. For line and load lugs (TA3K500) installed, add suffix "L" to catalog number (add 2 times list price of lugs for each pole).

100% Rated^③ 3-Pole Only

Types MXD6, HMXD6 and CMD6 breakers are available with 100% ratings. To order add suffix "H" to catalog number, and 10% to list price. 100% rated MD breakers require the use of 90°C Cu cable sized at 75°C ampacity and lugs 3TA4P8500 or 3TA2N8750.

50°C Applications see page 7-90.

400Hz Applications see page 7-90.

Shipping Weights

Number of Poles	Number per Carton	Shipping Weight (lbs.)
MD6, HMD6, HMXD6, CMD6 Complete Breaker Assembled (less lugs)		
2	1	53
3	1	61.5
MD6, HMD6 Frame Only		
2	1	42.25
3	1	46
MD6, HMD6 Trip Unit Only		
2	1	4.5
3	1	6.5
SMD6 Breaker		
3	1	61.5

Enclosures

Type	Catalog Number
1	MND61
3R	MND63
12	MND612■
Neutral	W63623

Modifications page 7-90
Enclosures Section 6
Accessories pages 7-65 and 7-94 to 7-99

Molded Case Circuit Breakers

MD 800A Frame Sentron Series

Selection/Dimensions

Type HMXD6^{①⑤}

Black Label

Non-Interchangeable Trip (Assembled Circuit Breaker Without Lugs)		
Continuous Current Rating @ 40°C	2-Pole 600V AC/250V DC	3-Pole 600V AC/500V DC
	Catalog Number	Catalog Number
600	For 2-pole application use outside poles of 3-pole circuit breaker	HMXD63B600■
700		HMXD63B700■
800		HMXD63B800

Type HMD6^⑤

Black Label

Interchangeable Trip			
Continuous Current Rating @ 40°C	Complete Breaker Unassembled w/Lugs	Frame Only	Trip Unit Only
	Catalog Number	Catalog Number	Catalog Number

2-Pole 600V AC, 250V DC^②

500	HMD62B500■	HMD62F800■	MD62T500■
600	HMD62B600■		MD62T600■
700	HMD62B700■		MD62T700■
800	HMD62B800■		MD62T800■

3-Pole 600V AC, 500V DC^④

500	HMD63B500	HMD63F800	MD63T500
600	HMD63B600		MD63T600
700	HMD63B700		MD63T700
800	HMD63B800		MD63T800

Type CMD6^{①⑤}

Fuseless Current Limiting

Red Label

Non-Interchangeable Trip (Assembled Circuit Breaker Without Lugs)		
Continuous Current Rating @ 40°C	2-Pole 600V AC/250V DC	3-Pole 600V AC/500V DC
	Catalog Number	Catalog Number
600	For 2-pole application use outside poles of 3-pole circuit breaker	CMD63B600■
700		CMD63B700■
800		CMD63B800

Interrupting Ratings

Breaker Type	UL 489 AIR—File E10848					IEC 947-2 AIR ^⑥					
	RMS Symmetrical Amperes (KA)					Volts AC (50/60HZ)					
	Volts AC			Volts DC		220/240		380/415		500	
	240	480	600	250	500 ^④	(lcu)	(lcs)	(lcu)	(lcs)	(lcu)	(lcs)
MD6, MXD6	65	50	25	30 (2-P)	25 (3-P)	65	33	40	20	—	—
HMD6, HMXD6	100	65	50	30 (2-P)	50 (3-P)	100	50	65	33	—	—
CMD6	200	100	65	—	50 (3-P)	—	—	—	—	—	—

For inches / millimeters conversion, see Application Data section.

■ Built to order. Allow 2-3 weeks for delivery.

① HMXD6 and CMD circuit breakers are UL listed for reverse connection applications.

② 2-pole units available in 3-pole width only.

③ MXD6-ETI, CMD6-ETI see page 7-74 for catalog information.

④ When wired as shown on page 7-4, this circuit breaker is UL listed and rated for use on 500V DC ungrounded UPS systems only.

⑤ HACR rated.

⑥ Only applicable to interchangeable trip unit types: MXD6, HMXD6

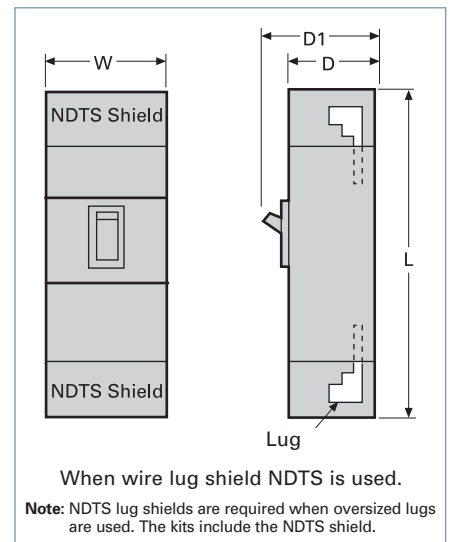

Dimensions (in inches)

Breaker Type	W	L	D	(To Handle) D1
MD6, MXD6, HMD6, HMXD6, CMD6, MXD6-ETI, CMD6-ETI, SMD6-B, SHMD6-B, and SCMD6-B	9	16	6	8.25
with lug shields	9	24	6	8.25

MOLDED CASE CIRCUIT BREAKERS

Molded Case Circuit Breakers

SMD 800A Frame Digital Solid State Sentron Sensitrip IV Series

Selection

Type SMD6

Blue Label

Type SHMD6-B

Black Label

Current Limiting

Type SCMD6-B

Red Label

Max Current Rating	3-Pole, 600V AC		3-Pole, 600V AC		3-Pole, 600V AC	
	Catalog Number (Advanced trip unit) ^③	Catalog Number (Basic trip unit)	Catalog Number (Advanced trip unit) ^③	Catalog Number (Basic trip unit)	Catalog Number (Advanced trip unit) ^③	Catalog Number (Basic trip unit)
600	SMD6A600LI	SMD6B600LI	SHMD6A600LI	SHMD6B600LI	SCMD6A600LI	SCMD6B600LI
700	SMD6A700LI	SMD6B700LI	SHMD6A700LI	SHMD6B700LI	SCMD6A700LI	SCMD6B700LI
800	SMD6A800LI	SMD6B800LI	SHMD6A800LI	SHMD6B800LI	SCMD6A800LI	SCMD6B800LI
600	SMD6A600LIG	SMD6B600LIG	SHMD6A600LIG	SHMD6B600LIG	SCMD6A600LIG	SCMD6B600LIG
700	SMD6A700LIG	SMD6B700LIG	SHMD6A700LIG	SHMD6B700LIG	SCMD6A700LIG	SCMD6B700LIG
800	SMD6A800LIG	SMD6B800LIG	SHMD6A800LIG	SHMD6B800LIG	SCMD6A800LIG	SCMD6B800LIG
600	SMD6A600LSI	SMD6B600LSI	SHMD6A600LSI	SHMD6B600LSI	SCMD6A600LSI	SCMD6B600LSI
700	SMD6A700LSI	SMD6B700LSI	SHMD6A700LSI	SHMD6B700LSI	SCMD6A700LSI	SCMD6B700LSI
800	SMD6A800LSI	SMD6B800LSI	SHMD6A800LSI	SHMD6B800LSI	SCMD6A800LSI	SCMD6B800LSI
600	SMD6A600LSIG	SMD6B600LSIG	SHMD6A600LSIG	SHMD6B600LSIG	SCMD6A600LSIG	SCMD6B600LSIG
700	SMD6A700LSIG	SMD6B700LSIG	SHMD6A700LSIG	SHMD6B700LSIG	SCMD6A700LSIG	SCMD6B700LSIG
800	SMD6A800LSIG	SMD6B800LSIG	SHMD6A800LSIG	SHMD6B800LSIG	SCMD6A800LSIG	SCMD6B800LSIG

SMD 800A Frame – 100% Rated^①

Blue Label

Black Label

Current Limiting

Red Label

Max Current Rating	3-Pole, 600V AC		3-Pole, 600V AC		3-Pole, 600V AC	
	Catalog Number (Advanced trip unit) ^③	Catalog Number (Basic trip unit)	Catalog Number (Advanced trip unit) ^③	Catalog Number (Basic trip unit)	Catalog Number (Advanced trip unit) ^③	Catalog Number (Basic trip unit)
600	SMD6A600LIH	SMD6B600LIH	SHMD6A600LIH	SHMD6B600LIH	SCMD6A600LIH	SCMD6B600LIH
700	SMD6A700LIH	SMD6B700LIH	SHMD6A700LIH	SHMD6B700LIH	SCMD6A700LIH	SCMD6B700LIH
800	SMD6A800LIH	SMD6B800LIH	SHMD6A800LIH	SHMD6B800LIH	SCMD6A800LIH	SCMD6B800LIH
600	SMD6A600LIGH	SMD6B600LIGH	SHMD6A600LIGH	SHMD6B600LIGH	SCMD6A600LIGH	SCMD6B600LIGH
700	SMD6A700LIGH	SMD6B700LIGH	SHMD6A700LIGH	SHMD6B700LIGH	SCMD6A700LIGH	SCMD6B700LIGH
800	SMD6A800LIGH	SMD6B800LIGH	SHMD6A800LIGH	SHMD6B800LIGH	SCMD6A800LIGH	SCMD6B800LIGH
600	SMD6A600LSIH	SMD6B600LSIH	SHMD6A600LSIH	SHMD6B600LSIH	SCMD6A600LSIH	SCMD6B600LSIH
700	SMD6A700LSIH	SMD6B700LSIH	SHMD6A700LSIH	SHMD6B700LSIH	SCMD6A700LSIH	SCMD6B700LSIH
800	SMD6A800LSIH	SMD6B800LSIH	SHMD6A800LSIH	SHMD6B800LSIH	SCMD6A800LSIH	SCMD6B800LSIH
600	SMD6A600LSIGH	SMD6B600LSIGH	SHMD6A600LSIGH	SHMD6B600LSIGH	SCMD6A600LSIGH	SCMD6B600LSIGH
700	SMD6A700LSIGH	SMD6B700LSIGH	SHMD6A700LSIGH	SHMD6B700LSIGH	SCMD6A700LSIGH	SCMD6B700LSIGH
800	SMD6A800LSIGH	SMD6B800LSIGH	SHMD6A800LSIGH	SHMD6B800LSIGH	SCMD6A800LSIGH	SCMD6B800LSIGH

7
MOLDED CASE
CIRCUIT BREAKERS

Ordering Information		
Pricing information for all Digital Sentron Series MD frames is for complete breaker only. Price requires lugs or lug kits as separate items. Lugs are suitable for 75°C wire or as noted. Connector wire ranges and cavities are established in conjunction with Table 6.1.4.2.1 of UL 489 standards. Choose actual connector for circuit breakers based on customer requirements.		
Recommended Terminal Connectors		
Breaker Frame	Ampere Rating	Connector or Connector Kit
MD	500-600	TA2K500
MD	700-800	TA3K500
Types SMD6-B, SHMD6-B and SCMD6-B are acceptable for reverse connection applications		

Lugs for 75°C Wire^②

Catalog Number	Cables per Lug	Wire Range	Each kit contains the following:
TA2K500	2	#1-500 kcmil Cu/Al	
TA3K500	3	#1-500 kcmil Cu/Al	
TC2K500	2	#1-500 kcmil Cu	
TC3K350	3	#1-350 kcmil Cu	3TA3N8750 - 3 connectors plus 1 NDTs end barrier
Kits (3 lugs/kit)			
3TA4N8500	4	250-500 kcmil Cu/Al	3TA2N8750 - 3 connectors plus 1 NDTs end barrier
3TA4P8500	4	250-500 kcmil Cu/Al	
3TA2N8750	2	500-750 kcmil Cu/Al	
3TA3N8750	3	500-750 kcmil Cu/Al	

Trip Unit Adjustable Functions

Suffix Letter Code	Trip Type	Cont Current Setting	Long Time Delay	Instantaneous Pick Up	Short Time Pick Up	Short Time Delay	Ground Fault Pick Up	Ground Fault Delay
LI	LI	✓	✓	✓				
LIG	LIG	✓	✓	✓			✓	✓
LSI	LSI	✓	✓	✓	✓	✓		
LSIG	LSIG	✓	✓	✓	✓	✓	✓	✓

Note: "G" suffix in catalog number denotes circuit breaker for 3-phase, 3-wire circuits. For 3-phase, 4-wire, order correct 4th wire (neutral) transformer as separate and additional item.

① Use 2-3TA4P8500 for 3-pole. These kits are rated for 90°C wire. 90°C Cu only cable must be used, and sized per 75°C ampacity.
② For additional information, see **Note: A**, page 7-87.

All breakers built to order. Allow 2-3 weeks for delivery.

Interrupting Ratings

Breaker Type	RMS Symmetrical kA UL 489 (File E10848)		
	240V AC	480V AC	600V AC
SMD6-B	65	50	25
SHMD6-B	100	65	50
SCMD6-B	200	100	65

Neutral Transformers

Ampere Rating	Catalog Number
600	N06SMDA
700	N07SMDA
800	N08SMDA

③ Advanced trip unit equipped with DAS / Maintenance Mode. Requires customer-supplied 24V external power supply, maintenance switch and light.

Enclosures Section 6
Accessories pages 7-65 and 7-94 to 7-99

Molded Case Circuit Breakers

Internal Accessories

Selection

Accessories for:

MD/SMD 800A Frame
ND/SND 1200A Frame
PD/SPD 1600A Frame
RD 2000A Frame



S01MN6

Accessory modules can mount in either left hand or right hand poles of all circuit breakers, including solid state. Exception: when mechanical interlock is used. Accessories cannot be mounted in left pole.

Shunt Trip Combinations

Control Voltage		1 Shunt Trip	1 Shunt Trip and 1 Auxiliary Switch
AC	DC	Catalog Number	Catalog Number
120		S01MN6	S01MN64A
208		S02MN6▲	—
240		S03MN6	S03MN64A▲
277		S15MN6▲	S15MN64A▲
480		S04MN6▲	S04MN64A▲
600		S06MN6▲	—
	12	S16MN6▲	S16MN64A▲
	24	S07MN6	S07MN64A
	48	S09MN6▲	—
	125	S11MN6	S11MN64A▲
	250	S13MN6▲	S13MN64A▲

Undervoltage Trip Combinations

Control Voltage		1 Undervoltage Trip	1 Undervoltage Trip and 1 Auxiliary Switch	1 Undervoltage Trip and 2 Auxiliary Switches
AC	DC	Catalog Number	Catalog Number	Catalog Number
120		U01MN6	U01MN64A	U01MN64AA
208		U02MN6▲	U02MN64A▲	U02MN64AA▲
240		U03MN6▲	U03MN64A▲	U03MN64AA▲
277		U15MN6▲	U15MN64A▲	U15MN64AA▲
480		U04MN6▲	U04MN64A▲	U04MN64AA▲
600		U06MN6▲	—	—
	24	U07MN6	U07MN64A	U07MN64AA
	48	U09MN6▲	U09MN64A▲	U09MN64AA▲
	125	U11MN6▲	U11MN64A▲	U11MN64AA▲
	250	U13MN6▲	U13MN64A▲	U13MN64AA▲

Auxiliary Switch Combinations

Maximum Voltage		1 Form C	2 Form C
AC	DC	Catalog Number	Catalog Number
480	250	A01MN64	A02MN64
—	12	A01MNDLV▲	A02MNDLV▲

Alarm Switch Combinations

Maximum Voltage		1 Alarm Switch	1 Alarm Switch and 1 Auxiliary Switch	1 Alarm Switch and 2 Auxiliary Switches
AC	DC	Catalog Number	Catalog Number	Catalog Number
480	250	B00MN64	A01MN64B	A02MN64B

ETU Testing Unit

Breaker Type	Description	Catalog Number
SJD, SLD, SMD, SND, SPD	Power Stick	EPSP18V
	Spare cable for Power Stick	COMPCA

The EPSP18V Power Stick is a hand-held, battery-operated power supply that can be used for trip testing the Sensitrip IV electronic trip units. Requires two 9V batteries.

▲ Built to order. Allow 6–8 weeks for delivery.

Molded Case Circuit Breakers

ND 1200A Frame Sentron Series

Selection

Type NXD6^{①③}

Blue Label

Non-Interchangeable Trip (Assembled Circuit Breaker Without Lugs)

Continuous Current Rating @ 40°C	2-Pole 600V AC/250V DC	3-Pole 600V AC/500V DC
	Catalog Number	Catalog Number
900	NXD62B900■	NXD63B900
1000	NXD62B100■	NXD63B100
1200	NXD62B120■	NXD63B120

Type ND6^⑧

Blue Label

Interchangeable Trip

Continuous Current Rating @ 40°C	Complete Breaker Unassembled with Lugs	Frame Only	Trip Unit Only
	Catalog Number	Catalog Number	Catalog Number

2-Pole 600V AC, 250V DC^②

Continuous Current Rating @ 40°C	Complete Breaker Unassembled with Lugs	Frame Only	Trip Unit Only
800	ND62B800■	ND62F120	MD62T800■
900	ND62B900■		ND62T900■
1000	ND62B100■		ND62T100■
1200	ND62B120		ND62T120

3-Pole 600V AC, 500V DC^③

Continuous Current Rating @ 40°C	Complete Breaker Unassembled with Lugs	Frame Only	Trip Unit Only
800	ND63B800	ND63F120	MD63T800
900	ND63B900		ND63T900
1000	ND63B100		ND63T100
1200	ND63B120		ND63T120

Interrupting Ratings

Breaker Type	RMS Symmetrical Amperes (KA)										
	UL 489 A IR					IEC 947-2 ^④					
	Volts AC			Volts DC		Volts AC (50/60HZ)					
	240	480	600	250	500 ^⑤	220/240		380/415		500	
					(lcu)	(lcs)	(lcu)	(lcs)	(lcu)	(lcs)	
ND6, NXD6	65	50	25	30 (2-P)	25 (3-P)	65	33	40	20	—	—
HND6, HNXD6	100	65	50	30 (2-P)	50 (3-P)	100	50	65	33	—	—
CND6	200	100	65	—	50 (3-P)	—	—	—	—	—	—

Instantaneous Adjustment Trip Range

Breaker Ampere Rating	Nominal Instantaneous Values							
	±20% Tolerance Low	2	3	4	5	6	7	±20% Tolerance High
	800	4000	4570	5140	5710	6280	6850	7420
900-1200	5000	5715	6430	7145	7860	8575	9290	10000

■ Built to order. Allow 2-3 weeks for delivery.

①NXD6 circuit breakers are UL listed for reverse connection applications.

②2-pole units available in 3-pole width only.

③When wired as shown on page 7-4, this circuit breaker is UL listed and rated for use on 500VDC ungrounded UPS systems only.

④Use 2 – 3TA4P8500 kits for 3-pole, or 2 – 2TA4P8500 kits for 2-pole. Rated for 90°C cable. Use for 100% rated breakers.

⑤Use 2 – 3TA4N8500 for 3-pole or 2 – 2TA4N8500 for 2-pole. Rated for 75°C cable.

⑥See **Note: A**, page 7-87.

⑦80% rated breakers with the CE mark will also be marked in the 100% rated version.

⑧HACR rated.

⑨ Only applicable to interchangeable trip unit types: NXD6, HNXD6.

Note: ND frame qualified to UL489 supplement B "NAVAL". See page 7-90 for additional information.

Ordering Information

Complete Breaker Unassembled with Lugs

Prices of ND6 and HND6 breakers include frame, trip, and both line and load lugs (3TA4N8500). These catalog numbers are the frame, trip and lugs separately packaged. For applications requiring different lugs, order individual items as needed.

Complete Breaker Assembled without Lugs

Prices of NXD6, HNXD6, and CND6 include frame with non-interchangeable trip units installed only. Order required terminal connectors separately. For line and load lugs (3TA4N8500) installed, add suffix "L" to catalog number (add 2 times list price of lug kit).

100% Rated (3-Pole only)^⑦

Types NXD6, HNXD6 and CND6 breakers are available with 100% ratings. To order, add suffix "H" to catalog number, and add 10% to list price. 100% rated ND breakers require 90°C Cu cable sized at 75°C ampacity and lug kit 3TA4P8500 or 3TA3N8750.

50°C Applications see page 7-90.

400Hz Applications see page 7-90.

Lugs^⑥

Catalog Number	Cables per Lug	Wire Range
TA2K500	2	#1-500 kcmil Cu/Al
TA3K500	3	#1-500 kcmil Cu/Al
TC2K500	2	#1-500 kcmil Cu
TC3K350	3	#1-350 kcmil Cu

Kits (2 Kits required per breaker)

2TA4P8500 ^④	4	250-500 kcmil Cu/Al
3TA4P8500 ^④		
2TA4N8500 ^⑤	4	250-500 kcmil Cu/Al
3TA4N8500 ^⑤		
2TA2N8750	2	500-750 kcmil Cu/Al
3TA2N8750		
2TA3N8750	3	500-750 kcmil Cu/Al
3TA3N8750		

Enclosures

Type	Catalog Number
1	MND61
3R	MND63
12	MND612■
Neutral	W63623

Modifications page 7-90
Enclosures Section 6
Accessories pages 7-69 and 7-94 to 7-99

Molded Case Circuit Breakers

ND 1200A Frame Sentron Series

Selection/Dimensions

Type HNXD6^{①④}

Black Label

Non-Interchangeable Trip (Assembled Circuit Breaker Without Lugs)

Continuous Current Rating @ 40°C	2-Pole 600V AC/250V DC	3-Pole 600V AC/500V DC
	Catalog Number	Catalog Number
900	For 2-pole application use outside poles of 3-pole circuit breaker	HNXD63B900
1000		HNXD63B100
1200		HNXD63B120

Type HND6^④

Black Label

Interchangeable Trip

Continuous Current Rating @ 40°C	Complete Breaker Unassembled with Lugs	Frame Only	Trip Unit Only
	Catalog Number	Catalog Number	Catalog Number
800	HND63F120	HND63F120	MD63T800
900			ND63T900
1000			ND63T100
1200			ND63T120

2-Pole 600V AC, 250V DC^②

800	For 2-pole application use outside poles of 3-pole circuit breaker
900	
1000	
1000	
1200	

3-Pole 600V AC, 500V DC^③

800	HND63B800	HND63F120	MD63T800
900	HND63B900		ND63T900
1000	HND63B100		ND63T100
1000	HND63B100		ND63T100
1200	HND63B120		ND63T120

Type CND6^{①④}

Fuseless Current Limiting

Red Label

Non-Interchangeable Trip (Assembled Circuit Breaker)

Continuous Current Rating @ 40°C	2-Pole	3-Pole
	Catalog Number	Catalog Number
900	For 2-pole application, use outside poles of 3-pole circuit breaker	CND63B900■
1000		CND63B100
1200		CND63B120

Shipping Weights

Number of Poles	Number per Carton	Shipping Weight (lbs.)
ND6, HND6, NXD6, HNXD6, CND6 Assembled Breaker (less terminals)		
2	1	53
3	1	61.5
ND6, HND6 Frame Only		
2	1	42.25
3	1	46
ND6, HND6 Trip Unit Only		
2	1	4.5
3	1	6.5



NXD63B120

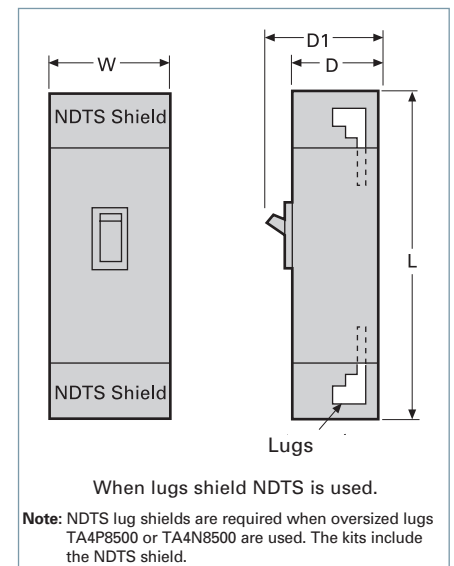

Dimensions (in inches)

Breaker Type	W	L	D	D1
ND6, NXD6, HND6, HNXD6, CND6, SND6-B, SHND6-B, and SCND6-B	9	16	6	8.25
with NDTS lug shield	9	24	6	8.25

For inches / millimeters conversion, see Application Data section.

■ Built to order. Allow 2–3 weeks for delivery.

① HNXD6 and CND6 circuit breakers are UL Listed for reverse connection applications.

② 2-pole units available in 3-pole width only.

③ When wired as shown on page 7-4, this circuit breaker is UL listed and rated for use on 500V DC ungrounded UPS systems only.

④ HACR rated.

Molded Case Circuit Breakers

SND 1200A Frame Digital Solid State Sentron Sensitrip IV Series^②
Selection

Type SND6-B

Blue Label

Type SHND6-B

Black Label
Current Limiting

Type SCND6-B

Red Label

Max Current Rating	3-Pole, 600V AC		3-Pole, 600V AC		3-Pole, 600V AC	
	Catalog Number (Advanced trip unit) ^③	Catalog Number (Basic trip unit)	Catalog Number (Advanced trip unit) ^③	Catalog Number (Basic trip unit)	Catalog Number (Advanced trip unit) ^③	Catalog Number (Basic trip unit)
800	SND6A800LI	SND6B800LI	SHND6A800LI	SHND6B800LI	SCND6A800LI	SCND6B800LI
1000	SND6A100LI	SND6B100LI	SHND6A100LI	SHND6B100LI	SCND6A100LI	SCND6B100LI
1200	SND6A120LI	SND6B120LI	SHND6A120LI	SHND6B120LI	SCND6A120LI	SCND6B120LI
800	SND6A800LIG	SND6B800LIG	SHND6A800LIG	SHND6B800LIG	SCND6A800LIG	SCND6B800LIG
1000	SND6A100LIG	SND6B100LIG	SHND6A100LIG	SHND6B100LIG	SCND6A100LIG	SCND6B100LIG
1200	SND6A120LIG	SND6B120LIG	SHND6A120LIG	SHND6B120LIG	SCND6A120LIG	SCND6B120LIG
800	SND6A800LSI	SND6B800LSI	SHND6A800LSI	SHND6B800LSI	SCND6A800LSI	SCND6B800LSI
1000	SND6A100LSI	SND6B100LSI	SHND6A100LSI	SHND6B100LSI	SCND6A100LSI	SCND6B100LSI
1200	SND6A120LSI	SND6B120LSI	SHND6A120LSI	SHND6B120LSI	SCND6A120LSI	SCND6B120LSI
800	SND6A800LSIG	SND6B800LSIG	SHND6A800LSIG	SHND6B800LSIG	SCND6A800LSIG	SCND6B800LSIG
1000	SND6A100LSIG	SND6B100LSIG	SHND6A100LSIG	SHND6B100LSIG	SCND6A100LSIG	SCND6B100LSIG
1200	SND6A120LSIG	SND6B120LSIG	SHND6A120LSIG	SHND6B120LSIG	SCND6A120LSIG	SCND6B120LSIG

SND 1200A Frame – 100% Rated^①

Type SND6-B

Blue Label

Type SHND6-B

Black Label
Current Limiting

Type SCND6-B

Red Label

Max Current Rating	3-Pole, 600V AC		3-Pole, 600V AC		3-Pole, 600V AC	
	Catalog Number (Advanced trip unit) ^③	Catalog Number (Basic trip unit)	Catalog Number (Advanced trip unit) ^③	Catalog Number (Basic trip unit)	Catalog Number (Advanced trip unit) ^③	Catalog Number (Basic trip unit)
800	SND6A800LIH	SND6B800LIH	SHND6A800LIH	SHND6B800LIH	SCND6A800LIH	SCND6B800LIH
1000	SND6A100LIH	SND6B100LIH	SHND6A100LIH	SHND6B100LIH	SCND6A100LIH	SCND6B100LIH
1200	SND6A120LIH	SND6B120LIH	SHND6A120LIH	SHND6B120LIH	SCND6A120LIH	SCND6B120LIH
800	SND6A800LIGH	SND6B800LIGH	SHND6A800LIGH	SHND6B800LIGH	SCND6A800LIGH	SCND6B800LIGH
1000	SND6A100LIGH	SND6B100LIGH	SHND6A100LIGH	SHND6B100LIGH	SCND6A100LIGH	SCND6B100LIGH
1200	SND6A120LIGH	SND6B120LIGH	SHND6A120LIGH	SHND6B120LIGH	SCND6A120LIGH	SCND6B120LIGH
800	SND6A800LSIH	SND6B800LSIH	SHND6A800LSIH	SHND6B800LSIH	SCND6A800LSIH	SCND6B800LSIH
1000	SND6A100LSIH	SND6B100LSIH	SHND6A100LSIH	SHND6B100LSIH	SCND6A100LSIH	SCND6B100LSIH
1200	SND6A120LSIH	SND6B120LSIH	SHND6A120LSIH	SHND6B120LSIH	SCND6A120LSIH	SCND6B120LSIH
800	SND6A800LSIGH	SND6B800LSIGH	SHND6A800LSIGH	SHND6B800LSIGH	SCND6A800LSIGH	SCND6B800LSIGH
1000	SND6A100LSIGH	SND6B100LSIGH	SHND6A100LSIGH	SHND6B100LSIGH	SCND6A100LSIGH	SCND6B100LSIGH
1200	SND6A120LSIGH	SND6B120LSIGH	SHND6A120LSIGH	SHND6B120LSIGH	SCND6A120LSIGH	SCND6B120LSIGH

Trip Unit Adjustable Functions

Suffix Letter Code	Trip Type	Cont Current Setting	Long Time Delay	Instantaneous Pick Up	Short Time Pick Up	Short Time Fixed Pick Up	Short Time I ² t Delay	Ground Fault Pick Up	Ground Fault Delay
LI	LI	✓	✓	✓					
LIG	LIG	✓	✓	✓				✓	✓
LSI	LSI	✓	✓	✓	✓	✓	✓		
LSIG	LSIG	✓	✓	✓	✓	✓	✓	✓	✓

Interrupting Ratings

Breaker Type	RMS Symmetrical kA UL 489 (File E10848)		
	240V AC	480V AC	600V AC
SND6-B	65	50	25
SHND6-B	100	65	50
SCND6-B	200	100	65

Neutral Transformers

Ampere Rating	Catalog Number
800	N08SMDA
1000	N10SNDA
1200	N12SNDA

For inches / millimeters conversion, see Application Data section.

For ordering information and terminal connectors, and enclosures, see page 7-66.

Note: "G" suffix in catalog number denotes circuit breaker for 3-phase, 3-wire circuits.
 For 3-phase, 4-wire, order correct 4th wire (neutral) transformer as separate and additional item.

All breakers built to order. Allow 2–3 weeks for delivery.

^① Use 2-3TA4P8500 for 3-pole. These kits are rated for 90°C wire. 90°C Cu only cable must be used, and sized per 75°C ampacity.

^② SND6, SHND6 and SCND6 circuit breakers are UL Listed for reverse connection applications.

^③ Advanced trip unit equipped with DAS / Maintenance Mode. Requires customer-supplied 24V external power supply, maintenance switch and light.

Molded Case Circuit Breakers

Internal Accessories

Selection

Accessories for:

MD/SMD 800A Frame
ND/SND 1200A Frame
PD/SPD 1600A Frame
RD 2000A Frame



S01MN6

Accessory modules can mount in either left hand or right hand poles of all circuit breakers, including solid state. Exception: when mechanical interlock is used. Accessories cannot be mounted in left pole.

Shunt Trip Combinations

Control Voltage		1 Shunt Trip	1 Shunt Trip and 1 Auxiliary Switch
AC	DC	Catalog Number	Catalog Number
120		S01MN6	S01MN64A
208		S02MN6▲	—
240		S03MN6	S03MN64A▲
277		S15MN6▲	S15MN64A▲
480		S04MN6▲	S04MN64A▲
600		S06MN6▲	—
	12	S16MN6▲	S16MN64A▲
	24	S07MN6	S07MN64A
	48	S09MN6▲	—
	125	S11MN6	S11MN64A▲
	250	S13MN6▲	S13MN64A▲

Undervoltage Trip Combinations

Control Voltage		1 Undervoltage Trip	1 Undervoltage Trip and 1 Auxiliary Switch	1 Undervoltage Trip and 2 Auxiliary Switches
AC	DC	Catalog Number	Catalog Number	Catalog Number
120		U01MN6	U01MN64A	U01MN64AA
208		U02MN6▲	U02MN64A▲	U02MN64AA▲
240		U03MN6▲	U03MN64A▲	U03MN64AA▲
277		U15MN6▲	U15MN64A▲	U15MN64AA▲
480		U04MN6▲	U04MN64A▲	U04MN64AA▲
600		U06MN6▲	—	—
	24	U07MN6	U07MN64A	U07MN64AA
	48	U09MN6▲	U09MN64A▲	U09MN64AA▲
	125	U11MN6▲	U11MN64A▲	U11MN64AA▲
	250	U13MN6▲	U13MN64A▲	U13MN64AA▲

Auxiliary Switch Combinations

Maximum Voltage		1 Form C	2 Form C
AC	DC	Catalog Number	Catalog Number
480	250	A01MN64	A02MN64
—	12	A01MNDLV▲	A02MNDLV▲

Alarm Switch Combinations

Maximum Voltage		1 Alarm Switch	1 Alarm Switch and 1 Auxiliary Switch	1 Alarm Switch and 2 Auxiliary Switches
AC	DC	Catalog Number	Catalog Number	Catalog Number
480	250	B00MN64	A01MN64B	A02MN64B

ETU Testing Unit

Breaker Type	Description	Catalog Number
SJD, SLD, SMD, SND, SPD	Power Stick	EPSP18V
	Spare cable for Power Stick	COMPCA

The EPSP18V Power Stick is a hand-held, battery-operated power supply that can be used for trip testing the Sensitrip IV electronic trip units. Requires two 9V batteries.

▲ Built to order. Allow 6–8 weeks for delivery.

Molded Case Circuit Breakers

PD 1600A Frame Sentron Series

Selection

Type PXD6² Non-Interchangeable Trip⁵

3-Pole 600V AC, 250-500V DC¹

Blue Label

Continuous Current Rating @ 40°C	Complete Breaker Assembled (Frame/Trip Unit Only)		Mounting Assembly	Lugs (6 required)
	Catalog Number		Catalog Number	Catalog Number
1200	PXD63B120■		MB9301 -or- MBR9302	TA5P600
1400	PXD63B140■			
1600	PXD63B160			

Type PD6 Interchangeable Trip⁵

3-Pole 600V AC, 250-500V DC¹

Blue Label

Continuous Current Rating @ 40°C	Complete Breaker Unassembled	Frame Only	Trip Unit Only	Mounting Assembly	Lugs (6 required)
	Catalog Number	Catalog Number	Catalog Number	Catalog Number	Catalog Number
1200	PD63B120■	PD63F160	PD63T120■	MB9301 -or- MBR9302	TA5P600
1400	PD63B140		PD63T140		
1600	PD63B160		PD63T160		

Type HPXD6² Non-Interchangeable Trip⁵

3-Pole 600V AC, 250-500V DC¹

Blue Label

Continuous Current Rating @ 40°C	Complete Breaker Assembled (Frame/Trip Unit Only)	
	Catalog Number	
1200	HPXD63B120■	
1400	HPXD63B140■	
1600	HPXD63B160	

Type HPD6 Interchangeable Trip⁵

3-Pole 600V AC, 250-500V DC¹

Black Label

Continuous Current Rating @ 40°C	Complete Breaker Unassembled	Frame Only	Trip Unit Only	Mounting Assembly	Lugs (6 required)
	Catalog Number	Catalog Number	Catalog Number	Catalog Number	Catalog Number
1200	HPD63B120■	HPD63F160	PD63T120■	MB9301 -or- MBR9302	TA5P600
1400	HPD63B140		PD63T140		
1600	HPD63B160		PD63T160		

Type CPD6 Non-Interchangeable Trip⁵

Fuseless Current Limiting

3-Pole 600V AC, 250-500V DC¹

Red Label

Continuous Current Rating @ 40°C	Complete Breaker Assembled (Frame/Trip Unit Only)	
	Catalog Number	
1200	CPD63B120■	
1400	CPD63B140■	
1600	CPD63B160■	

Interrupting Ratings

Breaker Type	UL 489 A IR				
	RMS Symmetrical KA				
	Volts AC			Volts DC ³	
	240	480	600	250	500
PD6, PXD6	65	50	25	30 (2P)	25 (3P)
HPD6, HPXD6	100	65	50	30 (2P)	50 (3P)
CPD6	200	100	65	30 (2P)	50 (3P)

■ Built to order. Allow 2-3 weeks for delivery.

▲ Built to order. Allow 6-8 weeks for delivery.

① Use two outside poles of a 3-pole circuit breaker for 250V

② When wired as shown on page 7-4, this circuit breaker is

UL listed and rated for use on 500V DC ungrounded UPS systems only.

③ PXD6, HPXD6 and CPD6 type circuit breakers are UL Listed for reverse feed applications.

④ For additional information See **Note: A**, page 7-87.

Ordering Instructions

Complete Breaker Unassembled with Lugs

Prices of PD6, HPD6, RD6, and HRD6 type breakers include frame, trip, mounting base (MB9301), and both line and load lugs (PD Frame – TA5P600, RD Frame – TC5R600). When ordered by these catalog numbers, the customer will receive the frame, trip, mounting assembly and lugs separately packaged. For applications requiring different mounting base or lugs, order individual items as needed.

Complete Breaker Assembled without Lugs

Prices of PXD6, HPXD6, RXD6, HRXD6 and CPD6 type breakers include frame with non-interchangeable trip unit installed only. Order required mounting base and lugs separately.

100% Rated (3-Pole only)

Types PXD6, HPXD6 breakers are available with 100% ratings. To order add suffix "H" to catalog number, and 10% to list price. 100% PD breakers require 90° C cable sized at 75° C ampacity and TC5R600 lugs. RD 2000A Frames not available with 100% ratings.

50°C Applications see page 7-90.

400HZ Applications see page 7-90.

Lugs (6 required per breaker)⁴

Catalog Number	No of Cables per Connector	Wire Range
TA5P600	1-5	300-600 kcmil Cu/Al
TC5R600	1-5	300-600 kcmil Cu only
TA4P750▲	1-4	600-750 kcmil Cu/Al
TA6R600	1-6	300-600 kcmil Cu/Al

④ HACR rated.

Note: PD frame qualified to UL489 supplement B "NAVAL". See page 7-90 for additional information.

Molded Case Circuit Breakers

SPD 1600A Frame Digital Solid State Sentron Sensitrip IV Series

Selection/Dimensions

Type SPD6-B

Blue Label

Type SHPD6-B

Black Label

Max Current Rating	3-Pole, 600V AC		3-Pole, 600V AC	
	Catalog Number (Advanced trip unit) ^③	Catalog Number (Basic trip unit)	Catalog Number (Advanced trip unit) ^③	Catalog Number (Basic trip unit)
1400	SPD6A140LI	SPD6B140LI	SHPD6A140LI	SHPD6B140LI
1600	SPD6A160LI	SPD6B160LI	SHPD6A160LI	SHPD6B160LI
1400	SPD6A140LIG	SPD6B140LIG	SHPD6A140LIG	SHPD6B140LIG
1600	SPD6A160LIG	SPD6B160LIG	SHPD6A160LIG	SHPD6B160LIG
1400	SPD6A140LSI	SPD6B140LSI	SHPD6A140LSI	SHPD6B140LSI
1600	SPD6A160LSI	SPD6B160LSI	SHPD6A160LSI	SHPD6B160LSI
1400	SPD6A140LSIG	SPD6B140LSIG	SHPD6A140LSIG	SHPD6B140LSIG
1600	SPD6A160LSIG	SPD6B160LSIG	SHPD6A160LSIG	SHPD6B160LSIG

Ordering Information

Pricing information for all Digital Sentron Series PD frame unit is for breaker only. Price required mounting block assembly and necessary terminal connectors as separate items.

SPD6-B and SHPD6-B are acceptable for reverse connection applications.

Lugs^①

Catalog Number	No. of cables per connector	Wire Range
TA5P600	1-5 pcs.	300-600 kcmil Cu/Al
TC5R600	1-5 pcs.	300-600 kcmil Cu Only
TA6R600	1-6 pcs.	300-600 kcmil Cu/Al

Neutral Transformers

Ampere Rating	Catalog Number
1400	N14SPD
1600	N16SPD

Enclosure

Type	Catalog Number
1	PRD6N1

Trip Unit Adjustable Functions

Suffix Letter Code	Trip Type	Cont Current Setting	Long Time Delay	Instantaneous Pick Up	Short Time Pick Up	Short Time Fixed Delay	Short Time I ² t Delay	Ground Fault Pick Up	Ground Fault Delay
LI	LI	✓	✓	✓					
LIG	LIG	✓	✓	✓				✓	✓
LSI	LSI	✓	✓	✓	✓	✓	✓		
LSIG	LSIG	✓	✓	✓	✓	✓	✓	✓	✓

Interrupting Ratings

Breaker Type	RMS Symmetrical kA UL 489		
	240V AC	480V AC	600V AC
SPD6-B	65	50	25
SHPD6-B	100	65	50

Mounting Block (Required)^②

Catalog Number
MB9301
MBR9302

All PD, RD Frames:

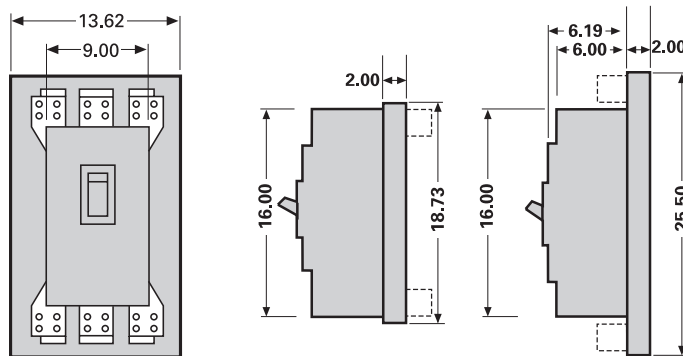

MB9301 (shown)
MBR9302

MBR9302

MB9301

MBR9302

MB9301



For inches / millimeters conversion, see Application Data section.

Note: "G" suffix in catalog number denotes circuit breaker for 3-phase, 3-wire circuits.
For 3-phase, 4-wire, order correct 4th wire (neutral) transformer as separate and additional item.

All breakers built to order. Allow 2-3 weeks for delivery.
^① For additional information, see **Note: A**, page 7-87.
^② The PD frame circuit breaker requires the use of a connect-all mounting assembly to allow for placing into service.

^③ Advanced trip unit equipped with DAS / Maintenance Mode. Requires customer-supplied 24V external power supply, maintenance switch and light.

Molded Case Circuit Breakers

Internal Accessories

Selection

Accessories for:

MD/SMD 800A Frame
ND/SND 1200A Frame
PD/SPD 1600A Frame
RD 2000A Frame



S01MN6

Accessory modules can mount in either left hand or right hand poles of all circuit breakers, including solid state. Exception: when mechanical interlock is used. Accessories cannot be mounted in left pole.

Shunt Trip Combinations

Control Voltage		1 Shunt Trip	1 Shunt Trip and 1 Auxiliary Switch
AC	DC	Catalog Number	Catalog Number
120		S01MN6	S01MN64A
208		S02MN6▲	—
240		S03MN6	S03MN64A▲
277		S15MN6▲	S15MN64A▲
480		S04MN6▲	S04MN64A▲
600		S06MN6▲	—
	12	S16MN6▲	S16MN64A▲
	24	S07MN6	S07MN64A
	48	S09MN6▲	—
	125	S11MN6	S11MN64A▲
	250	S13MN6▲	S13MN64A▲

Undervoltage Trip Combinations

Control Voltage		1 Undervoltage Trip	1 Undervoltage Trip and 1 Auxiliary Switch	1 Undervoltage Trip and 2 Auxiliary Switches
AC	DC	Catalog Number	Catalog Number	Catalog Number
120		U01MN6	U01MN64A	U01MN64AA
208		U02MN6▲	U02MN64A▲	U02MN64AA▲
240		U03MN6▲	U03MN64A▲	U03MN64AA▲
277		U15MN6▲	U15MN64A▲	U15MN64AA▲
480		U04MN6▲	U04MN64A▲	U04MN64AA▲
600		U06MN6▲	—	—
	24	U07MN6	U07MN64A	U07MN64AA
	48	U09MN6▲	U09MN64A▲	U09MN64AA▲
	125	U11MN6▲	U11MN64A▲	U11MN64AA▲
	250	U13MN6▲	U13MN64A▲	U13MN64AA▲

Auxiliary Switch Combinations

Maximum Voltage		1 Form C	2 Form C
AC	DC	Catalog Number	Catalog Number
480	250	A01MN64	A02MN64
—	12	A01MNDLV▲	A02MNDLV▲

Alarm Switch Combinations

Maximum Voltage		1 Alarm Switch	1 Alarm Switch and 1 Auxiliary Switch	1 Alarm Switch and 2 Auxiliary Switches
AC	DC	Catalog Number	Catalog Number	Catalog Number
480	250	B00MN64	A01MN64B	A02MN64B

ETU Testing Unit

Breaker Type	Description	Catalog Number
SJD, SLD, SMD, SND, SPD	Power Stick	EPSP18V
	Spare cable for Power Stick	COMPCA

The EPSP18V Power Stick is a hand-held, battery-operated power supply that can be used for trip testing the Sensitrip IV electronic trip units. Requires two 9V batteries.

▲ Built to order. Allow 6–8 weeks for delivery.

Molded Case Circuit Breakers

RD 2000A Frame Sentron Series

Selection

Type RXD6^④

3-Pole 600V AC, 250-500V DC^①

Blue Label

Non-Interchangeable Trip (Assembled Circuit Breaker Only Without Lugs)			
Continuous Current Rating @ 40°C	Complete Breaker Assembled (Frame/Trip Unit Only) Catalog Number	Mounting Assembly Catalog Number	Lugs (6 required) Catalog Number
1600	RXD63B160	MB9301	TC5R600
1800	RXD63B180	-or-	
2000	RXD63B200	MBR9302	

Type RD6^④

3-Pole 600V AC, 250-500V DC^①

Blue Label

Interchangeable Trip (Unassembled Circuit Breaker with Lugs)					
Continuous Current Rating @ 40°C	Complete Breaker Unassembled Catalog Number	Frame Only Catalog Number	Trip Unit Only Catalog Number	Mounting Assembly Catalog Number	Lugs (6 required) Catalog Number
1600	RD63B160■	RD63F200	RD63T160■	MB9301	TC5R600
1800	RD63B180		RD63T180	-or-	
2000	RD63B200		RD63T200	MBR9302	

Type HRXD6^④

Black Label

Continuous Current Rating @ 40°C	Complete Breaker Assembled (Frame/Trip Unit Only)	
	Catalog Number	
1600	HRXD63B160■	
1800	HRXD63B180■	
2000	HRXD63B200	

Type HRD6^④

Black Label

Continuous Current Rating @ 40°C	Complete Breaker Unassembled Catalog Number	Frame Only Catalog Number	Trip Unit Only Catalog Number	Mounting Assembly Catalog Number	Lugs (6 required) Catalog Number
1600	HRD63B160■	HRD63F200	RD63T160■	MB9301	TC5R600
1800	HRD63B180		RD63T180	-or-	
2000	HRD63B200		RD63T200	MBR9302	

Interrupting Ratings

Breaker Type	UL 489 A IR					
	RMS Symmetrical KA					
	Volts AC			Volts DC ^①		
	240	480	600	250	500	
RD6, RXD6	65	50	25	30 (2P)	25 (3P)	
HRD6, HRXD6	100	65	50	30 (2P)	50 (3P)	

Instantaneous Adjustment Trip Range (PD / RD Frames)

Breaker Ampere Rating	Nominal Instantaneous Values							±20% Tolerance High
	±20% Tolerance Low	2	3	4	5	6	7	
	1200-2000	5000	5715	6430	7145	7860	8575	

■ Built to order. Allow 2-3 weeks for delivery.

▲ Built to order. Allow 6-8 weeks for delivery.

① Use two outside poles of a 3-pole circuit breaker for 250V DC applications.

④ When wired as shown on page 7-4, this circuit breaker is UL listed and rated for use on 500V DC ungrounded UPS systems only.

⑤ RXD6 and HRXD6 type circuit breakers are UL Listed for reverse feed applications.

⑥ HACR rated.

⑦ For additional information See Note: A, page 7-87.

Note: RD frame qualified to UL489 supplement B "NAVAL". See page 7-90 for additional information.

⑧ For required mounting base (MB9301 or MBR9302) see page 7-71.



RXD63B200

Mounting Block^⑧

Catalog Number	Connection Points
MB9301	Front
MBR9302	Rear

Shipping Weights

Number of Poles	Number per Carton	Shipping Weight (lbs.)
PXD6, HPXD6, RXD6, HRXD6, CPD6 Assembled Breakers		
3	1	61.5
PD6, HPD6, RD6, HRD6 Frame Only		
3	1	55.0
PD6, RD6 Trip Unit Only		
3	1	6.5
Mounting Assembly		
MB9301	1	53.0
MBR9302	1	50.9

Lugs (6 required per breaker)^⑧

Catalog Number	No of Cables per Connector	Wire Range
TC5R600	1-5	300-600 kcmil Cu only
TA6R600	1-6	300-600 kcmil Cu/Al

7 MOLDED CASE CIRCUIT BREAKERS

Molded Case Circuit Breakers

Magnetic Trip Only — ETI Motor Circuit Protector

Selection

Breaker Type	Ampere Rating	Instantaneous Trip Range ^②		Complete Circuit Breaker Without Lugs ^③		
		Minimum ^③	Maximum ^③	Catalog Number 2-Pole	Catalog Number 3-Pole	
HEM	3	9	33	—	HEM3M003L	
	7	21	77	—	HEM3M007L	
	15	45	165	—	HEM3M015L	
	30	90	330	—	HEM3M030L	
	50	150	550	—	HEM3M050L	
	70	210	770	—	HEM3M070L	
	100	300	1100	—	HEM3M100L	
	SHIPPING:					3.7 lbs. each
ED6-A 600V AC 250V DC	1	2.6	9	—	ED63A001	
	2	7	22	—	ED63A002	
	3	10	35	—	ED63A003	
	5	16	54	—	ED63A005	
	10	30	100	—	ED63A010	
	25	55	180	—	ED63A025	
	30	80	270	—	ED63A030	
	40	115	375	—	ED63A040	
	50	180	600	—	ED63A050	
	100	315	1000	—	ED63A100	
	125	500	1250	—	ED63A125	
	SHIPPING:					3.8 lbs. each
	CED6-A 600V AC 250V DC	1	2.6	9	—	CED63A001■
2		7	22	—	CED63A002■	
3		10	35	—	CED63A003■	
5		16	54	—	CED63A005■	
10		30	100	—	CED63A010■	
25		55	180	—	CED63A025■	
30		80	270	—	CED63A030■	
40		115	375	—	CED63A040■	
50		180	600	—	CED63A050■	
100		315	1000	—	CED63A100■	
125	500	1250	—	CED63A125■		
SHIPPING:					6 lbs. each	
FXD6 ^④ 600V AC 250V DC	150	400	800	—	FXD63L150■	
	150	800	1500	—	FXD63A150	
	150	1100	2500	—	FXD63H150	
	250	1100	2500	—	FXD63A250	
SHIPPING:					9 lbs. each	
CFD6 ^④ 600V AC 250V DC	150	400	800	—	CFD63L150■	
	150	800	1500	—	CFD63A150■	
	150	1100	2500	—	CFD63H150■	
	250	1100	2500	—	CFD63A250■	
SHIPPING:					12 lbs. each	
JXD6(A) ^① 600V AC 250V DC	400	1250	2500	—	JXD63L400	
	400	2000	4000	JXD62H400■	JXD63H400	
SHIPPING:					16 lbs. each	
CJD6 ^① 600V AC 250V DC	400	1250	2500	—	CJD63L400■	
	400	2000	4000	—	CJD63H400■	
SHIPPING:					29.5 lbs. each	
LXD6(A) ^① 600V AC 250V DC	600	2000	4000	LXD62L600■	LXD63L600■	
	600	3000	6000	—	LXD63H600	
SHIPPING:					20 lbs. each	
CLD6 ^① 600V AC 250V DC	600	2000	4000	—	CLD63L600■	
	600	3000	6000	—	CLD63H600■	
SHIPPING:					31.5 lbs. each	
LMXD6 ^④ 600V AC 250V DC	800	2800	6000	—	LMXD63L800■	
	800	3200	8000	—	LMXD63A800	
SHIPPING:					35 lbs. each	
MXD6 ^④ 600V AC 250V DC	800	3000	6000	—	MXD63L800■	
	800	4000	8000	—	MXD63A800■	
	800	5000	10000	—	MXD63H800	
SHIPPING:					33 lbs. each	
CMD6 ^④ 600V AC 250V DC	800	3000	6000	—	CMD63L800■	
	800	4000	8000	—	CMD63A800■	
	800	5000	10000	—	CMD63H800■	
SHIPPING:					80 lbs. each	

Important Information

ETI interrupting ratings are determined through combination tests with properly sized overload relays and contactors.

⑤ **Connectors included when ordering by circuit breaker catalog number for HEM, ED and CED6 ETIs. Order ETI circuit breaker and lugs (2 per pole) separately for the FXD6, CFD6, MXD6, CMD6, JXD6, CJD6, LXD6 and CLD6 ETI's.**

■ Built to order. Allow 2-3 weeks for delivery.

① 2-pole available in 3-pole width only.

② When applied on DC Circuits — Trip levels will increase approximately +15 to 20%.

③ Tolerance -20%/+30% for lowest setting. All other set-

tings are -20%/+20%

④ For 2-pole application use outside poles of 3-pole circuit breaker.

Lug Information pages 7-87 to 7-89
Enclosures Section 6
Accessories pages 7-94 to 7-99
Application data pages 7-75 to 7-76

Molded Case Circuit Breakers

General

Protection of Motor Circuits

Molded case circuit breakers are used in motor circuits as a disconnecting means and for short-circuit protection. They should be used in conjunction with motor-running, over-current-protection devices, and should permit the motor to start without nuisance tripping from motor-inrush current. The circuit breaker should have a continuous-current rating of not less than 115% of the motor full-load current.

The recommended motor circuit protectors (Siemens ETI instantaneous only circuit breakers) listed have

continuous-current ratings of at least 115% of motor full-load currents. The trip-setting positions are approximately 11 times motor full-load currents. The suggested trip settings may have to be adjusted upward to no higher than 1300% of full-load current for non-design E type motors, and no greater than 1700% of full load current for design E motors, to allow for motor start-up due to inrush currents.

Breaker Mounted Immediately Ahead of Motor Starter

Siemens ETI motor circuit protectors are recommended for use in combination motor starters to provide selective short-circuit protection for the motor

branch circuit. The adjustable instantaneous-trip feature of the Siemens ETI motor circuit protector provides for a trip setting slightly above the peak motor-inrush current. With this setting, no delay is introduced in opening the circuit when a fault occurs. This circuit breaker has no time-delay trip element. Therefore it must be used in conjunction with, and immediately ahead of, the motor-running overcurrent protective device.

Important: The information below does not apply to all motor applications: it is recommended that the user refer to the National Electrical Code (NEC) for specific needs.

Table 1 (When Breaker is Mounted Immediately Ahead of Motor Starter)

3-Phase Induction Type Motors (Siemens ETI motor circuit protectors for branch circuit use with alternating-current combination, full voltage motor starters).

Motor Full Load Amperes	Catalog Number	ETI Trip Setting		Motor Full Load Amperes	Catalog Number	ETI Trip Setting		Motor Full Load Amperes	Catalog Number	ETI Trip Setting	
		Adjustment	Amperes			Adjustment	Amperes			Adjustment	Amperes
0.69 – 0.91	HEM3M003L	A (min)	9	1.23 – 1.99	ED63A005 CED63A005	Low	16	95.00 – 110.00	JXD63L400 CJD63L400	Low	1250
1.1 – 1.3		B	15	2.00 – 2.75		2	26	110.00 – 124.00		2	1430
1.6 – 1.7		C	21	2.76 – 3.52		3	36	138.00 – 151.00		4	1790
2.0 – 2.2		D	27	3.53 – 4.14		4	46	165.00 – 178.00		6	2140
2.3 – 2.5		E	30	4.15 – 4.90		High	54	178.00 – 192.00		7	2320
2.6 – 2.8		F (max)	33					192.00 – 227.00		High	2500
1.5 – 2.0	HEM3M007L	A (min)	21	2.30 – 3.83	ED63A010 CED63A010	Low	30	154.00 – 176.00	JXD63H400 CJD63H400	Low	2000
2.6 – 3.1		B	35	3.84 – 5.37		2	50	176.00 – 198.00		2	2290
3.7 – 3.9		C	49	5.38 – 6.52		3	70	220.00 – 242.00		4	2860
4.8 – 5.2		D	63	6.53 – 7.68		4	85	264.00 – 285.00		6	3430
5.3 – 5.7		E	70	7.69 – 9.10		High	100	285.00 – 308.00		7	3710
5.8 – 6.1		F (max)	77					308.00 – 326.00		High	4000
3.4 – 4.5	HEM3M015L	A (min)	45	4.23 – 6.91	ED63A025 CED63A025	Low	55	155.00 – 176.00	LXD63L600 CLD63L600	Low	2000
5.7 – 6.8		B	75	6.92 – 9.61		2	90	176.00 – 198.00		2	2290
8.0 – 9.1		C	100	9.62 – 11.91		3	125	220.00 – 242.00		4	2860
10.4 – 11.4		D	135	11.92 – 13.83		4	155	264.00 – 285.00		6	3430
11.5 – 12.6		E	150	13.84 – 16.40		High	180	285.00 – 308.00		7	3710
12.7 – 13.0		F (max)	165					308.00 – 326.00		High	4000
3.9 – 9.1	HEM3M030L	A (min)	90	6.15 – 10.37	ED63A030 CED63A030	Low	80	231.00 – 264.00	LXD63H600 CLD63H600	Low	3000
11.5 – 13.7		B	150	10.38 – 14.22		2	135	264.00 – 292.00		2	3430
16.1 – 18.3		C	210	14.23 – 18.06		3	185	330.00 – 362.00		4	4290
20.7 – 22.9		D	270	18.07 – 20.75		4	235	395.00 – 428.00		6	5140
23.0 – 25.2		E	300	20.76 – 24.50		High	270	428.99 – 462.00		7	5570
25.3 – 26.1		F (max)	330					462.00 – 490.00		High	6000
11.5 – 15.2	HEM3M050L	A (min)	150	8.84 – 14.22	ED63A040 CED63A040	Low	115	215.00 – 238.00	LMXD63L800	Low	2800
19.2 – 22.9		B	250	14.23 – 19.60		2	185	238.00 – 261.00		2	3100
26.9 – 30.6		C	350	19.61 – 24.99		3	255	261.00 – 284.00		3	3400
34.6 – 38.3		D	450	25.00 – 28.83		4	325	308.00 – 369.00		5	4000
38.4 – 42.1		E	500	28.84 – 34.00		High	375	369.00 – 423.00		6	4800
42.2 – 43.5		F (max)	550					423.00 – 462.00		7	5500
16.1 – 30.6	HEM3M070L	A (min)	210	13.84 – 23.06	ED63A050 CED63A050	Low	180	246.00 – 269.00	LMXD63A800	Low	3200
26.9 – 32.2		B	350	23.07 – 31.52		2	300	269.00 – 284.00		2	3500
37.6 – 42.9		C	490	31.53 – 39.99		3	410	284.00 – 323.00		3	3700
48.4 – 53.7		D	630	40.00 – 46.14		4	520	362.00 – 492.00		5	4700
53.8 – 59.1		E	700	46.15 – 54.50		High	600	492.00 – 562.00		6	6400
59.2 – 60.9		F (max)	770					562.00 – 616.00		7	7300
23.0 – 30.9	HEM3M100L	A (min)	300	24.23 – 41.52	ED63A100 CED63A100	Low	315	284.00 – 323.00	MXD63L800 CMD63L800	Low	3000
38.4 – 46.0		B	500	41.53 – 56.91		2	540	292.00 – 292.00		2	3430
53.8 – 61.4		C	700	56.92 – 68.45		3	740	362.00 – 395.00		3	3800
69.2 – 76.8		D	900	68.46 – 76.91		4	890	362.00 – 395.00		5	4710
76.9 – 84.5		E	1000	76.92 – 90.90		High	1000	428.00 – 462.00		7	5570
84.6 – 87.0		F (max)	1100					462.00 – 490.00		High	6000
.20 – .33	ED63A001 CED63A001	Low	2.6	30.76 – 35.37	FXD63L150 CFD63L150	Low	400	308.00 – 352.00	MXD63A800 CMD63A800	Low	4000
.34 – .45		2	4.5	35.38 – 39.99		2	460	352.00 – 442.00		2	4570
.46 – .56		3	6	44.51 – 49.23		4	580	442.00 – 447.00		3	5740
.57 – .68		4	7.5	53.84 – 58.45		6	700	483.00 – 527.00		5	6280
.69 – .81		High	9	58.46 – 63.06		7	760	571.00 – 616.00		7	7240
.53 – .83	ED63A002 CED63A002	Low	7	61.53 – 69.22	FXD63A150 CFD63A150	Low	800	616.00 – 660.00	MXD63H800 CMD63H800	Low	5000
.84 – 1.14		2	11	69.23 – 76.91		2	900	385.00 – 440.00		3	6430
1.15 – 1.45		3	15	84.61 – 92.29		4	1100	495.00 – 550.00		5	7860
1.46 – 1.68		4	19	100.00 – 108.00		6	1300	605.00 – 660.00		6	8575
1.69 – 2.00		High	22	108.00 – 115.00		7	1400	660.00 – 695.00		High	8000
.76 – 1.29	ED63A003 CED63A003	Low	10	115.00 – 136.00	FXD63A250 CFD63A250	Low	1100			Low	5000
1.30 – 1.75		2	17	85.00 – 100.00		2	1300			3	6430
1.76 – 2.29		3	23	100.00 – 115.00		4	1700			5	7860
2.30 – 2.68		4	30	131.00 – 146.00		6	2100			6	8575
2.69 – 3.18		High	35	162.00 – 177.00		7	2300			High	8000
				177.00 – 192.00							
				192.00 – 227.00							

Note: Lowest instantaneous settings have a -20%/+30% tolerance and all other settings have a -20%/+20% tolerance.

Molded Case Circuit Breakers

Breaker Mounted at a Distance From Motor Starter

ET thermal-magnetic circuit breakers conform to the National Electrical Code table 430-52 requirements for motor branch and feeder circuit protection when properly applied in conjunction with motor-running overcurrent protective devices. The recommended

circuit-breaker ratings in Table 2 provide adequate time delay for starting the majority of three phase induction motors.

To determine the ampere ratings of the ET breaker to protect a motor feeder, add the rating of the ET breaker used to protect the largest motor branch circuit in the group to the full-load currents of the remaining motors in the group.

Interrupt Ratings

For normal commercial purposes, available fault current can conveniently be obtained in the Interrupting Selector Tables.

Table 2 (When Breaker is Mounted at a Distance From Motor Starter)

3-Phase Induction Type Motors (EQ and ET circuit breakers (thermal-magnetic trip) for branch breaker use with alternating-current combination motor starters).

Motor Horsepower Rating	200 and 208V Motors			230V Motors			460V Motors			575V Motors		
	240V Circuit Breaker Data ^①			240V Circuit Breaker Data ^①			480V Circuit Breaker Data ^①			600V Circuit Breaker Data ^①		
	Breaker Type	Catalog Number	Ampere Rating	Breaker Type	Catalog Number	Ampere Rating	Breaker Type	Catalog Number	Ampere Rating	Breaker Type	Catalog Number	Ampere Rating
1/2	BQ [®]	BQ3B015	15	BQ [®]	BQ3B015	15	ED4	ED43B015	15	ED6	ED63B015	15
3/4		BQ3B015	15		BQ3B015	15		ED43B015	15		ED63B015	15
1		BQ3B015	15		BQ3B015	15		ED43B015	15		ED63B015	15
1 1/2		BQ3B015	15		BQ3B015	15		ED43B015	15		ED63B015	15
2		BQ3B020	20		BQ3B015	15		ED43B015	15		ED63B015	15
3		BQ3B030	30		BQ3B020	20		ED43B015	15		ED63B015	15
5	BQ [®]	BQ3B040	40	BQ [®]	BQ3B030	30	ED4	ED43B015	15	ED6	ED63B015	15
7 1/2		BQ3B060	60		BQ3B050	50		ED43B030	30		ED63B020	20
10		BQ3B070	70		BQ3B070	70		ED43B030	30		ED63B030	30
15		BQ3B100	100		BQ3B090	90		ED43B040	40		ED63B035	35
20					BQ3B100	100		ED43B050	50		ED63B050	50
25	FXD6	FXD63B125	125	FXD6	FXD63B125	125	FXD6	FXD63B090	90	FXD6	FXD63B060	60
30		FXD63B150	150		FXD63B150	150		FXD63B100	100		FXD63B070	70
40		FXD63B175	175		FXD63B175	175		FXD63B125	125		FXD63B090	90
50		FXD63B200	200		FXD63B200	200		FXD63B150	150		FXD63B100	100
		FXD63B225	225									
60	JXD2	JXD23B300	300	—	—	—	FXD6, FD6	FXD63B150	150	FXD6	FXD63B100	100
75	JXD2	JXD23B400	400	JXD2	JXD23B350	350	FXD6, FD6	FXD63B200	200	FXD6, FD6	FXD63B125	125
100	JXD2	JXD23B400	400	JXD2	JXD23B400	400	FD6 [®] JD6 [®]	FD63B250 JD63B250	250 250	FXD6, FD6	FD63B175	175
125	LD6 [®] or LMD6	LD63B600 LMD63B600	600	LD6 [®] or LMD6	LD63B500 or LMD63B500	500	JD6 [®]	JD63B300	300	FXD6, FD6 OR JD6 [®]	FXD63B200 JD63B200	200 200
150	LD6 [®] or LMD6	LD63B600 or LMD63B600	600	LMD6	LD63B600 or LMD63B600	600	JD6 [®]	JD63B300	300	FXD6 or JD6 [®]	FXD63B225 JD63B225	225 225
200	LMD6	LMD63B800	800	LMD6	LMD63B800	800	JD6 [®]	JD63B350	350	JD6 [®]	JD63B300	300
250	—	—	—	—	—	—	JD6 [®]	JD63B400	400	JD6 [®]	JD63B400	400
300	—	—	—	—	—	—	LD6 [®] or LMD6	LD63B600 or LMD63B600	600	JD6 [®]	JD63B400	400
350	—	—	—	—	—	—	LMD6	LMD63B700	700	LD6 [®] or LMD6	LD63B500 or LMD63B500	500
400	—	—	—	—	—	—	LMD6	LMD63B800	800	LD6 [®] or LMD6	LD63B600 or LMD63B600	600
500	—	—	—	—	—	—	—	—	—	LMD6	LMD63B800	800

①The selection of breakers for this table is in accordance with Article 430, 2005 National Electric Code. Recommended circuit breakers are for full voltage starting, special consideration is necessary for reduced voltage starting.

②For panelboard applications, substitute the BL breaker for the BQ, ED2 circuit breakers may also be used.

③For non-interchangeable trip applications, substitute the FXD6 for the FD6, the JXD6 for the JD6, or the LXD6 for the LD6.

Molded Case Circuit Breakers

Adjustable Installments Magnetic Trip Settings

Application

Breaker Type	Maximum Continuous Amperes	Nominal AC Adjustable Trip Range								ETI Motor Circuit Protector Catalog Number	Thermal Magnetic Catalog Number		
		Low	2	3	4	5	6	7	High		3-Pole	2-Pole	3-Pole
HEM	3	9	15	21	27	30	—	—	33	HEM3M003L	—	—	
	7	21	35	49	63	70	—	—	77	HEM3M007L	—	—	
	15	45	75	100	135	150	—	—	165	HEM3M015L	—	—	
	30	90	150	210	270	300	—	—	330	HEM3M030L	—	—	
	50	150	250	350	450	500	—	—	550	HEM3M050L	—	—	
	70	210	350	490	630	700	—	—	770	HEM3M070L	—	—	
	100	300	500	700	900	1000	—	—	1100	HEM3M100L	—	—	
ED6	1	2.6	4.5	6	7.5	—	—	—	9	ED63A001	—	—	
	2	7	11	15	19	—	—	—	22	ED63A002	—	—	
	3	10	17	23	30	—	—	—	35	ED63A003	—	—	
	5	16	26	36	46	—	—	—	54	ED63A005	—	—	
	10	30	50	70	85	—	—	—	100	ED63A010	—	—	
	25	55	90	125	155	—	—	—	180	ED63A025	—	—	
	30	80	135	185	235	—	—	—	270	ED63A030	—	—	
	40	115	185	255	325	—	—	—	375	ED63A040	—	—	
	50	180	300	410	520	—	—	—	600	ED63A050	—	—	
	100	315	540	740	890	—	—	—	1000	ED63A100	—	—	
	125	500	720	920	1100	—	—	—	1250	ED63A125	—	—	
	CED6	1	2.6	4.5	6	7.5	—	—	—	9	CED63A001■	—	—
2		7	11	15	19	—	—	—	22	CED63A002■	—	—	
3		10	17	23	30	—	—	—	35	CED63A003■	—	—	
5		16	26	36	46	—	—	—	54	CED63A005■	—	—	
10		30	50	70	85	—	—	—	100	CED63A010■	—	—	
25		55	90	125	155	—	—	—	180	CED63A025■	—	—	
30		80	135	185	235	—	—	—	270	CED63A030■	—	—	
40		115	185	255	325	—	—	—	375	CED63A040■	—	—	
50		180	300	410	520	—	—	—	600	CED63A050	—	—	
100		315	540	740	890	—	—	—	1000	CED63A100	—	—	
125		500	720	920	1100	—	—	—	1250	CED63A125	—	—	
FXD6-A		70	600	640	690	730	770	810	850	900	—	FXD62B070	FXD63B070
	80	600	640	690	730	770	810	850	900	—	FXD62B080	FXD63B080	
	90	600	640	690	730	770	810	850	900	—	FXD62B090	FXD63B090	
	100	700	770	840	920	990	1060	1140	1200	—	FXD62B100	FXD63B100	
	110	700	770	840	920	990	1060	1140	1200	—	FXD62B110	FXD63B110	
	125	800	900	1000	1100	1200	1300	1400	1500	—	FXD62B125	FXD63B125	
	150	400	460	520	580	640	700	760	820	—	FXD63L150	—	
	150	800	900	1000	1100	1200	1300	1400	1500	—	FXD63A150	FXD63B150	
	150	1100	1300	1500	1700	1900	2100	2300	2500	—	FXD63H150	—	
	175	900	1060	1210	1370	1520	1780	1930	2000	—	FXD62B175	FXD63B175	
	200	900	1060	1210	1370	1520	1780	1930	2000	—	FXD62B200	FXD63B200	
	225	1100	1300	1500	1700	1900	2100	2300	2500	—	FXD62B225	FXD63B225	
250	1100	1300	1500	1700	1900	2100	2300	2500	—	FXD62B250	FXD63B250		
FD6-A	70	600	640	690	730	770	810	850	900	—	FD62B070	FD63B070	
	80	600	640	690	730	770	810	850	900	—	FD62B080	FD63B080	
	90	600	640	690	730	770	810	850	900	—	FD62B090	FD63B090	
	100	700	770	840	920	990	1060	1140	1200	—	FD62B100	FD63B100	
	110	700	770	840	920	990	1060	1140	1200	—	FD62B110	FD63B110	
	125	800	900	1000	1100	1200	1300	1400	1500	—	FD62B125	FD63B125	
	150	800	900	1000	1100	1200	1300	1400	1500	—	FD62B150	FD63B150	
	175	900	1060	1210	1370	1520	1780	1930	2000	—	FD62B175	FD63B175	
	200	900	1060	1210	1370	1520	1780	1930	2000	—	FD62B200	FD63B200	
	225	1100	1300	1500	1700	1900	2100	2300	2500	—	FD62B225	FD63B225	
	250	1100	1300	1500	1700	1900	2100	2300	2500	—	FD62B250	FD63B250	
	HFD6	70	600	640	690	730	770	810	850	900	—	HFD62B070	HFD63B070
80		600	640	690	730	770	810	850	900	—	HFD62B080	HFD63B080	
90		600	640	690	730	770	810	850	900	—	HFD62B090	HFD63B090	
100		700	770	840	920	990	1060	1140	1200	—	HFD62B100	HFD63B100	
110		700	770	840	920	990	1060	1140	1200	—	HFD62B110	HFD63B110	
125		800	900	1000	1100	1200	1300	1400	1500	—	HFD62B125	HFD63B125	
150		800	900	1000	1100	1200	1300	1400	1500	—	HFD62B150	HFD63B150	
175		900	1060	1210	1370	1520	1780	1930	2000	—	HFD62B175	HFD63B175	
200		900	1060	1210	1370	1520	1780	1930	2000	—	HFD62B200	HFD63B200	
225		1100	1300	1500	1700	1900	2100	2300	2500	—	HFD62B225	HFD63B225	
250		1100	1300	1500	1700	1900	2100	2300	2500	—	HFD62B250	HFD63B250	
HHFD6		70	600	640	690	730	770	810	850	900	—	HHFD63B070	HHFD63B070
	80	600	640	690	730	770	810	850	900	—	HHFD63B080	HHFD63B080	
	90	600	640	690	730	770	810	850	900	—	HHFD63B090	HHFD63B090	
	100	700	770	840	920	990	1060	1140	1200	—	HHFD63B100	HHFD63B100	
	110	700	770	840	920	990	1060	1140	1200	—	HHFD63B110	HHFD63B110	
	125	800	900	1000	1100	1200	1300	1400	1500	—	HHFD63B125	HHFD63B125	
	150	800	900	1000	1100	1200	1300	1400	1500	—	HHFD63B150	HHFD63B150	
	175	900	1060	1210	1370	1520	1780	1930	2000	—	HHFD63B175	HHFD63B175	
	200	900	1060	1210	1370	1520	1780	1930	2000	—	HHFD63B200	HHFD63B200	
	225	1100	1300	1500	1700	1900	2100	2300	2500	—	HHFD63B225	HHFD63B225	
	250	1100	1300	1500	1700	1900	2100	2300	2500	—	HHFD63B250	HHFD63B250	
	CFD6	70	600	640	690	730	770	810	850	900	—	CFD62B070	CFD63B070
80		600	640	690	730	770	810	850	900	—	CFD62B080	CFD63B080	
90		600	640	690	730	770	810	850	900	—	CFD62B090	CFD63B090	
100		700	770	840	920	990	1060	1140	1200	—	CFD62B100	CFD63B100	
110		700	770	840	920	990	1060	1140	1200	—	CFD62B110	CFD63B110	
125		800	900	1000	1100	1200	1300	1400	1500	—	CFD62B125	CFD63B125	
150		400	460	520	580	640	700	760	820	—	CFD63L150	—	
150		800	900	1000	1100	1200	1300	1400	1500	—	CFD63A150	CFD63B150	
150		1100	1300	1500	1700	1900	2100	2300	2500	—	CFD63H150	—	
175		900	1060	1210	1370	1520	1780	1930	2000	—	CFD62B175	CFD63B175	
200		900	1060	1210	1370	1520	1780	1930	2000	—	CFD62B200	CFD63B200	
225		1100	1300	1500	1700	1900	2100	2300	2500	—	CFD62B225	CFD63B225	
250	1100	1300	1500	1700	1900	2100	2300	2500	—	CFD62B250	CFD63B250		

Note: Tolerances for instantaneous trip points meet UL 489 (7.3). Nominal AC instantaneous trip points are given in the tables. For DC instantaneous trip points, add 15% to nominal values.

Instantaneous trip adjustment is made through the breaker cover on all frame breakers. To change instantaneous trip point on circuit breaker, depress indicating knob, then rotate to desired position.

■ Built to order. Allow 2-3 weeks for delivery.

7
MOLDED CASE
CIRCUIT BREAKERS

Molded Case Circuit Breakers

Adjustable Instantaneous Magnetic Trip Settings

Application

Breaker Type	Maximum Continuous Amperes	Nominal AC Adjustable Trip Range								ETI Motor Circuit Protector Catalog Number		Thermal Magnetic Catalog Number		
		Low	2	3	4	5	6	7	High	3-Pole	2-Pole	3-Pole		
JXD2(A)	200	1250	1430	1610	1790	1960	2140	2320	2500	—	JXD22B200	JXD23B200		
	225	1250	1430	1610	1790	1960	2140	2320	2500	—	JXD22B225	JXD23B225		
	250	1250	1430	1610	1790	1960	2140	2320	2500	—	JXD22B250	JXD23B250		
	300	1250	1430	1610	1790	1960	2140	2320	2500	—	JXD22B300	JXD23B300		
	350	2000	2290	2570	2860	3140	3430	3710	4000	—	JXD22B350	JXD23B350		
	400	2000	2290	2570	2860	3140	3430	3710	4000	—	JXD22B400	JXD23B400		
JXD6(A)	200	1250	1430	1610	1790	1960	2140	2320	2500	—	JXD62B200	JXD63B200		
	225	1250	1430	1610	1790	1960	2140	2320	2500	—	JXD62B225	JXD63B225		
	250	1250	1430	1610	1790	1960	2140	2320	2500	—	JXD62B250	JXD63B250		
	300	1250	1430	1610	1790	1960	2140	2320	2500	—	JXD62B300	JXD63B300		
	350	2000	2290	2570	2860	3140	3430	3710	4000	—	JXD62B350	JXD63B350		
	400	2000	2290	2570	2860	3140	3430	3710	4000	—	JXD62B400	JXD63B400		
JD6(A)	200	1250	1430	1610	1790	1960	2140	2320	2500	—	JD62B200	JD63B200		
	225	1250	1430	1610	1790	1960	2140	2320	2500	—	JD62B225	JD63B225		
	250	1250	1430	1610	1790	1960	2140	2320	2500	—	JD62B250	JD63B250		
	300	1250	1430	1610	1790	1960	2140	2320	2500	—	JD62B300	JD63B300		
	350	2000	2290	2570	2860	3140	3430	3710	4000	—	JD62B350	JD63B350		
	400	2000	2290	2570	2860	3140	3430	3710	4000	JXD63L400 JXD63H400	JD62B400	JD63B400		
HJD6(A)	200	1250	1430	1610	1790	1960	2140	2320	2500	—	HJD62B200	HJD63B200		
	225	1250	1430	1610	1790	1960	2140	2320	2500	—	HJD62B225	HJD63B225		
	250	1250	1430	1610	1790	1960	2140	2320	2500	—	HJD62B250	HJD63B250		
	300	1250	1430	1610	1790	1960	2140	2320	2500	—	HJD62B300	HJD63B300		
	350	2000	2290	2570	2860	3140	3430	3710	4000	—	HJD62B350	HJD63B350		
	400	2000	2290	2570	2860	3140	3430	3710	4000	—	HJD62H400	HJD63B400		
HHJD6	200	1250	1430	1610	1790	1960	2140	2320	2500	—	HHJD62B200	HHJD63B200		
	225	1250	1430	1610	1790	1960	2140	2320	2500	—	HHJD62B225	HHJD63B225		
	250	1250	1430	1610	1790	1960	2140	2320	2500	—	HHJD62B250	HHJD63B250		
	300	1250	1430	1610	1790	1960	2140	2320	2500	—	HHJD62B300	HHJD63B300		
	350	2000	2290	2570	2860	3140	3430	3710	4000	—	HHJD62B350	HHJD63B350		
	400	2000	2290	2570	2860	3140	3430	3710	4000	—	HHJD62B400	HHJD63B400		
CJD6	200	1250	1430	1610	1790	1960	2140	2320	2500	—	—	CJD63B200		
	225	1250	1430	1610	1790	1960	2140	2320	2500	—	—	CJD63B225		
	250	1250	1430	1610	1790	1960	2140	2320	2500	—	—	CJD63B250		
	300	1250	1430	1610	1790	1960	2140	2320	2500	—	—	CJD63B300		
	350	2000	2290	2570	2860	3140	3430	3710	4000	—	—	CJD63B350		
	400	2000	2290	2570	2860	3140	3430	3710	4000	CJD63H400 CJD63L400	—	CJD63B400		
LXD6(A)	450	2000	2290	2570	2860	3140	3430	3710	4000	—	LXD62B450	LXD63B450		
	500	3000	3430	3860	4290	4710	5140	5570	6000	—	LXD62B500	LXD63B500		
	600	3000	3430	3860	4290	4710	5140	5570	6000	—	LXD62B600	LXD63B600		
LD6(A)	250	1250	1430	1610	1790	1960	2140	2320	2500	—	LD62B250	LD63B250		
	300	1250	1430	1610	1790	1960	2140	2320	2500	—	LD62B300	LD63B300		
	350	2000	2290	2570	2860	3140	3430	3710	4000	—	LD62B350	LD63B350		
	400	2000	2290	2570	2860	3140	3430	3710	4000	—	LD62B400	LD63B400		
	450	2000	2290	2570	2860	3140	3430	3710	4000	—	LD62B450	LD63B450		
	500	3000	3430	3800	4290	4710	5140	5570	6000	—	LD62B500	LD63B500		
HLD6(A)	250	1250	1430	1610	1790	1960	2140	2320	2500	—	HLD62B250	HLD63B250		
	300	1250	1430	1610	1790	1960	2140	2320	2500	—	HLD62B300	HLD63B300		
	350	2000	2290	2570	2860	3140	3430	3710	4000	—	HLD62B350	HLD63B350		
	400	2000	2290	2570	2860	3140	3430	3710	4000	—	HLD62B400	HLD63B400		
	450	2000	2290	2570	2860	3140	3430	3710	4000	—	HLD62B450	HLD63B450		
	500	3000	3430	3860	4290	4710	5140	5570	6000	—	HLD62B500	HLD63B500		
HHLD6	250	1250	1430	1610	1790	1960	2140	2320	2500	—	HHLD62B250	HHLD63B250		
	300	1250	1430	1610	1790	1960	2140	2320	2500	—	HHLD62B300	HHLD63B300		
	350	2000	2290	2570	2860	3140	3430	3710	4000	—	HHLD62B350	HHLD63B350		
	400	2000	2290	2570	2860	3140	3430	3710	4000	—	HHLD62B400	HHLD63B400		
	450	2000	2290	2570	2860	3140	3430	3710	4000	—	HHLD62B450	HHLD63B450		
	500	3000	3430	3860	4290	4710	5140	5570	6000	—	HHLD62B500	HHLD63B500		
CLD6	250	1250	1430	1610	1790	1960	2140	2320	2500	—	—	CJD63B250		
	300	1250	1430	1610	1790	1960	2140	2320	2500	—	—	CJD63B300		
	350	2000	2290	2570	2860	3140	3430	3710	4000	—	—	CJD63B350		
	400	2000	2290	2570	2860	3140	3430	3710	4000	—	—	CLD63B400		
	450	2000	2290	2570	2860	3140	3430	3710	4000	—	—	CLD63B450		
	500	3000	3430	3860	4290	4710	5140	5570	6000	—	—	CLD63B500		
LMXD6	500	3000	3430	3860	4290	4710	5140	5570	6000	—	—	LMXD63B500		
	600	3000	3430	3860	4290	4710	5140	5570	6000	—	—	LMXD63B600		
	700	3200	3500	3700	4200	4700	6400	7300	8000	—	—	LMXD63B700		
	800	2800	3100	3400	3700	4000	4800	5500	6000	—	—	LMXD63B800		
	800	3200	3500	3700	4200	4700	6400	7300	8000	LMXD63L800 LMXD63A800	LMXD62B800	LMXD63B800		
	800	3200	3500	3700	4200	4700	6400	7300	8000	—	—	LMXD63B800		
LMD6	500	3000	3430	3860	4290	4710	5140	5570	6000	—	LMD62B500	LMD63B500		
	600	3000	3430	3860	4290	4710	5140	5570	6000	—	LMD62B600	LMD63B600		
	700	3200	3500	3700	4200	4700	6400	7300	8000	—	LMD62B700	LMD63B700		
	800	3200	3500	3700	4200	4700	6400	7300	8000	—	LMD62B800	LMD63B800		

MOLDED CASE
CIRCUIT BREAKERS
7

Molded Case Circuit Breakers

Adjustable Instantaneous Magnetic Trip Settings

Application

Breaker Type	Maximum Continuous Amperes	Nominal AC Adjustable Trip Range								ETI Motor Circuit Protector Catalog Number	Thermal Magnetic Catalog Number		
		Low	2	3	4	5	6	7	High	3-Pole	2-Pole	3-Pole	
HLMXD6	500	3000	3430	3860	4290	4710	5140	5570	6000	—	—	HLMXD63B500	
	600	3000	3430	3860	4290	4710	5140	5570	6000	—	—	HLMXD63B600	
	700	3200	3500	3700	4200	4700	6400	7300	8000	—	—	HLMXD63B700	
	800	3200	3500	3700	4200	4700	6400	7300	8000	—	—	HLMXD63B800	
HLMD6	500	3000	3430	3860	4290	4710	5140	5570	6000	—	HLMD62B500	HLMD63B500	
	600	3000	3430	3860	4290	4710	5140	5570	6000	—	HLMD62B600	HLMD63B600	
	700	3200	3500	3700	4200	4700	6400	7300	8000	—	HLMD62B700	HLMD63B700	
	800	3200	3500	3700	4200	4700	6400	7300	8000	—	HLMD62B800	HLMD63B800	
MD6	500	3000	3430	3860	4290	4710	5140	5570	6000	—	—	MD63B500	
	600	3000	3430	3860	4290	4710	5140	5570	6000	—	—	MD63B600	
	700	4000	4570	5140	5710	6280	6850	7420	8000	—	—	MD63B700	
	800	3000	3430	3860	4280	4710	5140	5570	6000	MXD63L800	—	—	
	800	4000	4570	5140	5710	6280	6850	7420	8000	MXD63A800	—	MD63B800	
	800	5000	5715	6430	7145	7860	8575	9290	10000	MXD63H800	—	—	
MXD6	500	3000	3430	3860	4280	4710	5140	5570	6000	—	MXD62B500	MXD63B500	
	600	3000	3430	3860	4280	4710	5140	5570	6000	—	MXD62B600	MXD63B600	
	700	4000	4570	5140	5710	6280	6850	7420	8000	—	MXD62B700	MXD63B700	
	800	3000	3430	3860	4280	4710	5140	5570	6000	MXD63L800	—	—	
	800	4000	4570	5140	5710	6280	6850	7420	8000	MXD63A800	—	MXD63B800	
	800	5000	5715	6430	7145	7860	8575	9290	10000	MXD63H800	—	—	
HMD6	500	3000	3430	3860	4280	4710	5140	5570	6000	—	HMD62B500	HMD63B500	
	600	3000	3430	3860	4280	4710	5140	5570	6000	—	HMD62B600	HMD63B600	
	700	4000	4570	5140	5710	6280	6850	7420	8000	—	HMD62B700	HMD63B700	
	800	4000	4570	5140	5710	6280	6850	7420	8000	—	HMD62B800	HMD63B800	
HMXD6	500	3000	3430	3860	4280	4710	5140	5570	6000	—	—	HMXD63B500	
	600	3000	3430	3860	4280	4710	5140	5570	6000	—	—	HMXD63B600	
	700	4000	4570	5140	5710	6280	6850	7420	8000	—	—	HMXD63B700	
	800	4000	4570	5140	5710	6280	6850	7420	8000	—	—	HMXD63B800	
CMD6	400	3000	3430	3860	4280	4710	5140	5570	6000	—	—	—	
	500	3000	3430	3860	4280	4710	5140	5570	6000	—	—	—	
	600	3000	3430	3860	4280	4710	5140	5570	6000	—	—	—	
	700	4000	4570	5140	5710	6280	6850	7420	8000	—	—	CMD63B600	
	800	3000	3430	3860	4280	4710	5140	5570	6000	CMD63L800	—	CMD63B700	
	800	4000	4570	5140	5710	6280	6850	7420	8000	CMD63A800	—	CMD63B800	
ND6	800	4000	4570	5140	5710	6280	6850	7420	8000	—	ND62B800	ND63B800	
	900	5000	5715	6430	7145	7860	8575	9290	10000	—	ND62B900	ND63B900	
	1000	5000	5715	6430	7145	7860	8575	9290	10000	—	ND62B100	ND63B100	
	1200	5000	5715	6430	7145	7860	8575	9290	10000	—	ND62B120	ND63B120	
	NXD6	900	5000	5715	6430	7145	7860	8575	9290	10000	—	NXD62B900	NXD63B900
		1000	5000	5715	6430	7145	7860	8575	9290	10000	—	NXD62B100	NXD63B100
1200		5000	5715	6430	7145	7860	8575	9290	10000	—	NXD62B120	NXD63B120	
HND6		800	4000	4570	5140	5710	6280	6850	7420	8000	—	HND62B800	HND63B800
		900	5000	5715	6430	7145	7860	8575	9290	10000	—	HND62B900	HND63B900
		1000	5000	5715	6430	7145	7860	8575	9290	10000	—	HND62B100	HND63B100
	1200	5000	5715	6430	7145	7860	8575	9290	10000	—	HND62B120	HND63B120	
HNXD6	900	5000	5715	6430	7145	7860	8575	9290	10000	—	—	HNXD63B900	
	1000	5000	5715	6430	7145	7860	8575	9290	10000	—	—	HNXD63B100	
	1200	5000	5715	6430	7145	7860	8575	9290	10000	—	—	HNXD63B120	
CND6	800	4000	4570	5140	5710	6280	6850	7420	8000	—	—	CND63B800	
	900	5000	5715	6430	7145	7860	8575	9290	10000	—	—	CND63B900	
	1000	5000	5715	6430	7145	7860	8575	9290	10000	—	—	CND63B100	
	1200	5000	5715	6430	7145	7860	8575	9290	10000	—	—	CND63B120	
PD6	1200	5000	5715	6430	7145	7860	8575	9290	10000	—	—	PD63B120	
	1400	5000	5715	6430	7145	7860	8575	9290	10000	—	—	PD63B140	
	1600	5000	5715	6430	7145	7860	8575	9290	10000	—	—	PD63B160	
PXD6	1200	5000	5715	6430	7145	7860	8575	9290	10000	—	—	PXD63B120	
	1400	5000	5715	6430	7145	7860	8575	9290	10000	—	—	PXD63B140	
	1600	5000	5715	6430	7145	7860	8575	9290	10000	—	—	PXD63B160	
HPD6	1200	5000	5715	6430	7145	7860	8575	9290	10000	—	—	HPD63B120	
	1400	5000	5715	6430	7145	7860	8575	9290	10000	—	—	HPD63B140	
	1600	5000	5715	6430	7145	7860	8575	9290	10000	—	—	HPD63B160	
HPXD6	1200	5000	5715	6430	7145	7860	8575	9290	10000	—	—	HPXD63B120	
	1400	5000	5715	6430	7145	7860	8575	9290	10000	—	—	HPXD63B140	
	1600	5000	5715	6430	7145	7860	8575	9290	10000	—	—	HPXD63B160	
CPD6	1200	5000	5715	6430	7145	7860	8575	9290	10000	—	—	CPD63B120	
	1400	5000	5715	6430	7145	7860	8575	9290	10000	—	—	CPD63B140	
	1600	5000	5715	6430	7145	7860	8575	9290	10000	—	—	CPD63B160	
RD6	1800	5000	5715	6430	7145	7860	8575	9290	10000	—	—	RD63B180	
	2000	5000	5715	6430	7145	7860	8575	9290	10000	—	—	RD63B200	
RXD6	1800	5000	5715	6430	7145	7860	8575	9290	10000	—	—	RXD63B180	
	2000	5000	5715	6430	7145	7860	8575	9290	10000	—	—	RXD63B200	
HRD6	1800	5000	5715	6430	7145	7860	8575	9290	10000	—	—	HRD63B180	
	2000	5000	5715	6430	7145	7860	8575	9290	10000	—	—	HRD63B200	
HRXD6	1800	5000	5715	6430	7145	7860	8575	9290	10000	—	—	HRXD63B180	
	2000	5000	5715	6430	7145	7860	8575	9290	10000	—	—	HRXD63B200	

MOLDED CASE
CIRCUIT BREAKERS

Molded Case Circuit Breakers

Molded Case Switch — Circuit Disconnect

Selection

Maximum Frame Amp Rating	2-Pole	3-Pole	Self-Protective Instantaneous Override $\pm 20\%$ ^③
	Catalog Number	Catalog Number	
100	BQ2S060■	BQ3S060■	1000
	BQ2S100■	BQ3S100■	1000
125	ED22S100A■	ED23S100A	1000
	ED42S100A■	ED43S100A	1000
	ED42S125A■	ED43S125A	1000
	ED62S100A■	ED63S100A	1000
	—	ED63S125A	1000
	CED62S100A■	CED63S100A■	1000
	CED62S125A■	CED63S125A■	1000
	—	HES3S100L	1250
	—	HES3S125L	1250
	225	—	HQR23S250HA
250	FXD62S250A	FXD63S250A	3200
	HFXD62S250A■	HFXD63S250A■	3200
	①	CFD63S250A■	3200
400	JXD22S400A■	JXD23S400A	6000
	—	JXD63S400A	6000
	—	HJXD63S400A■	6000
	①	CJD63S400A■	6000
600	—	LXD63S600A	6000
	—	HLXD63S600A■	6000
	①	CLD63S600A■	6000
800	—	LMXD63S800A■	8000
	—	MXD63S800A	8000
	①	CMD63S800A	8000
1200	—	NXD63S120A	10000
	①	CND63S120A■	10000
1600	①	PXD63S160A ^②	10000
2000	①	RXD63S200A■ ^③	10000

Ordering Information

Order by catalog number. Switches include frame and self protective trip unit only. Order lugs separately from pages 7-87 to 7-89.

■ Built to order. Allow 2–3 weeks for delivery.

① For 2-pole application use outside poles of 3-pole circuit breaker.

② For additional lugs see pages 7-87 to 7-89.

③ Molded case switches up to R frame contain a self protecting instantaneous element, which may open circuit above their override set point.

④ UL file E57556 Volume 1, section 2 and CSA LR 42022-51.

⑤ Requires mounting block MB9301 or MBR9302.

Lugs pages 7-87 to 7-89
Enclosures Section 6
Accessories pages 7-94 to 7-99

Molded Case Circuit Breakers

Digital Solid State Sentron Sensitrip IV Series

Technical

The Sentron Sensitrip IV circuit breaker is a true RMS current sensing device. Digital microprocessor circuitry within the electronic trip unit provides more precise control over the circuit breaker functions. This control allows circuit coordination flexibility not available with thermal magnetic circuit breakers.

Functions available in Sentron Sensitrip circuit breakers

Catalog Number Suffix	Trip Type	Cont Current Setting	Long Time Delay	Instantaneous Pickup	Short Time Pickup	Short Time Fixed Delay	Short Time I ² t Delay	Ground Fault Pickup	Ground Fault Delay
LI	LI	✓	✓	✓					
LIG	LIG	✓	✓	✓				✓	✓
LSI	LSI	✓	✓	✓	✓	✓	✓		
LSIG	LSIG	✓	✓	✓	✓	✓	✓	✓	✓

Typical Trip Unit Labeling and Adjustment Positions for the Sentron Sensitrip Circuit Breaker.

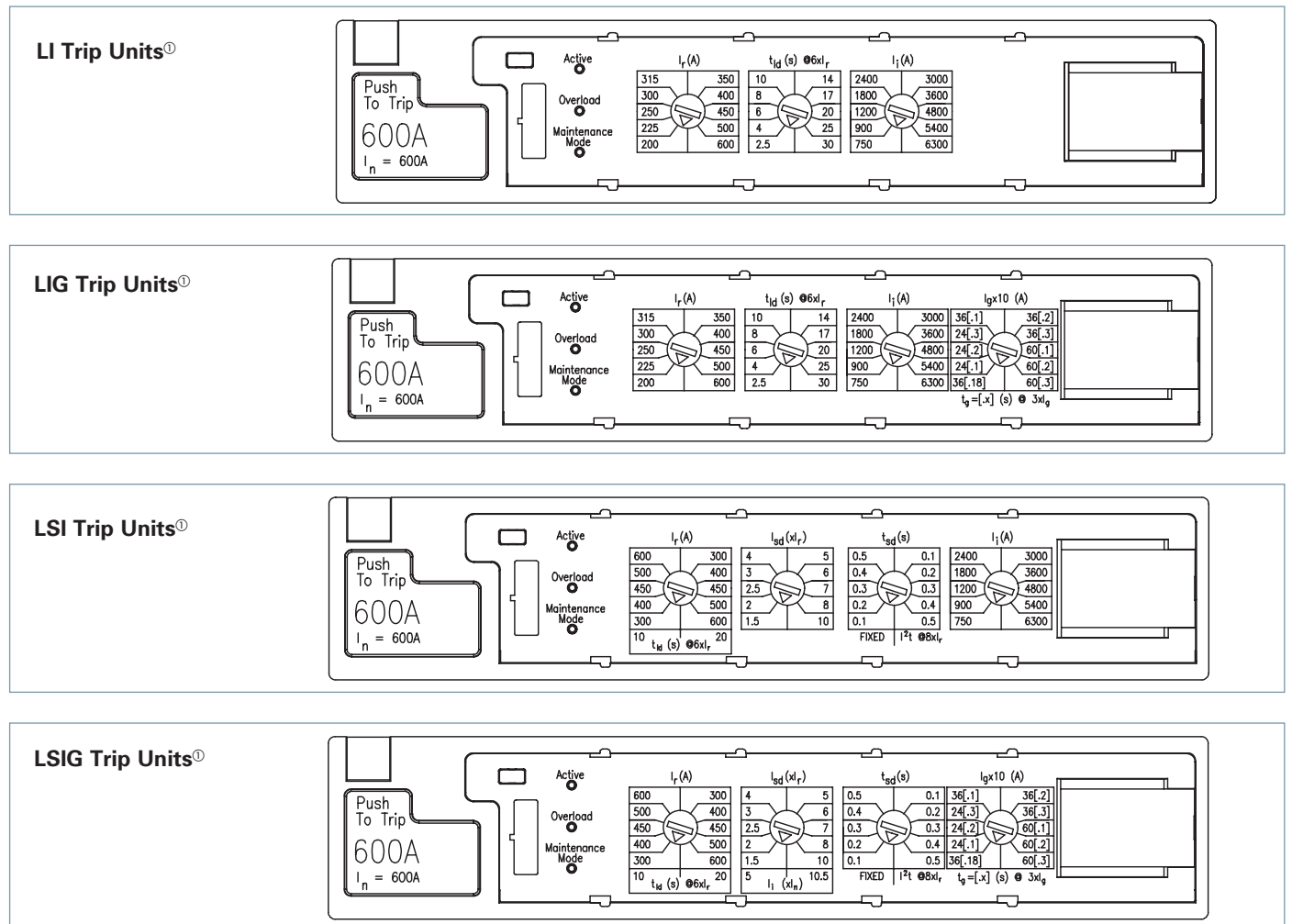

- I_n = Maximum circuit breaker ampere rating
- I_r = Continuous current rating expressed in amperes
- I_i = Instantaneous pickup expressed in amperes
- I_{sd} = Short time pickup expressed in multiples of I_r

- I_g = Ground fault pickup expressed in amperes
- t_{sd} = Short time delay - either fixed or I^2t time delay function
- t_{ld} = Long time delay - I^2t time delay function
- t_g = Ground fault delay - I^2t time delay function

NOTE: Frame rating (I_n) of 600A shown as an example. Trip unit settings will vary based on the specific frame rating (I_n) of the device.

① Schematic of advanced trip unit shown. Basic trip units are identical but do not include DAS / Maintenance Mode functionality.

7
MOLDED CASE
CIRCUIT BREAKERS

Molded Case Circuit Breakers

Digital Solid State Sentron Sensitrip IV Series

Technical

A. Adjustable "Continuous Amps" Rating Switch
All Sensitrip IV solid state molded case circuit breakers have an adjustable ampere rating switch. Adjustments made to this switch change the continuous current rating of the breaker.

B. Adjustable "Long Time Delay" Switch
All Sensitrip IV circuit breakers have an adjustable long time delay switch to allow for selection of long time delays of fixed time intervals at six times the setting of the adjustable "continuous amps" rating switch.

C. Adjustable "Instantaneous Pick-Up" Switch
Sensitrip IV circuit breakers with an adjustable instantaneous pick up switch allow selection of a specific instantaneous trip setting.

D. Adjustable "Short Time Pick-Up" Switch (Optional)
Sensitrip IV circuit breakers with an adjustable short time pick-up switch allow for selection of short time pick-up in a range from 1.5 to 10 times the setting of the maximum current rating.

E. Adjustable "Short Time Delay" Switch (Optional)
Sensitrip IV circuit breakers with an adjustable short time delay switch also contain a switch for adjustment in time delay. The adjustable short time delay switch allows for either of two modes of short time delays. One range of settings enables the breaker to be set for fixed time delays and the other range of settings enables the breaker to be set for short time delays based on I²t curves.

Adjustable "Ground Fault Pick-Up" Switch
Sensitrip IV circuit breakers containing the optional equipment ground fault protection have a ground fault pick-up setting. The ground fault pick-up settings allow for one of three time delays based on I²t curves.
For 3-phase, 4-wire systems, an external neutral transformer is required with an ampere rating equal to the trip unit ampere rating.

Ground Fault Pick-up (I_g)
Ground Fault Delay @ I²T @ 3 x I_g (t_g)

Legend:
I_n = Maximum circuit breaker ampere rating
I_r = Continuous current rating expressed in amperes
I_i = Instantaneous pickup expressed in amperes
I_{sd} = Short time pickup expressed in multiples of I_r
I_g = Ground fault pickup expressed in amperes
t_{sd} = Short time delay - either fixed or I²t time delay function
t_{ld} = Long time delay - I²t time delay function
t_g = Ground fault delay - I²t time delay function

Examples of Adjustment Settings

Catalog Number SLD6A600LI

	Frame Rating (I _n)	Switch 1 Continuous Current Setting (I _r)	Switch 2 Long Time Delay Setting (t _{ld})	Switch 3 Instantaneous Pickup Setting (I _i)
Setting	600A	200	2.5	750
Description	600A max current rating	200A	2.5 sec to trip @ 6 x I _r [6 x 200A = 1200A]	750A

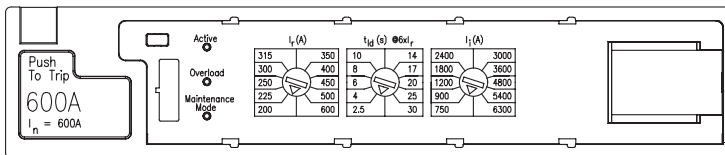

Catalog Number SLD6A600LSIG

	Frame Rating (I _n)	Switch 1		Switch 2		Switch 3	Switch 4	
		Cont. Current Setting (I _r)	Long Time Delay Setting (t _{ld})	Short Time Pickup Setting (I _{sd})	Instantaneous Pickup Setting (I _i)	Short Time Delay Setting (t _{sd})	Ground Fault Pickup Setting (I _g)	Ground Fault Delay Setting (t _g)
Setting	600A	300	10	1.5	5	0.1	36 [.18]	36 [.18]
Description	600A max current rating	300A	10 sec @ 6 x I _r [6 x 300A = 1800A]	1.5 x I _r [1.5 x 200A = 300A]	5 x I _n [5 x 600A = 3,000A]	0.1 sec	I _g = 36 x 10 [36 x 10 = 360A]	0.18 sec @ 3 x I _g [3 x 360 = 1,080A]

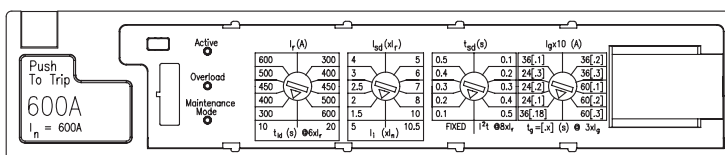

7
MOLDED CASE
CIRCUIT BREAKERS

Breaker Description

The ever-increasing use of plant and energy management systems has intensified the demand for circuit breakers supporting multiple open protocols to monitor and control the flow of energy in the power system. The extensive and modular WL family of circuit breakers and accessories provides this for applications from 200A to 6000A.

Applications

WL breakers can be applied as main, tie, feeder or distribution breakers in low-voltage electrical power systems.

Versions

- Frame ratings: 800A to 6000A
- 3 physical frame sizes
- Rated nominal operating voltage up to 635VAC
- Seven interrupting classes from 50kA to 200kA at 480V
- Circuit breaker or non-automatic switch
- WL Circuit Breakers are delivered as complete assembled breakers or individual frames, guide frames, and accessories

Installation Types

Fixed-mounted or Draw-out version.

Standards

- WL ANSI / UL 1066 Circuit Breakers will satisfy: C37.13, C37.16, C37.17, C37.50, NEMA SG3
- WL UL 489 Circuit Breakers will satisfy: UL 489
- WL Circuit Breakers are suitable for use in UL 1558 LV Switchgear and UL 891 LV Switchboards

Conditions of Application

WL Circuit Breakers are designed to meet standard Industrial and Commercial application requirements.

Uniform Dimensions

WL Circuit Breaker dimensions differ only in the device width, which varies by frame size. With the exception of the 200kA ANSI Frame Size II which has an additional 5" in depth to accommodate integral fuses and the UL489 Frame Size I which measures only 15" in height to allow six-high stacking in switchboards.

Minimal Space Requirements

The WL design is extremely compact without sacrificing performance and does not use energy-wasting heat sinks.

Trip Units

The electronic, micro processor-based trip unit is auxiliary voltage-independent for all protective functions and enables adaptation to the different protection requirements of distribution systems, motors, transformers and generators.

Non-Automatic Switch

A special version of the circuit breaker is used as a non-automatic switch.

The non-automatic switch is constructed without a trip unit and has no protective function. A possible application is for use as a tie in systems with parallel feeds.

Main Bus Connectors

Breakers are equipped with standard vertical main bus connections. Horizontal bus connections are available as an option in Frame Size 1 and 2 up to 2000A.

Communication Capability

MODBUS or PROFIBUS communications transmit the acquired and metered data, such as current values, breaker status, trip log, etc. to a central monitoring computer. With a factory installed metering function option, the WL acquires data useful for power management and can contribute to a significant savings in energy costs. A new, internal circuit breaker bus enables the expansion of breaker functionality through the integration of many secondary functions which were previously separate, including:

- Control of analog displays
- Options for testing the communication setup
- Display of breaker status and reason for trip
- Input modules for reading other external signals and transmitting these signals via PROFIBUS or MODBUS communication
- A selection of output modules to provide contact closures based on events or measured-value setpoints. It is not only possible to monitor the breaker remotely, it is also possible to open and close the breaker as well as setting parameters remotely

Operating Mechanisms

Circuit breakers can be optionally delivered with different operating mechanisms, including:

- Manual operating mechanism with mechanical closing (standard)

- Manual operating mechanism with mechanical and electrically interlocked closing
- Motorized operating mechanism with mechanical and electrically interlocked closing. Operating mechanisms with electrically interlocked closing are suitable for synchronizing tasks

Auxiliary Contacts

Auxiliary switches can be added according to the type of installation. They are easily mounted via front, top mounted terminal blocks.

Modularity

Common guide frames for the draw-out version make them completely interchangeable between the UL 489 and ANSI / UL 1066 rated circuit breakers. Components, such as auxiliary releases, motorized operating mechanisms, trip units, current sensors, auxiliary signal switches, automatic reset devices or interlocks can be used to modify or retrofit any circuit breaker to meet changing requirements. The main contacts can be replaced to extend the life of the circuit breaker and feature integrated contact wear indicators.

Electronic Trip Unit Modularity

Modularity is the outstanding feature of the new WL Circuit Breakers. The trip units themselves can be retrofitted with special LCDs, ground fault modules, rating plugs and communication modules. 100% Rated Circuit Breaker WL circuit breakers are designed for continuous operation at 100% of their current rating without the need for external heat sinks.

Conditions of Application

WL Circuit Breakers are designed to meet standard Industrial and Commercial application requirements.



WL Power Circuit Breakers

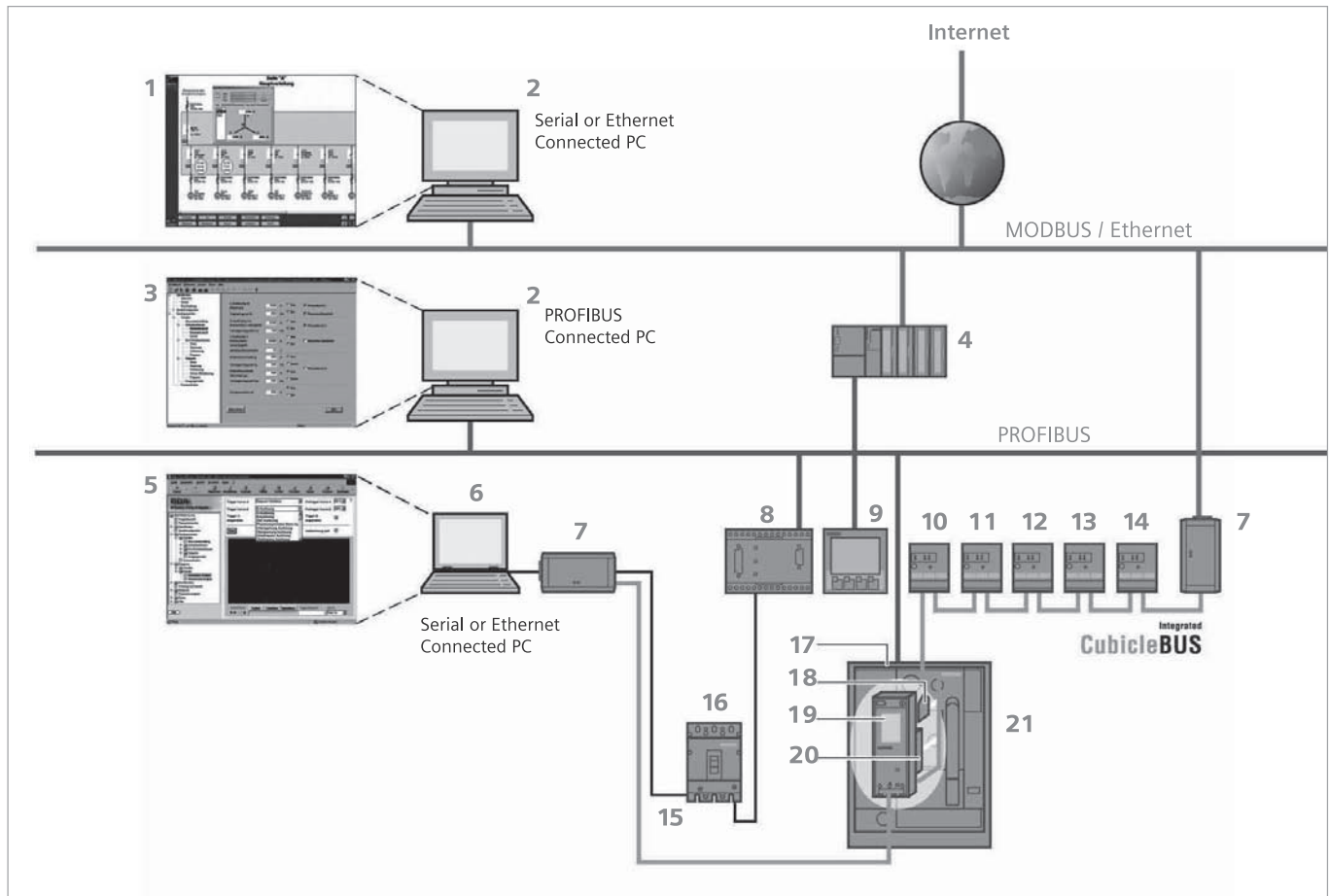

A spectrum of power distribution communication

- | | |
|---|--|
| <ul style="list-style-type: none"> 1 WinPM.Net software 2 Server or desktop PC 3 Switch ES power software 4 PLC 5 BDA web server 6 Portable PC 7 Breaker data adapter (BDA) 8 COM10 PROFIBUS module or COM11 MODBUS module 9 Power metering device 10 Zone selective interlock 11 Digital input module | <ul style="list-style-type: none"> 12 Analog output module 13 Digital output module 14 Relay output module 15 VL CubicleBus network 16 VL feeder breaker 17 Input power and communication terminals 18 Breaker status sensor (BSS) 19 Trip unit display 20 Metering function 21 WL power breaker |
|---|--|

WL Power Circuit Breakers

Electronic Trip Units

General



Trip Unit Functions

Basic Protective Functions		ETU745	ETU748	ETU776
Long-time overcurrent protection	L	●	●	●
Short-time delayed overcurrent protection	S	●	●	●
Instantaneous overcurrent protection	I	●	●	●
Neutral conductor protection	N	●	●	●
Ground fault protection	G	○	○	○
Additional Functions				
Selectable neutral protection		●	●	●
Defeatable short-time protection		●	—	●
Defeatable instantaneous protection		●	—	●
Selectable thermal memory		●	●	●
Zone selective interlocking		●	●	●
Selectable I2t or fixed short-time delay		●	●	●
Adjustable instantaneous pick-up		●	—	●
Selectable I2t or I4t long-time delay		●	●	●
Adjustable short-time delay and pick-up		●	●	●
Selectable and adjustable neutral protection		●	●	●
Dual protective setting capability		—	—	●
Dynamic arc-flash sentry		—	—	●
Extended instantaneous protection		●	●	●
Parameterization and Displays				
Parameterization by rotary switches (10 steps)		●	●	—
Parameterization by communication (absolute values)		—	●	●
Parameterization by menu/keypad (absolute values)		—	—	●
Remote parameterization of the basic functions		—	—	●
Remote parameterization of the additional functions		—	—	●
Alphanumeric LCD		○	○	—
Graphical LCD		—	—	●
Metering Function				
Metering function		○	○	○
Metering function Plus		○	○	○
Communication				
CubicleBUS		●	●	●
Communication via PROFIBUS-DP		○	○	○
Communication via the MODBUS		○	○	○
Communication via the Ethernet (BDA)		○	○	○

● Standard — Not available ○ Optional

Rating Plug

It is no longer necessary to replace the current transformer to change the rated current of the breaker. Instead, you simply replace the rating plug which is easily accessible on the front of the trip unit. The circuit breaker is set to the new rated current quickly and is already correctly labeled.

Long Time Overcurrent Protection with Switchable I2t/I4t Characteristics

The long time overcurrent protection in the ETU745, ETU755 and ETU776 trip units can be switched between an I2t and I4t characteristic to improve coordination between upstream circuit breakers and fuses.

Front Panel

The front panel is designed so that it can be accessed through a cutout in the door, which means that all controls and displays are accessible even when the cubicle door is closed. The front panels of all Frame Size II and Frame Size III circuit breakers are identical, and allow for two different through-door access designs: Trip unit and front panel controls or front panel controls only. The degree of protection of the front panel is IP 20.

Environmental Protection

The plastics used are halogen-free and recyclable.

Safety and Reliability

In order to help protect the electrical distribution system and circuit breaker against unauthorized breaker operations,

a wide range of locking devices can be installed or retrofit, including:

- Lockable drawout version to protect against unauthorized removal (standard)
- High degree of protection through Plexiglas cover
- Mechanical reclosing lockout after long-time, short-time or instantaneous trip (optional)
- Devices with trip unit ETU745 or higher are equipped with temperature sensors on the BSS and COM15/COM16 (standard)
- Lock provision for locking the breaker in the OPEN position
- Lockable covers for the CLOSE button
- Lockable racking handle prevents moving the breaker
- Lockable charging handle prevents charging the springs

Standard Version Features

WL Circuit Breakers have the following standard equipment:

- Mechanical CLOSE and mechanical OPEN push buttons
- Manual operating mechanism with mechanical closing
- Contact position indicator
- Front panel ready-to-close indicator

- Spring charge indicator
- Rear vertical main contacts
- Main contact replacement flag
- Auxiliary plug system with bare wire pressure screw terminals. Delivery includes all auxiliary plugs necessary for both factory installed and future field installed accessories
- Mechanical trip indicator of the overcurrent release system
- Automatic reset after trip
- The front panel cannot be removed if the circuit breaker closed
- Laminated main contact fingers as part of the breaker contact strip on the drawout circuit breaker
- Breaker position display in the operator's panel
- Captive crank handle for racking out the breaker
- Guide frame with guide rails for easy handling of draw-out version
- Breaker cannot be moved in the CLOSED state
- Rated current coding between the guide frame and the breaker
- Suitable for reverse feed applications
- The breaker is always equipped with the required number of secondary disconnect blocks

Exclusive Features

Generator/Utility Protection Sets

24/7/365 power availability is critical for some systems. On-site generation capability is growing more and more common in many systems. All of the WL digital electronic trip units allow the system designer to precisely tailor trip settings for the most demanding requirements. However, the 776 trip unit allows one set of trip settings for a fully loaded utility feed and with a simple contact closure, the trip unit toggles to a second trip set tailored to provide optimal generator protection. The wide range of settings allows the WL to provide protection for a minimal generator capacity for only essential loads, through full backup for an entire facility. This dual utility/generator protection capability in a single circuit breaker allows the system designer unparalleled, cost effective, flexibility.

Dynamic Arc-Flash Sentry

A unique feature of the WL trip unit allows the system designer to achieve lower levels of arc flash energy and delayed tripping for selective trip coordination purposes.

Dynamic Arc-Flash Sentry (DAS) employs the unique dual protective setting capability of the 776 trip unit, coupled with the ability to easily toggle to a lower arc flash parameter set. A normal operation parameter set can be optimized for selective trip coordination, while the second set is optimized for lower arc flash energy levels. The dynamic action comes from the ability to switch from the normal operation set to the arc flash limiting set based on the presence of personnel as they approach the flash protection boundary. A wide variety of switching methods may be used based on the needs of a particular facility. The capabilities range from fully automatic switching using appropriate occupancy sensors to manual switching via a key operation.

Extended Instantaneous Protection

Extended Instantaneous protection (EIP), another unique feature of the WL trip unit, allows the system designer to achieve full selective trip coordination up to the short-time rating of the frame while also allowing application of the breaker up to the interrupting rating of the frame. The typical power circuit breaker with an 'LS' trip unit, or when

the instantaneous function is switched off on an 'LSI' trip unit, can only be applied up to its short-time rating, commonly 85kA or less. For application on systems with levels of available fault current above the short-time rating, the typical 'LS' power circuit breaker cannot be applied or must employ an instantaneous override. This instantaneous override is set at as much as 20% below the short-time rating and can seriously compromise selective trip coordination with downstream breakers.

The WL, equipped with EIP, overcomes these limitations by providing full withstand capability, and full coordination, with a minus 0% short-time band tolerance up to 85kA on frame Size II and 100kA on Size III. Above fault currents of 20% higher than the full short-time rating, the WL breaker is self-protecting, and the EIP function will trip the breaker instantly to protect the frame and the system from these extremely high currents, as high as 150kA on frame Size III. One added benefit is that arc flash energy is greatly reduced in this high current region due to the instantaneous trip response that EIP provides.

Lug Information

For Use With Type(s)	Circuit Breaker Ampere Rating	Cables Per Lug	Lug Wire Range	Catalog Number
BQ, BQH, BQHF, BQE, BQF, BL, BLH, HBL, HBQ, Switching Neutrals, BG, BLG	Line Side			
	15-40	1 1	#14-#6 AWG Cu #12-#6 AWG Al	TC1Q1 ^{①②}
	45-125	1 1	#8-#1 AWG Cu #6-#1/0 AWG Al	TA1Q1 ^②
	Load Side			
	15-20	1 1	#14-#10 AWG Cu #12-#10 AWG Al	Lugs are integral to Circuit Breaker
	25-35	1 1	#14-#6 AWG Cu #12-#6 AWG Al	Lugs are integral to Circuit Breaker
	40-50	1 1	#8-#6 AWG Cu #8-#4 AWG Al	Lugs are integral to Circuit Breaker
	55-70 *exceptions in Table A	1 1	#8-#4 AWG Cu #8-#2 AWG Al	Lugs are integral to Circuit Breaker
	80-100	1 1	#4-#1/0 AWG Cu #2-#1/0 AWG Al	Lugs are integral to Circuit Breaker
	110-125	1 1	#2-#1/0 AWG Cu #1/0-#2/0 AWG Al	Lugs are integral to Circuit Breaker
BQD, CQD, BQD6, CQD6	Line Side (CQD, CQD6) & Load Side			
	15-40	1	#14-#6 AWG Cu #12-#6 AWG Al	Integral
	45-100	1	#8-#1 AWG Cu #6-#1/0 AWG Al	Integral
NGG, HGG, LGG	15-30	1	#14-#6 AWG Cu #12-#6 AWG Al	TC1Q1
	15-30	1	#14-#6 AWG Cu #12-#6 AWG Al	3TC1Q1 (pkg. of 3)
	35-125	1	#8-#1/0 AWG Cu #8-#2/0 AWG Al	3TC1GG20 (pkg. of 3)
	15-125	—	NUT KEEPER PLATE	TNKG3 ^③ (pkg. of 3)
NEG, HEG	15-125	1	#14-3/0 AWG Cu	3TW1EG30 (pkg. of 3)
	15-125	1	#14-1/0 AWG Cu/Al	3TA1EG10 (pkg. of 3)
	15-125	1	#6-3/0 AWG Cu/Al	3TA1EG30 (pkg. of 3)
	15-125	—	Nut Keeper Kit (3-pole)	TNKE3 (pkg. of 3)
	15-125	—	Nut Keeper Kit (4-pole)	TNKE4 (pkg. of 4)

Connector wire ranges and cavities are established in conjunction with Table 6.1.4.2.1 of UL 489 standards.

Table A

For Use With Type(s)	Circuit Breaker Ampere Rating	Cables Per Lug	Lug Wire Range	Number of Poles
Load Side				
BQ, BL, QP	55-60	1	#8-#4 AWG Cu-Al #3 AWG requires 22 or 65 kAIC	This exception is applicable to 1- and 2-pole only

Note:

(A) Molded case circuit breakers having a rated ampacity of 125 amperes or less are to be connected with 60 or 75°C wire. Circuit breakers having a rated ampacity greater than 125 amperes shall only be cabled with 75°C cable unless otherwise indicated on the circuit breaker label. Exceptions to this rule are outlined in article 110-14 C(1)(2) of the 2005 National Electrical Code.

(B) Connector wire ranges and cavities are established in conjunction with Table 6.1.4.2.1 of UL 489 standards.

- ① Lug is steel.
- ② Sold in package of six.
- ③ One nut keeper plate is required with each lug on the NGG breaker.

Lug Information

Aluminum Body Lugs for Copper or Aluminum Wire

Selection

For Use With Type(s)	Circuit Breaker Ampere Rating	Cables Per Lug	Lug Wire Range	Catalog Number
QR2, QR2H, HQR2, HQR2H	100-250	1	#3-300 Kcmil Al/C	3TA1QR300 (3 lugs per kit)
All 2, 3-pole ED2, ED4, ED6, ED6 ETI, HED4, HHED6	15-25	1	#14-#10 AWG (Cu) #12-#10 AWG (Al)	SA1E025
	30-100	1	#10-#1/0 (Cu or Al)	LN1E100
	110-125	1	#3-3/0 (Cu) #1-2/0 (Al)	TA1E6125
CED6 All 1-pole ED, HED	30-60	1	#10-4 (Cu or Al)	LD1E060 (Load Side)
	70-100	1	#4-#1/0 (Cu or Al)	LD1E100 (Load Side)
FXD6-A, FD6-A, HFD6, CFD6 HHFD6	70-250	1	#6 AWG-350 kcmil (Cu) #4 AWG-350 kcmil (Al)	TA1FD350A
SJD6-B, SHJD6-B SCJD6-B	65-200	1-2	#4 AWG-3/0 (Cu or Al)	TA2J630
JXD2(A), JXD6(A), JD6(A), SJD6-B, HJD6(A), HJXD6(A) HHJXD6, HHJD6, SHJD6-B, CJD6, SCJD6-B	200-400	1-2	3/0-500 kcmil (Cu) 4/0-500 kcmil (Al)	TA2J6500
LXD6(A), LD6(A), SLD6-B, HLD6(A), HLXD6(A), HHLXD6, HHL6, SHLD6-B, CLD6, SCLD6-B	250-600	1-2	3/0-500 kcmil (Cu) 4/0-500 kcmil (Al)	TA2J6500
LMD6 ^① , LMXD6 ^① , HLM6 ^① , HLMXD6 ^① , MD6, MXD6, SMD6-B, HMD6, HMXD6, SHMD6-B, CMD6, SCMD6-B	500-600	1-2	#1-500 kcmil (Cu or Al)	TA2K500
		1-3	1/0-500 kcmil (Cu or Al)	TA3K500
	500-800	1-2	500-750 kcmil (Cu or Al)	TA2N750^②
ND6, NXD6, SND6-B, HND6, HNXD6, SHND6-B, CND6, SCND6-B	800-1200	1-4	250-500 kcmil (Cu or Al)	2TA4P8500^{②③} 3TA4P8500^{②④}
			250-500 kcmil (Cu or Al)	2TA4N8500^③ 3TA4N8500^④
PD6, HPD6, CPD6 PXD6, HPXD6, SPD6-B, SHPD6-B	1200-1600	1-5	300-600 kcmil (Cu or Al)	TA5P600
PD6, PXD6, HPD6, HPXD6, SPD6-B, SHPD6-B, RD6, RXD6, HRD6, HRXD6, STD	1200-2000	1-6	300-600 kcmil (Cu or Al)	TA6R600

① Use TA2K500 or TA3K500 only.
 ② Used for 100% rated MD/ND frame breakers.
 Rated for 90° C cable.

③ Contains 2 connectors plus 1 NDTs end barrier.
 ④ Contains 3 connectors plus 1 NDTs end barrier.

Lug information

Optional Mechanical Lugs

Selection

For Use With Type	Circuit Breaker Ampere Rating	Cables Per Lug	Lug Material	Lug Wire Range	Qty Per Catalog No	Catalog Number
QR2, QR2H, HQR2, HQR2H	100-250	1	Cu	#3 - 300 Kcmil Cu ONLY)	3	3TC1QR2520 (3 lugs per kit)
ED, HED 1, 2 & 3-pole	1, 2 & 3-pole 30-125	1	Cu	#10-#1/0 (Cu)	1	TC1ED6150
HFD6, HHFD6, CFD6, F(X)D6-A	70-250	1	Cu	#6 AWG-350 kcmil (Cu)	1	TC1FD350
J(X)D2(A), J(X)D6(A), HJD6(A), HHJD6, SHJD6-B, L(X)D6(A), HHL6, SCD6-B, HLD6(A), SHLD6-B, CJD6, CLD6, SCJD6-B, SCLD6-B	200-600	1 1-2	Cu	3/0-600 kcmil (Cu) 3/0-500 kcmil (Cu)	1 1	TC1J6600 ^① TC2J6500 ^①
	250-600	1 1	Al	500-750 kcmil (Al) 500-600 kcmil (Cu)	1	TA1L6750
SMD6-B, M(X)D6, HM(X)D6, HMD6,	500-600	1-2	Cu	#1 AWG-500 kcmil (Cu)	1	TC2K500
		1-3	Cu	#1 AWG-350 kcmil (Cu)	1	TC3K350
CMD6, SCMD6-B, SND6-B, N(X)D6, HN(X)D6,	700-800	1-2	Al	500-750 kcmil (Cu) 500-750 kcmil (Al)	2	2TA2N8750
					3	3TA2N8750
SHND6-B, CND6, SCND6-B	800-1200	1-3	Al	500-750 kcmil (Cu) 500-750 kcmil (Al)	2	2TA3N8750
					3	3TA3N8750
R(X)D6, HR(X)D6	1600-2000	1-5	Cu	300-600 kcmil (Cu)	1	TC5R600
P(X)D6, HP(X)D6, CPD6, SPD6-B, SHPD6-B	1200-1600	1-4	Al	600-750 kcmil (Cu/Al)	1	TA4P750▲

Compression Lugs

For Circuit Breaker Types	Ampere Rating	Poles	Lugs Per Kit	Lug Wire Size	Catalog Number
Lugs (contains indicated number of lugs and necessary hardware per kit)					
ED2, ED4, ED6, HED4, HHED6, CED6	15-125	1, 2, 3	1	#2/0 AWG Cu/Al	CCE125
QR2, QR2H, HQR2, HQR2H	100-250	2-3	1	#6 - 350kcmil Al/Cu	CCQ250
F(X)D6-A, HF(X)D6, HHF(X)D6, CFD6	125-250	2, 3	1	350 kcmil	CCF250
JXD2-A, J(X)D6-A, HJ(X)D6-A, HHJ(X)D6-A, CJD6, SJD6-B, SHJD6-B, SCJD6-B, L(X)D6-A, HL(X)D6-A, CLD6, SLD6-B, SHLD6-B, SCLD6-B	200-600	2, 3	1	500 kcmil	CCL600
Kits (contain lugs and hardware for complete line or load end of 2 or 3-pole breaker)					
M(X)D6, HM(X)D6, CMD6, SMD6-B, SHMD6-B, SCMD6-B	500-800		2	500 kcmil	CCM800K2
			3		CCM800K3
N(X)D6, HN(X)D6, CND6, SND6-B, SHND6-B, SCND6-B	900-1200		2	500 kcmil	CCN1200K2
			3		CCN1200K3

Distribution Lugs^②

For Circuit Breaker Types	Ampere Rating	Poles	Lugs Per kit	Wires Per Lug	Lug Wire Size	Catalog Number
NGG, HGG, LGG	15-125	1,2,3	1	6	#6-#4 AL #14-#4 Cu	TA6GG04
NEG, HEG	15-125	1,2,3	3	3	#14-#2 AWG Cu	3TA3EG02
NEG, HEG	15-125	1,2,3	3	6	#14-#6 AWG Cu	3TA6EG06
ED2, ED4, ED6, HED4, HHED6, CED6	15-125	1,2,3	1	6	#14-#4 AWG Cu #6-#4 AWG Al	TA6ED06
F(X)D6-A, HF(X)D6, HHF(X)D6, CFD6	70-250	2,3	1	6	#14-#4 AWG Cu #6-#4 AWG Al	TA6FD04
JXD2-A, J(X)D6-A, HJ(X)D6-A, HHJ(X)D6-A, CJD6-A, SJD6-B, SHJD6-B, SCJD6-B, L(X)D6-A, HL(X)D6-A, CLD6-A, SLD6-B, SHLD6-B, SCLD6-B	200-600	2,3	1	6	#14-2/0 AWG Cu #6-2/0 AWG Al	TA6JD20

▲ Built to order. Allow 6-8 weeks for delivery.

① Used for 100% rated JD/LD frame circuit breakers.

② Special purpose wire connectors, not for general use.

Molded Case Circuit Breakers

A variety of internal and external accessories, as well as modifications, are available to adapt Siemens circuit breakers to special installation requirements. UL listed internal accessories for 100 through 2000A circuit breakers are field-addable.

Internal accessories fine tune an electrical distribution system, allowing control of the circuit breakers to meet special application requirements. For example, emergency situations may dictate tripping critically placed circuit breakers quickly. Shunt trips accomplish this conveniently and efficiently. Or, when voltage drops are a concern, undervoltage trips automatically open the circuit breaker at a predetermined voltage level.

A wide range of external operating and mounting accessories is also available. For example, face, shallow, and back mounting plates are ideal for tailoring BQ circuit breakers to OEM applications. A complete line of operating handles and handle-blocking devices meet switchboard, enclosure and safety needs. Plug-in mounting assemblies, which simplify switchboard mounting of circuit breakers and permit breaker removal without disconnecting bus or cable connections, are available.

50°C Ambient Calibration — Not UL listed and not available for solid state, 100% rated breakers or 400HZ calibrated breakers.	
For BL Type Circuit Breakers — Add suffix 'M' to catalog number (Example: B120M).....	No Charge
For BQ and ED Frame Circuit Breakers — Replace 'B' in catalog number with 'M' (Example: BQ3M060, ED63M060)	No Charge
For FD, JD, LD, LMD, MD, ND, PD, and RD Frame Circuit Breakers Non-Interchangeable Trip (3-pole only) — Replace 'B' in catalog number with 'M' (Example: FXD63M225, JXD63M400)	No Charge
400 HZ Calibration	
UL Listed (5KA IR)	
For BQ & BL Type Circuit Breakers (200A max.).....	Add 25% to list price
— Add suffix 'Y' to catalog number	
Not UL Listed	
For all other Circuit Breakers, see derating tables on page 7-101 and order standard circuit breakers.	
Fungus Proofing	
All BQD, CQD, GB, GG, ED, FD, JD, LD, LMD, MD, ND, PD, RD, DG, FG, JG, LG, MG, NG, and PG Frame Circuit Breakers are inherently fungus resistant and do not require special treatment.	
For BL, and BQ Type Circuit Breakers.....	Add \$10.00 net per pole
— Consult Sales Office for Availability	
For all other Circuit Breaker Types.....	Add \$160.00 net per device
— Consult Sales Office for Availability	
Certificate of Compliance with Test Report (catalog number CERT OF COMP.) Add \$210.00 net	
Certificate of compliance testing must be performed on the actual device being shipped. The certificate cannot be provided after initial shipment. Order for devices with COC requirement must be placed directly with the factory by the sales office and shipped directly to the end user.	

UL 489 Supplement SB Naval Use Breakers

Breakers tested to UL 489 Supplement SB are qualified for use on non combat and auxiliary naval vessels.

Siemens molded case breakers, including BL, NGB and Sentron ED through RD frames can be labeled "NAVAL" in compliance with UL 489 Supplement SB.

Supplement SB testing comprises two sets of vibration tests. The first is to find mechanical resonances in the product and to subject the breaker to extreme testing at each resonant frequency. The second is a swept frequency test, in which the frequency of excitation is changed in intervals of 1Hz, and held at each frequency for five minutes. The excitation frequencies run from 4 to 33Hz, and the test is conducted in each of the three orthogonal axes of the breaker.

During these tests, the breaker must not trip from the closed position, nor may the contacts touch from the open position. Calibration and insulation resistance are also verified during the test.

For detailed information, refer to UL 489, Supplement SB.

Ordering Information

For "NAVAL" label, add **\$75.** net per catalog number per order. Order must be placed directly with the factory by Siemens Sales Office.

Types	UL File
BQD/CQD	E10848, Vol 10, Sec 1
GG	E10848, Vol 10, Sec 2
GB	E10848, Vol 10, Sec 3
ED2, ED4, IIED4, HED6	E10848, Vol 4, Sec 11
CED6	E10848, Vol 4, Sec 13
FD6, FXD6, HFD6, HFXD6	E10848, Vol 4, Sec 17
CFD6	E10848, Vol 4, Sec 18
JXD2, JD6, JXD6, LXD6, LD6, HJD6, HJXD6, HLD6, HLXD6	E10848, Vol 4, Sec 8
HHJD6, HHJXD6, HHLD6, HHLXD6	E10848, Vol 4, Sec 20
CJD6, CLD6	E10848, Vol 4, Sec 14
MD6, MXD6, HMD6, HMXD6, CMD6, ND6, NXD6, HND6, HNXD6, CND6	E10848, Vol 4, Sec 15
PD6, PXD6, HPD6, HPXD6, CPD6, RD6, RXD6, HRD6, HRXD6	E10848, Vol 4, Sec 19

Molded Case Circuit Breakers

Internal Accessories

General

Feature Combinations

The available feature combinations are shown in the chart below. For applications requiring combinations of features not listed in this chart, consult the sales office for availability.

Breakers	Modules Per Breaker	Avail. On Breaker Poles	ST	ST/AUX	ST/ALSW	ST/AUX/ALSW	UVT	UVT/AUX	UVT/ALSW	UVT/AUX/ALSW	AUX	AUX/ALSW	ALSW	Elect. Bell Alarm	Ground fault	Grd fault w/Bell
QP, BQ, BL ^①	1	1, 2, 3	1	—	—	—	—	—	—	—	1,2	—	—	—	—	—
BQD, CQD, GB, GG	1	2, 3	1	1/1	—	—	—	—	—	—	1,2	1/1	1	—	—	—
QR	1, 2	2, 3	1	1/1	—	—	—	—	—	—	2	—	—	—	—	—
All ED	1	1, 2, 3	1	1/1,1/2	1/1	1/1/1	1	1/1, 1/2	1/1	1/1/1	1, 2	1/1, 2/1	1	—	1	1
All FD	2	2, 3	1	—	—	—	1	1/1	—	—	1, 2	1/1	1	—	—	—
All JD, LD, LMD ^②	2	2, 3	1	1	—	—	1	1/1, 1/2	—	—	1, 2	1/1, 1/2	1, 2	—	—	—
SJD, SHJD, SCJD,SLD, SHLD, SCLD ^③	1	3	1	1	—	—	1	1/1, 1/2	—	—	1, 2	1/1, 1/2	1, 2	—	—	—
All MD, ND, PD, RD Including Electronic trip ^④	2	2, 3	1	1/1	—	—	1	1/1, 1/2	—	—	1, 2	1/1, 2/1	1, 2	—	—	—
STD ^⑤	6	3	1	—	—	—	1	—	—	—	1 NC / 1 NO, 2 NC / 2 NO, 3 NC / 3 NO, 4 NC / 4 NO, 5 NC / 5 NO, 6 NC / 6 NO	—	1	1	—	—

Shunt Trip (ST)

One or all critical circuit breakers may be tripped from a distant control point by use of a shunt trip device. A shunt trip operates through an auxiliary switch contact; when the breaker opens, current is not maintained on the shunt trip coil.

Undervoltage Trip (UVT)

When voltage drops to a value below 35% of the nominal coil rating, the undervoltage trip device automatically opens the breaker. The operation is instantaneous, and the circuit breaker cannot be reclosed until the

voltage returns to 85% of line voltage. The undervoltage trip, which is continuously energized, must be energized before the circuit breaker can be closed.

Auxiliary Switch (AUX)

For applications requiring remote "on" or "off" indication (or electrical interlocking), auxiliary switches are available. Each switch comprises an "A" (open when circuit breaker is open) and a "B" (closed when circuit breaker is open) contact with a common connection. (Form C)

Alarm Switch (ALSW)

The alarm switch contact is closed when the circuit breaker is opened automatically by an overload, short circuit, shunt trip or undervoltage trip. The alarm switch contact is open when the circuit breaker is reset.



For ED Frames



For FD Frames



For JD and LD Frames

①Factory assembled only

②If mechanical interlock is installed, no accessory module can be installed in the right pocket.

③If mechanical interlock is installed, no accessory module can be installed.

④If mechanical interlock is installed, no accessory module can be installed in the left pocket.

⑤One module per column.

Circuit Breakers

Circuit Breaker Accessories

Circuit Breaker Accessories ④⑤⑥⑦⑧⑨

Catalog Number	For Use With Breaker Type	Number of Poles	Standard Package
Padlocking Device For locking breaker in "OFF" position. Note "ON" position does not affect breaker functionally			
ECPLD1	Type QP, BL, QAF2, QPF2, QE, QT-Duplex, BQ, BQXD	1P	3 Pieces
ECPLD1R	Type QP, BL, QAF2, QPF, QE, QT-Duplex, BQ, BQXD (Red Color)	1P	3 Pieces
ECPLD2	Type QP, BL, QAF2, QPF, QE, QT-Triplex & Quadplex, BQ, BQXD	2P	3 Pieces
ECPLD2R	Type QP, BL, QAF2, QPF, QE, QT-Triplex & Quadplex, BQ, BQXD (Red Color)	2P	3 Pieces
ECPLD3	Type QP, BL, QAF2, QPF, QE, BQ	3P	1 Piece
US2:ECPLD3R	Type QP, BL, QAF2, QPF, QE, BQ (Red Color)	3P	1 Piece
ECQLD3	Type QP, BL, BQ, BQXD	1P	10 Pieces
ECQLD4	Type QT-Duplex	QT-Duplex Breakers	10 Pieces
ECQLN3 ^②	150-225 MBKA, QN, QNR	n/a	1 Piece
ECQTH4	Type QP, BL, BQH	Designed for (3) 1P Breakers	1 Piece
Handle Tie Provide simultaneous swiveling of 2 adjacent handles.			
ECQTH2	Type QT Duplex	Designed for (2) QT Duplex Breakers	25 Pieces
ECQTH3	Type QP, BL	2P	50 Pieces
Mechanical Interlock^①			
ECQML12	Type QP, BL, BQ Interlock Bracket	Designed for 1" Breaker	10 Pieces
Handle Blocking Device For holding breaker in "ON" or "OFF" position. Not a lockout/tagout device			
ECQTH2	Type QP, BL, BQ, BQXD	1P	10 Pieces
ECQTH3	Type QT-Duplex	1/2" Breakers	10 Pieces
Main Breaker Retainer			
ECMBR1 ^③	EQ Load Centers		1 Piece
ECMBR2	Ultimate Load Centers		1 Piece
Mounting Accessories			
MB120	Type BQ, BQH Mounting Clips	1P	20 Pieces
FP9508	Type BQ, BQH FACE MOUNT PLATE	1P	10 Pieces
FP9555	Type BQ, BQH FACE MOUNT PLATE	2P	10 Pieces
FP9556	Type BQ, BQH FACE MOUNT PLATE	3P	10 Pieces
SMB6R	Type BQ MOUNTING BRACKET	1P, 2P, 3P	6 Pieces
TCH65K	Type BQ MOUNTING ADAPTER		500 Pieces
BR2	Type BQ, BQH, BQXD Back Mounting Plates	2P	10 Pieces
BR3	Type BQ, BQH, BQXD Back Mounting Plates	3P	10 Pieces
BR4	Type BQ, BQH, BQXD Back Mounting Plates	4P	10 Pieces
I0204ML1125CU	Type QP Back Mounting Plates	1P, 2P	10 Pieces
I0303ML3100CU	Type QP Back Mounting Plates	3P	10 Pieces
Replacement Lugs			
TA1Q1	Type BQ, NGG 100A AI Cu LGS	n/a	6 Pieces
TC1Q1	Type BQ, NGG 40A AI Cu LUGS	n/a	6 Pieces
Finger Shield			
BQFS1K	Type BQXD Finger Shield (Bulk Pack)	n/a	1000 Pieces
BQFS2	Type BQXD Finger Shield	n/a	2 Pieces
Filler Plate			
ECQF3	1" Filler Plate	n/a	5 Pieces

① For a complete list of standby power mechanical interlock kits, see page 1-25

② For use with Ultimate Load Center Main Breakers

③ Not suitable for use on 15-50A, 10 AIC Type QP Circuit Breakers

④ QP Type includes QPH, HQP

⑤ BL Type includes BLH, HBL

⑥ BQ Type includes BQH, HBO

⑦ QAF2 Type includes QAFH2, BAF2, BAFH2, QFGA2, QFGAH2, BFGA2, BFGAH2

⑧ QPF Type includes QPHF, BLF, BLHF

⑨ QE Type includes QEH, BLE, BLEH

Padlocking Device



ECPLD1

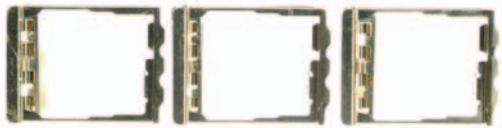

ECPLD2



ECPLD1R/2R/3R (Single pole pictured. 2-/3-pole available)



ECQLD3

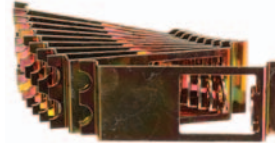

ECQLD4

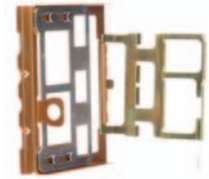

ECQTH4

Handle Tie



ECQTH2



ECQTH3

Handle Blocking Device

ECQL1



ECBX231M



Main Breaker Retainer



ECMBR1



ECMBR2

Mechanical Interlock

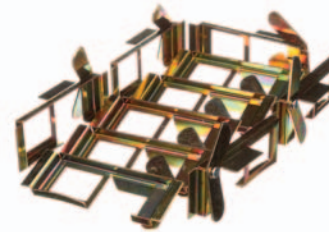

ECQML12

Mounting Accessories



MB120



SMB6R



I0204ML1125



FP9508

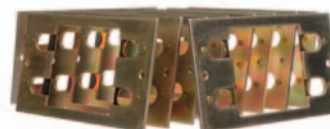

FP9555



FP9556

Molded Case Circuit Breakers

External Accessories

Selection

Handle Ties with Padlock Device

Provide simultaneous switching of 2 or 3 adjacent handles.
Do not provide common trip.

For Use With Breaker Frame(s)	Catalog Number	Standard Package	Wt Lb/Std Pkg
BQD, NGB, HGB, LGB	BQDHT2	10	½
	BQDHT3	10	½

Padlocking Devices

For locking breaker in "OFF" position.

All QR	HPLQR	1	¼
All BQD, CQD, NGB, HGB, LGB	BQDPLD	1	⅝
NGG, HGG, LGG	HPLG	1	¼
EB, 1- thru 3-pole	HPLEB	1	⅝
EG, 3- and 4-pole only	HPLE	1	¼
All ED	ED2HPL	1	¼
All FD	FD6PL1	1	¼
All JD, LD, LMD	JD6HPL	1	¼
All MD, ND, PD, RD	MN6PLD	1	¼



FD Padlocking Device
FD6PL1

Handle Blocking Devices

For holding breaker in "ON" or "OFF" position.
Not a lockout/tagout device.

All QR	HBLQR	1	1
All BQD, CQD, GG, GB	BQDHBD	1	¼
EG	HBDE	1	¼
All ED	E2HBL	1	¼
All FD	FD6HB1	1	½
All JD, LD, LMD	JD6HBL	1	½
All MD, ND, PD, RD	MN6BL	1	½



FD Handle Blocking Device
FD6HB1

Handle Extensions

For replacement. One extension shipped with breaker.

All MD, ND, PD, RD	EX11	1	2
--------------------	-------------	---	---



Handle Extension
EX11

Terminal Shields

Breaker Type	Poles	Catalog Number	Standard Package
NGG	3	TSSG3A	1
	1	TSSG61	1
HGG, LGG	2	TSSG62	1
	3	TSSG63	1

■ Built to order. Allow 2-3 weeks for delivery.

Ⓞ Sold only in standard package quantities.

Molded Case Circuit Breakers

Face Mounting Plates

For Use With Breaker Frame(s)	Number of Poles	Catalog Number	Standard Package	Wt Lb/Std Pkg
CQD, CQD6	1	CQDFMB1	1	¼
	2	CQDFMB2■	1	¼
	3	CQDFMB3■	1	¼
NGG, HGG, LGG	1	FMPG1	1	¼
	2	FMPG2	1	¼
	3	FMPG3	1	¼

Back Mounting Plates

ED2, ED4, ED6, HED4, HED6	1	E2BMB	1	¼
---------------------------	---	-------	---	---

Mounting Screw Kits

CQD, CQD6	CQDSMK ^①	1	1¼
NGG, HGG, LGG	MSKG4 ^②	1	¼
All QR	MSQR3	1	½
All ED (CED6 requires 2 kits)	MSE6 ^③	1	¼
	MSE6100 ^④	100 ^④	1
All FD (CFD6 requires 2 kits)	MSF6 ^③	1	¼
	MSF650 ^④	50 ^④	1
All EG 1-pole	MSKE1	—	—
All EG 2-pole	MSKE2	—	—
All EG 3 or 4-pole	MSKE4	—	—
All JD, LD	MSJ6 ^⑤	1	¼
All LMD	MSLMD	1	¼
All MD, ND,	MSMN	1	¼
All PD, RD	MSPR6	1	2

"MI" Mechanical Interlocks

For Use With Breaker Type(s)	Panel ^⑦ Mounted	Plug-in Mounted	Standard Package	Wt Lb Std Pkg
All EG (Sliding Bar)	HSBE	—	1	—
All QR (Sliding Bar)	SBMIQR	—	1	1½
All FD	MI5444	MI5444	1	—
All JD, LD	MI5413 ^④	—	1	1
All LMD	MI5406 ^④ ■	—	1	1
All MD	MI5404 ^⑤ ■	—	1	3
All ND	MI5404 ^⑤ ■	—	1	3
All PD, RD	MI5405 ^⑤ ▲	—	—	—

- Built to order. Allow 2–3 weeks for delivery.
- ▲ Built to order. Allow 6–8 weeks for delivery.
- ① Kit consists of 4 screws and washers.
- ② Consists of 1 screw and washers (order 100).
- ③ Consists of 1 screw and washers (order 50).

- ④ With mechanical interlock in place, no accessory can be installed into circuit breaker right pole.
- ⑤ Addition of the mechanical interlock will prevent accessory installation in the left pole.
- ⑥ Sold only in standard package quantities. Multiply List Price Each times package quantity for full price.

- ⑦ Mechanical interlock is not designed for use within Siemens panelboards.



Molded Case Circuit Breakers

External Accessories

Selection

Rotary Door Mounted Operating Handles

Types 1, 3, 3R, 12, 4 4X

For Use With Breaker Frames	Complete Mechanism		Handle Only	Breaker Operator	Shaft Only	
	Catalog Number				Catalog Number	Length (inches)
	Standard Depth	Variable Depth				
EG	RHVE64X	RHVE124X	—	—	—	—
ED ^①	CRHOESD	CRHOEVD	CRHOH ^③	RHOEBO	2	RHOSSD
FD	CRHOFSD	CRHOFVD		RHOFBO	12	RHOSVD
JD, LD	CRHOJSD	CRHOJVD		RHOJBO	16	RHOSXD
LMD	CRHOLMSD	CRHOLMVD		RHOLMBO		
MD, ND PD, RD	RHONSD	RHONVD	RHOH ^③	RHONBO ^④	3 12 24	RHONSSD▲ RHONSVD RHONSXD

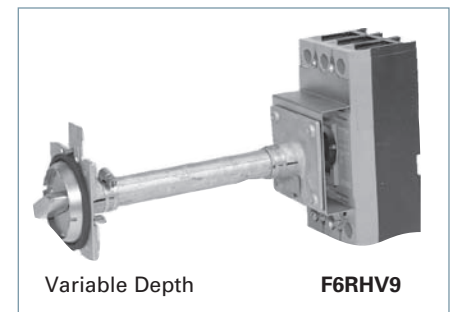

Rotary Door Mounted Operating Handles

Types 1 & 12

For Use With Breaker Frames	Standard Depth Catalog Number	Variable Depth Catalog Number	Handle and Shaft Catalog Number	Breaker Operator Catalog Number
CQD, NGG, HGG, LGG	—	RHOCQVD	RHOH62 ^⑤	CQDOP
ED	D11CEU1	D11CEU2	—	—
FD	D11CFU1▲	D11CFU2	—	—
JD, LD	—	D11CJU2	—	—

For CQD, NGG, HGG and LGG red emergency handle, order assembly RHOCQVDE (includes handle and operator).▲
For CQD, NGG, HGG and LGG in a NEMA 3R enclosure, order CQDOP34 operator, RHOH handle and RHOSVD shaft.
For CQD, NGG, HGG and LGG in a NEMA 4 or 4X enclosure, order CQDOP34 operator, RHOH4 handle and RHOSVD shaft.

Through Door Mounted Operating Handles^②

Types 1 & 12

For Use With Breaker Frames	Standard Depth	Variable Depth
	Catalog Number	Catalog Number
CQD, NGG, HGG, LGG	FMHOS	—
EG (3 & 4-Pole only)	RHFESD	—
EG (red handle)	RHFESDEM	—
ED	E2RH1	E2RHV9
FD	F6RH1	F6RHV9

Door Latch Kits

Type	Catalog Number	
	Right Hand	Left Hand
2 point latch	DKR2	DKL2■
3 point latch	DKR3	DKL3■

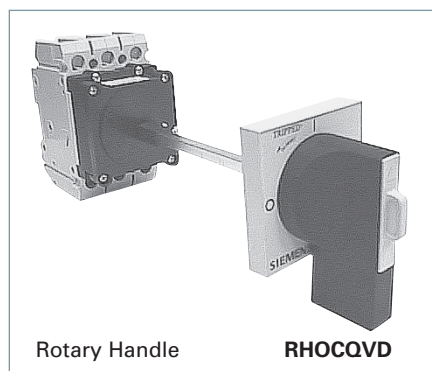

- Built to order. Allow 2-3 weeks for delivery.
- ▲ Built to order. Allow 6-8 weeks for delivery.
- ① For use on 3-pole ED frame only.

- ② Meets the requirements of NFPA 79, section 5.3.3.1 for locking external operator disconnecting devices.
- ③ For 3 or 3R, order shaft and breaker operator as shown, and handle RHOH. For 4 & 4X, order handle RHOH4. Consult sales office for additional EG operator shaft lengths.

- ④ For extended shaft support order catalog number RHONSB2.
- ⑤ Length of shaft is 300mm (11.8 inches).

Molded Case Circuit Breakers

External Accessories

Selection

Max-Flex™, Flange Mounted Variable Depth Operators^③

Frames	NEMA Type	Complete Kit Catalog Number	Handle Only Catalog Number	Breaker Operator Catalog Number	36" Cable Catalog Number
GG	1, 3 (R), 12	MFKG3R3	MFHG3R	MFMG	MFCF036
	4 (x)	MFKG4X3	MFHG4X		
EG	1, 3 (R), 12	MFKE3 ^④	—	—	—
	4 (x)	MFKE4X3	—		
ED	1, 3 (R), 12	FHOE036 ^①	FHOH	FHOEBO ^①	FHOEC036
	4 (x)	—	FHOH4		
FD	1, 3 (R), 12	FHOF036	FHOH	FHOFBO	FHOF036
	4 (x)	—	FHOH4		
JD, LD, SJD, SLD	1, 3 (R), 12	FHOJ036	FHOH	FHOJBO	FHOJC036
	4 (x)	—	FHOH4		
LMD	1, 3 (R), 12	FHOLM036	FHOH	FHOLMBO	FHOJC036
	4 (x)	—	FHOH4		
MD, ND, PD, RD, SMD, SND, SPD	1, 3 (R), 12	FHON048	FHOHN	FHONBO	FHONC048 ^②
	4 (x)	—	FHOHN4		



Max-Flex™ handles are available with solid black handles instead of the customary “red for on” flange handle. These are preferred for use in IEC markets, where red handles have specific meaning. Order components separately, appending the letter “i” to the catalog number (e.g. FHOHI).

Alternate Length Cable Only

	ED	FD	JD/LD/LMD	MD/ND/PD/RD
Inches	Catalog Number	Catalog Number	Catalog Number	Catalog Number
48	FHOEC048	FHOFC048	FHOJC048	FHONC048
60	FHOEC060	FHOFC060	FHOJC060	FHONC060
72	FHOEC072	FHOFC072	FHOJC072	FHONC072
96	FHOEC096	FHOFC096	FHOJC096	FHONC096
120	FHOEC120▲	FHOFC120	FHOJC120▲	FHONC120▲
144	FHOEC144▲	FHOFC144▲	FHOJC144▲	FHONC144▲

Handle Auxiliary Switch

For use with Max-Flex and Rotary Door operators (FHOH and RHOH). 1 NO and 1 NC contact (Form C).

For Use With	Catalog Number
ED, FD, JD, LD, LMD, ND, PD, RD, SD, Max Flex	HAS1

Fixed Depth Flange Mounting

Frames	Minimum Enclosure Depth	NEMA Type	Left Hand Mount	Right Hand Mount
			Catalog Number	Catalog Number
ED ^⑤	6.44	1, 3R, 12	FDFBEL▲	FDFBER▲
		4, 4X	FDFBEL4▲	FDFBER4▲
FD	6.44	1, 3R, 12	FDFBFL▲	FDFBFR▲
		4, 4X	FDFBFL4▲	FDFBFR4▲

Max-Flex™ handles are available with solid black handles instead of the customary “Red for On” flange handle. These are preferred for use in IEC markets, where red handles have specific meaning. Order components separately, appending the letter “i” to the catalog number (e.g. FHOHI).

④ Consult sales office for additional cable lengths for EG Flex Shaft Operators. For 3-Pole only.
⑤ 3-Pole ED only.

▲ Built to order. Allow 6–8 weeks for delivery.

① For 1- or 2-pole breaker order FHOED036 complete kit or FHOEBO breaker operator only. Use MFHM3R handle.

② 48 inch cable is standard length for M through R frame Max-Flex operators.

③ Meets requirements of NFPA 79, section 5.3.3.1 for locking external operator disconnecting devices

Molded Case Circuit Breakers

External Accessories

Selection/Dimensions

Telemand® Motor Operator

Breaker Frame	AC Voltage	Hinged to Open Down Catalog Number
ED except CED	120	MOE6120
	240	MOE6240▲

ED motor operator opens downward.

Breaker Frame	DC Voltage	Hinged to Open Right Catalog Number	AC Voltage	Hinged to Open Right Catalog Number
FD	24	MOF6024DC▲	120	MOF6120
	48	MOF6048DC▲	240	MOF6240
	125	MOF6125DC▲		
JD, LD	24	MOJ6024DC▲	120	MOJ6120
	48	MOJ6048DC▲	240	MOJ6240
	125	MOJ6125DC▲		
LMD	24	MOLMD6024DC▲	120	MOLMD6120
	48	MOLMD6048DC▲	240	MOLMD6240
	125	MOLMD6125DC▲		
MD, ND, PD, RD	—	—	120	EMOPL120MN
	—	—	240	EMOPL240MN

To order FD through RD motor operators with Left side hinges, add "L" to catalog number (e.g. MOF6120L). List prices are the same.▲



Telemand Motor Operator

FD, JD, LD, LMD, MD, ND, PD, RD Frames

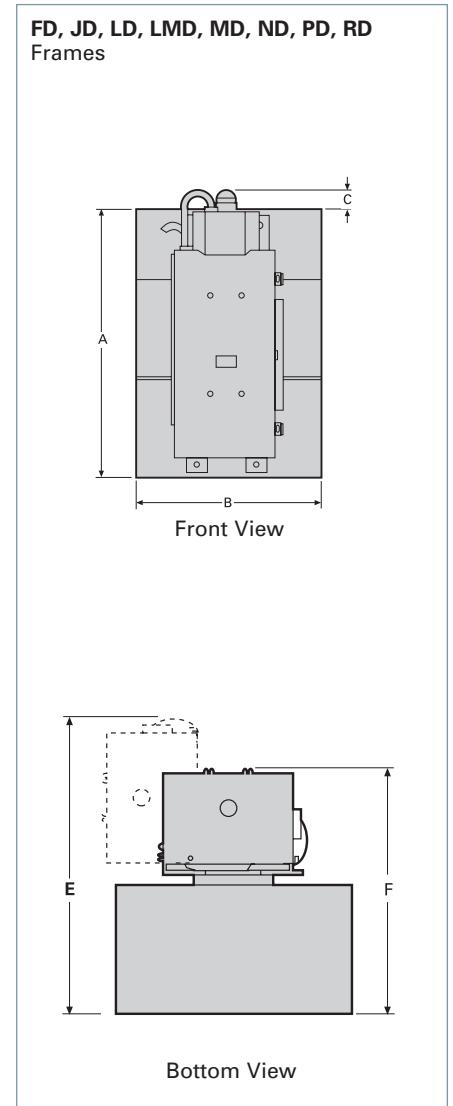

Dimensions

Frame	A	B	C	D	E	F
ED	7.04	4.31	—	4.31	13.84	8.84
FD	9.50	4.55	1.60	6.84	9.70	7.58
JD, LD, LMD	11.00	7.50	0.79	8.34	9.85	7.74
MD, ND, PD, RD	16.00	9.00	—	9.83	13.13	10.13

Operating Currents

Catalog Number	On			Off			Reset (Amps)
	In-Rush (Amps)	Running (Amps)	Time (msec)	In-Rush (Amps)	Running (Amps)	Time (msec)	
MOE6120	10.25	2.3	550	10	2.3	400	2.3
MOE6240	5.2	1.1	500	5	1	330	1.1
MOF6120/L	13.6	5.5	200	13.6	5.5	175	5.5
MOF6240/L	7.6	3.5	200	7.6	3.5	185	3.5
MOLMD6120/L	13.6	6	210	13.6	6	185	6
MOJ6120/L	13.6	6	210	13.6	6	185	6
MOJ6240/L	7.6	3.5	217	7.6	3.5	185	3.5
EMOPL120MN	15	5.5	500	15	5.5	500	5.5
EMOPL240MN	7.6	3.25	500	7.6	3.25	500	3.25

For inches / millimeters conversion, see Application Data section.

▲ Built to order. Allow 6–8 weeks for delivery.

Molded Case Circuit Breakers

Plug-In Mounting Assemblies, Including Base and Tulip Assemblies

For Use With Breaker Frames	Poles	Line Side	Load Side	Steel Switchboard Mounting Plate ^① Catalog Number
		Catalog Number ^②	Catalog Number ^②	
EG	3	PCBERC3 ^③	—	—
	4	PCBERC4 ^③	—	
All ED except CED	2	PC2637▲	PC2638▲	PL2616
	3	PC2657	PC2658	
CED	2	PC2637▲	PC2638▲	PL2617
	3	PC2657	PC2658	
All FD except CFD	2	PC4753▲	PC4753▲	PL4762
	3	PC4754	PC4754	
CFD	2	PC4753▲	PC4753▲	PL4763
	3	PC4754	PC4754	
All JD except CJD	2	PC5777▲	PC5777▲	PL5796
	3	PC5778	PC5778	
Kit CJD, SCJD	3	PCCJD	PCCJD	PL5797
All LD except CLD	2	PC5660▲	PC5660▲	PL5680
	3	PC5661	PC5661	
Kit CLD, SCLD	3	PCCLD	PCCLD	PL5797
All MD	2	PC5662▲	PC5662▲	PL9698
	3	PC5663	PC5663	
All ND	2	PC5664 ^③ ▲	PC5664 ^③ ▲	PL9699
	3	PC5666 ^③	PC5666 ^③	

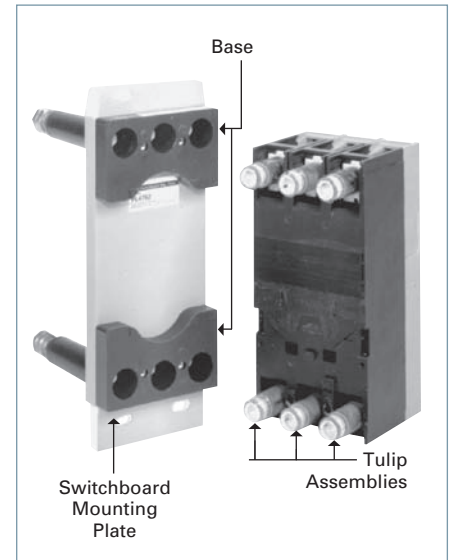

Tulip Assemblies Separately

For Frame	2-Pole	3-Pole
	Catalog Number	Catalog Number
ED	TCE2▲	TCE3▲
FD	TCF2▲	TCF3▲
JD	TCJ2▲	TCJ3▲
LD	TCL2▲	TCL3▲
MD	TCM2▲	TCM3▲
ND	TCN2▲	TCN3▲

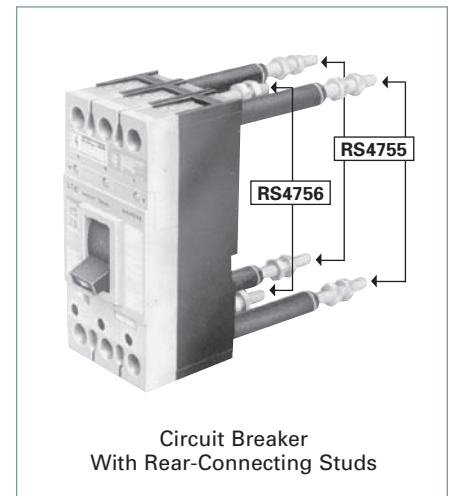

Rear-Connecting Studs

For Use With Breaker Frames	Ampere Rating	Description	Extension Behind Breaker (inches)	Line Side	Load Side
				Catalog Number ^④	Catalog Number ^④
All ED	100	Line Side (Short)	2.38	RS2643 ^⑤ ▲	—
	100	Load Side (Short)	2.38	—	RS2644 ^⑤ ▲
	100	Line Side (Long)	4.88	RS2641 ^⑤ ▲	—
	100	Load Side (Long)	4.88	—	RS2642 ^⑤ ▲
All FD	250	Short	3.12	RS4756 ^⑤ ▲	RS4756 ^⑤ ▲
	250	Long	7.06	RS4755 ^⑤ ▲	RS4755 ^⑤ ▲
All JD	400	Short	5.85	RS5774▲	RS5774▲
	400	Long	11.20	RS5773▲	RS5773▲
All LD	600	Short	5.85	RS5784▲	RS5784▲
	600	Long	11.20	RS5783▲	RS5783▲
CJD, SCJD CLD, SCLD	Add required shield kit.				CLRSJL3
LM(X)D6, HLM(X)D6	800	Short	5.85	RS5788▲	RS5788▲
		Long	11.20	RS5787▲	RS5787▲
All MD, ND	1200	Short	5.50	RS5786▲	RS5786▲
		Long	8.00	RS5785▲	RS5785▲

▲ Built to order. Allow 6–8 weeks for delivery.

①Furnished at no extra charge when ordered with plug-in mounting assembly.

②Each piece catalog number consists of (1) mounting block assembly and required tulip assemblies (2) for 2-pole, (3) for 3-pole

③For vertical bus mounting — for horizontal, substitute PC5665 for PC5664 and PC5667 for PC5666.

④Price includes one current stud, insulating tube, stud nuts and terminal shields, when required.

⑤For proper electrical clearance, studs must alternate between short and long stud lengths on circuit breaker poles (e.g. SLSLSL or LSLLSL).

⑥Plug-in assembly for EG breakers include line and load side in one assembly.

Molded Case Circuit Breakers

Unusual Operating Conditions

Reference

Note: The information provided on this and the next page is intended for reference and recommendation only. Because several variables can act on a circuit breaker's performance at the same time, the data below is based less on controlled testing, than on experience and engineering judgment. Contact Siemens for further information on special conditions and treatment.

High Ambient Temperatures

Because thermal-magnetic trip breakers are temperature sensitive and calibrated for a specific ambient of 40°C (104°F) (average enclosure temperature), a higher ambient will cause the breaker to trip at lower current than its nameplate rating, in other words, causing the breaker to "derate" (see Table 1). Similarly, the current carrying capacity of a circuit conductor is based upon a certain ambient temperature, a higher ambient will reduce its current carrying capacity, causing it to "derate." Thus, with a fluctuating temperature, a thermal-magnetic breaker will derate nearly parallel with its connected circuit conductors and maintain close circuit protection. If the application temperature exceeds 40°C (104°F) and is known, either a breaker specially calibrated for the higher ambient or one oversized according to Table 1 may be selected. In a case such as this, the circuit conductors should be oversized as well.

Siemens Sensitrip® IV and Type SB Encased Systems Breakers are insensitive to temperature changes. However, they do include circuitry to protect the components from abnormally high temperatures.

Moisture — Corrosion

For atmospheres having high moisture content and / or where fungus growth is prevalent, a special preventive treatment may be required.

Where the air is heavily laden with corrosive elements, breakers made with special corrosion-resistant finishes may be required.

Altitude

Reduced air density at altitudes greater than 6600 ft. (2000 meters) affects the ability of a molded case circuit breaker to transfer heat and interrupt faults. Therefore, circuit breakers applied at these altitudes should have interrupting, insulation and continuous currents derated as indicated in Figure 1.

Table 1 — Temperature Derating Data for Thermal-Magnetic Breakers

Reference Ampere Rating at 40°C (104°F)	Ampere Rating at:		Siemens Breaker Frames
	50°C (122°F)	60°C (140°F)	
15	13	11	BQ, BL, BQD, CQD, GG, GB, ED
20	18	16	
25	23	21	
30	28	26	
35	30	28	
40	37	34	
50	46	42	
60	56	52	
70	65	60	
90	84	78	
100	94	87	
125	114	100	
150	136	120	
175	159	140	
200	182	160	
225	205	180	
250	235	220	
300	276	252	
350	325	301	
400	372	340	
500	468	435	
600	564	525	
700	658	613	
800	754	704	
900	828	749	
1000	900	825	
1200	1090	1000	
1400	1304	1148	
1600	1500	1320	
1800	1690	1485	
2000	1880	1650	
			QR
			FD
			JD
			LD
			MD
			ND
			PD
			RD

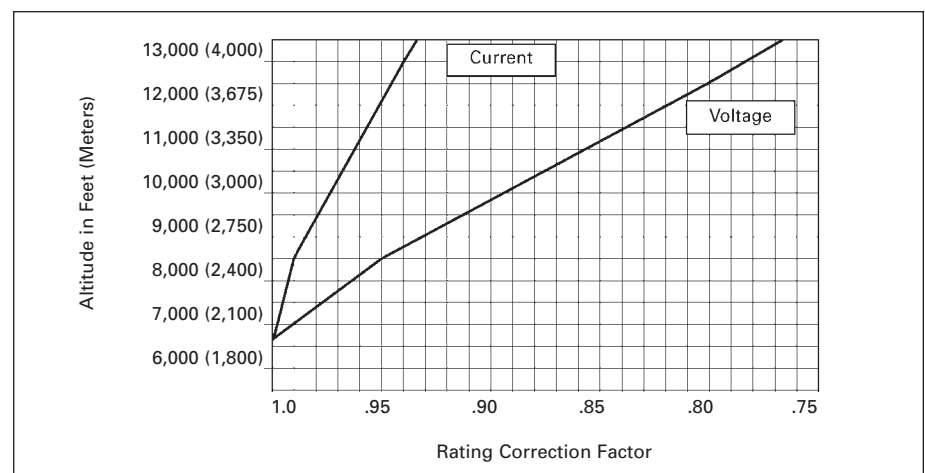

Figure 1 — Altitude Adjustment

Molded Case Circuit Breakers

400 Hz Systems^①

Siemens molded case circuit breakers can be applied for overcurrent protection on 400Hz systems, commonly used to power computer installations, aircraft, military and other specialty equipment. Below are basic guidelines.

Circuit Breaker Derating Required

This table lists the maximum continuous current carrying capacity for Siemens breakers at 400Hz. Due to the increased resistance of the copper sections resulting from the skin effect produced by eddy currents at these frequencies, circuit breakers in many cases require derating. The thermal derating on these devices is based upon 100%, three phase application in open air in a maximum of 40°C (104°F) with 48 in. (1219 mm) of the specified cable or bus at the line and load side. Additional derating of not less than 20% will be required if the circuit breaker is to be utilized in an enclosure. Further derating may be required if the enclosure

ambient temperature exceeds 40°C (104°F).

Cable and Bus Sizing

The cable and bus sizes to be utilized at 400Hz are not based on standard National Electric Codes tables for 60Hz application. Larger cross sections are necessary at 400Hz. All bus bars specified are based upon mounting the bars in the vertical plane to allow maximum air flow. All bus bars are spaced at a minimum of 0.25 in. (6 mm) apart. Mounting of bus bars in the horizontal plane will necessitate additional drafting. Edgewise orientation of the bus may change the maximum ratings indicated. If additional information is required for other connections of cable or bus, contact Siemens for information.

Application Recommendations

It is recommended that temperatures be measured on the line and load terminals or T-connectors of the center pole. These

are usually the hottest terminals with a balanced load. A maximum temperature of 75°C (35°C over a maximum ambient of 40°C) would verify the particular application. Temperature profiles taken on these breakers can be correlated to ensure that the hottest points within the breaker are within the required temperature limits.

Factory Configuration

When required, molded case circuit breakers may be factory calibrated for 400Hz application. These breakers are specially labeled for 400Hz usage and their nameplate current rating will include the necessary derating factory. The highest "Maximum Continuous Amperes" rating at 400Hz, found in the table below approximates the highest specially calibrated 400Hz nameplate ampere rating available for a given frame size. Contact Siemens for ordering information on other breakers applied in 400Hz systems.

400Hz Breakers

Siemens Breaker Type	Maximum Continuous Ampere Rating At 40°C (104°F) ^②			75°C (167°F) Copper Cable per Pole	
	60HZ		Enclosed After Derating	No of Pieces	Wire Size
	Open Air	Open Air ^③			
ED2, ED4, ED6, BOD, HED4, HED6, CED6, GG, GB	15	15	12	1	#14
	20	20	16	1	#12
	25	25	20	1	#10
	30	30	24	1	#10
	35	35	28	1	#10
	40	40	32	1	#8
	45	43	34	1	#8
	50	48	38	1	#8
	60	57	46	1	#6
	70	67	54	1	#4
	80	76	61	1	#4
	90	86	69	1	#3
	100	95	76	1	#3
QR2, QR2H, HQR2, HQR2H, FD6, FXF6, HFD6, HFXD6, CFD6	110	105	84	1	#2
	125	119	95	1	#1
	70	63	50	1	#4
	80	72	58	1	#4
	90	80	64	1	#3
	100	90	72	1	#3
	110	95	75	1	#2
	125	105	84	1	#1
	150	125	100	1	#1/0
	175	140	112	1	#2/0
	200	160	128	1	#3/0
225	180	144	1	#4/0	
250	200	160	1	250 kcmil	
200	170	136	1	#3/0	
JXD2, JD6, JXD6, HJD6, HJXD6, HHJD6, HHJXD6, CJD6	225	190	152	1	#4/0
	250	210	168	1	250 kcmil
	300	240	192	1	350 kcmil
	350	260	208	1	500 kcmil
	400	300	240	2	#3/0
	200	170	170	2	#3/0
JD6, JXD6, HJD6, HJXD6 100% Rated	225	190	190	2	#4/0
	250	210	210	1	250 kcmil
	300	240	240	1	350 kcmil
	350	260	260	1	500 kcmil
	400	300	300	2	#3/0

Siemens Breaker Type	Maximum Continuous Ampere Rating At 40°C (104°F) ^②			75°C (167°F) Copper Cable per Pole	
	60HZ		Enclosed After Derating	No of Pieces	Wire Size
	Open Air	Open Air ^③			
LD6, LXD6, HLD6, HLXD6, HHL6, HHLXD6, CLD6	250	210	168	1	250 kcmil
	300	240	192	1	350 kcmil
	350	260	208	1	500 kcmil
	400	300	240	2	#3/0
	450	340	272	2	#4/0
	500	375	300	2	250 kcmil
	600	420	336	2	350 kcmil
	250	210	210	1	250 kcmil
LD6, LXD6, HLD6, HLXD6, 100% Rated	300	240	240	1	350 kcmil
	350	260	260	1	500 kcmil
	400	300	300	2	#3/0
	450	340	340	2	#4/0
	500	375	375	2	250 kcmil
	600	420	420	2	350 kcmil
	500	400	320	2	250 kcmil
	600	430	360	2	350 kcmil
MD6, MXD6, HMD6, HMXD6, CMD6	700	500	400	3	250 kcmil
	800	560	448	3	300 kcmil
	500	400	400	2	250 kcmil
	600	430	430	2	350 kcmil
MD6, MXD6, HMD6, HMXD6, CMD6 100% Rated	700	500	500	3	250 kcmil
	800	560	560	3	300 kcmil
	800	560	448	3	300 kcmil
	900	600	480	3	350 kcmil
ND6, NXD6, HND6, HNXD6, CND6	1000	650	520	3	400 kcmil
	1200	780	624	4	350 kcmil
	900	600	600	3	350 kcmil
	1000	650	650	3	400 kcmil
ND6, NXD6, HND6, HNXD6, CND6 100% Rated	1200	780	780	4	350 kcmil
	1200	780	624	4	400 kcmil
	1400	850	680	4	500 kcmil
	1600	960	768	5	500 kcmil
PD6, PXD6, HPD6, HPSD6, CPD6	1200	780	780	4	400 kcmil
	1400	850	850	4	500 kcmil
	1600	960	960	5	500 kcmil
	1600	960	768	5	500 kcmil
PD6, PXD6, HPD6, HPSD6, CPD6 100% Rated	1800	1080	864	5	500 kcmil
	1600	960	768	5	500 kcmil
	1800	1080	864	5	500 kcmil
	2000	1200	960	6	500 kcmil

①The information provided on this page is intended for reference and recommendation only. Because several variables can act on a circuit breaker's performance at the same time, the data above is based less on

controlled testing, than on experience and engineering judgment. Contact Siemens for further information on special conditions and treatment.

②Additional derating may be required if the ambient

temperature is greater than 40°C (104°F).

③Calculated after derating to compensate for the heating of the copper conductor, caused by the skin effect generated by eddy currents produced at 400/415Hz.

Molded Case Circuit Breakers





Notes

7

MOLDED CASE
CIRCUIT BREAKERS

VL Circuit Breakers

Frame Summary and Ratings Table

Frame Family	DG	FG	JG	
				
Continuous Ampere Range	30 to 150A	40 to 250A	70 to 400A	
Number of Poles	2, 3	2, 3	2, 3	
Maximum Voltage Rating	600Y/347	600Y/347	600V	
Type of Protection				
Thermal-Magnetic	◆	◆	◆	
Electronic	◆	◆	◆	
Electronic with LCD	◆	◆	◆	
Motor Circuit Protector	◆	◆	◆	
Molded Case Switch	◆	◆	◆	
100% Rated Breaker	◆	◆	◆	
Interchangeable Trip Unit	—	—	◆	
 W In.(mm)	4.1 (105)		5.5 (139)	
H	7.3 (175)		11 (279)	
D	3.4 (81)		4.2 (102)	
D1	4.2 (107)		5.4 (138)	
Type N – Normal Interrupting Rating ^① , RMS Symmetrical Amperes (kA)				
UL	240Vac	65	65	65
	480Vac	35	35	35
	600Vac ^②	18	18	25
IEC (I _{cu} /I _{cs})	240Vac	65/65	65/65	65/65
	415Vac	40/40	40/40	45/45
	690Vac	12/6	12/6	12/6
DC Voltages – Interrupting Rating (kA)^④				
	250Vdc - 2p	30	30	30
	500Vdc - 3p ^③	18	18	25
Type H – High Interrupting Rating ^① , RMS Symmetrical Amperes (kA)				
UL	240Vac	100	100	100
	480Vac	65	65	65
	600Vac ^②	18	18	25
IEC (I _{cu} /I _{cs})	240Vac	100/75	100/75	100/75
	415Vac	70/70	70/70	70/70
	690Vac	12/6	12/6	15/8
DC Voltages – Interrupting Rating (kA)^④				
	250Vdc - 2p	30	30	30
	500Vdc - 3p ^③	18	25	35
	600Vdc - 3p ^②	42	42	65
Type L – Very High Interrupting Rating ^① , RMS Symmetrical Amperes (kA)				
UL	240Vac	200	200	200
	480Vac	100	100	100
	600Vac ^②	18	18	25
IEC (I _{cu} /I _{cs})	240Vac	200/150	200/150	200/150
	415Vac	100/75	100/75	100/75
	690Vac	12/6	12/6	15/8
DC Voltages – Interrupting Rating (kA)^④				
	250Vdc - 2p	30	30	30
	500Vdc - 3p ^③	18	30	35

① UL does not recognize AIC ratings for Molded Case Switches or Motor Circuit Protectors.

② For 600 VDC breakers see page 7-136.





③ 500Vdc nominal, 600Vdc max. for ungrounded DC UPS systems.

④ DC Interruption Ratings do not apply to electronic trip circuit breakers.

⑤ DG & FG breakers are 600Y/347V.

VL Circuit Breakers

Frame Summary and Ratings Table — Continued

Frame Family	LG	MG	NG	PG	
					
Continuous Ampere Range	150 to 600A	200 to 800A	300 to 1200A	400 to 1600A	
Number of Poles	2, 3	2, 3	2, 3	3	
Maximum Voltage Rating	600V	600V	600V	600V	
Type of Protection					
Thermal-Magnetic	◆	◆	◆	◆	
Electronic	◆	◆	◆	◆	
Electronic with LCD	◆	◆	◆	◆	
Motor Circuit Protector	◆	◆	◆	—	
Molded Case Switch	◆	◆	◆	◆	
100% Rated	400/500 Amp	◆	◆	◆	
Interchangeable Trip Unit	—	◆	◆	◆ ^②	
 W In.(mm)	5.5 (139)	7.5 (190)	9 (229)		
H	11 (279) ^②	16 (406)	16 (406)		
D	4.2 (102)	4.7 (114)	6.2 (157)		
D1	5.4 (138)	5.9 (151)	8.1 (207)		
Type N – Normal Interrupting Rating ^① , RMS Symmetrical Amperes (kA)					
UL	240Vac	65	65	65	65
	480Vac	35	35	35	35
	600Vac	18	25	25	25
IEC (I _{cu} /I _{cs})	240Vac	65/65	65/65	65/65	65/65
	415Vac	45/45	50/50	50/25	50/25
	690Vac	12/6	20/10	20/10	20/10
DC Voltages – Interrupting Rating (kA)^④					
	250Vdc - 2p	30	22	22	22
	500Vdc - 3p ^③	25	35	35	35
Type H – High Interrupting Rating ^① , RMS Symmetrical Amperes (kA)					
UL	240Vac	100	100	100	100
	480Vac	65	65	65	65
	600Vac	18 ^②	35	35	35
IEC (I _{cu} /I _{cs})	240Vac	100/75	100/75	100/75	100/50
	415Vac	70/70	70/70	70/35	70/35
	690Vac	15/8	30/15	30/15	30/15
DC Voltages – Interrupting Rating (kA)^④					
	250Vdc - 2p	30	25	25	25
	500Vdc - 3p ^③	35	50	50	50
	600Vdc - 3p ^⑤	65	65	65	65
Type L – Very High Interrupting Rating ^① , RMS Symmetrical Amperes (kA)					
UL	240Vac	200	200	200	200
	480Vac	100	100	100	100
	600Vac	18	50	65	65
IEC (I _{cu} /I _{cs})	240Vac	200/150	200/150	200/150	200/150
	415Vac	100/75	100/75	100/75	100/75
	690Vac	15/8	35/17	35/17	35/17
DC Voltages – Interrupting Rating (kA)^④					
	250Vdc - 2p	30	42	42	42
	500Vdc - 3p ^③	35	65	65	65

7
MOLDED CASE
CIRCUIT BREAKERS

① UL does not recognize AIC ratings for Molded Case Switches or Motor Circuit Protectors.
② 25kA available in a special version. Standard breakers rated 18kA. See page 7-120.

③ 500Vdc nominal, 600Vdc max. for ungrounded DC UPS systems.
④ DC Interruption Ratings do not apply to electronic trip circuit breakers.

⑤ For 600 VDC breakers see page 7-136.
⑥ Thermal-magnetic available non-interchangeable only.
⑦ 13.6" with extended shields.

VL Circuit Breakers

The interchangeability of the VL circuit breaker trip units allow for easy conversion from any of 3 types of protection. They are thermal-magnetic, electronic, or electronic with a built-in LCD. The thermal-magnetic trip unit features an adjustable magnetic trip setting. The electronic trip units are microprocessor based true RMS sensing devices and are available with a variety of adjustable trip settings, configurations, and infor-

mation menus. With precise control over the circuit breaker functions and access to system status, diagnostics, and information, these trip units allow for unsurpassed flexibility in circuit coordination.

An example of coordination is the out of the box Ground Fault function on the Model 555 trip units. The pick-up and time delay settings are set at the

factory for each frame and do not overlap with the settings on the other frames. Therefore, when VL breakers are used together in a system the GF protection is automatically coordinated. The user also has the ability to program a custom coordination scheme with adjustable settings on both the 555 and 586 trip units.

Trip Unit Functions	VL Trip Units							
	Model 525	Model 555				Model 586		
	Thermal-magnetic	Electronic LI	Electronic LIG	Electronic LSI	Electronic LSIG	Electronic with LCD LSI	Electronic with LCD LSIG	Electronic with LCD LSI + G alarm only
Continuous Current Setting (I_r)	Fixed	◆	◆	◆	◆	◆	◆	◆
Long Time Delay (t_r)	□	◆	◆	◆	◆	◆	◆	◆
Instantaneous Function	●	●	●	●	●	(ON/OFF)	(ON/OFF)	(ON/OFF)
Instantaneous Pickup (I_i)	◆	◆	◆	◆	◆	◆	◆	◆
Short Time Function	□	□	□	●	●	(ON/OFF)	(ON/OFF)	(ON/OFF)
Short Time Pick-up (I_{sd})	□	□	□	◆	◆	◆	◆	◆
Short Time Delay (t_{sd})	□	□	□	◆	◆	◆	◆	◆
Ground Fault Pick-up (I_g)	□	□	◆	□	◆	□	◆	□
Ground Fault Delay (t_g)	□	□	◆	□	◆	□	◆	□
Ground Fault Alarm Pick-up	□	□	□	□	□	□	◆	◆
Ground Fault Alarm Delay	□	□	□	□	□	□	◆	◆
Alarm & Status Indicator	□	●	●	●	●	●	●	●
Built-in Display (LCD)	□	□	□	□	□	●	●	●
Pre-Trip Alarm ^①	□	●	●	●	●	●	●	●
Last Trip Information	□	● ^①	● ^①	● ^①	● ^①	●	●	●
Zone Selective ^①	□	●	●	●	●	●	●	●
Communications ^①	□	●	●	●	●	●	●	●

◆ Adjustable setting
 ● This feature is included
 □ Feature is not included.
 ① Requires a COMPRO20 or COMMOD21 module in a communication system.

Continuous Amps Rating (I_r)

This setting is the continuous current that the breaker will carry without tripping. It can be set up to 100% of the trip unit's nominal rating (I_n).

Long Time Delay (t_r)

Sometimes referred to as the "overload" position, this function controls the breaker's "pause-in-tripping" time. It allows low level, temporary inrush currents such as those encountered when starting a motor to pass without tripping. The time delay begins when the current reaches $6 \times I_r$.

Instantaneous Pick-up (I_i)

This function sets the breaker to trip instantaneously during high fault conditions. This function may be turned off on Model 586 trip units. Turning this function off will enable an instantaneous trip

override function to ensure self protection of circuit breaker.

Short Time Pick-Up (I_{sd})

This function controls the level of fault current the breaker will carry for a short time without tripping, thus allowing downstream devices to clear short circuits ahead of up-stream protection. It may be defeated (turned-off) on Model 586 trip units.

Short Time Delay (t_{sd})

This controls the interval of time the breaker will remain closed against a fault (at the Short Time Pick-up current level) without tripping. The time delay may be set at fixed points or at short time intervals based on I^2t curves. This function is used with the Short Time Pick-up to achieve selectivity and better system coordination.

Ground Fault Pick-Up (I_g)

This setting controls the level of ground fault current that will cause the breaker to trip. Model 555 Electronic Trip Units act on the residual current to sense ground current. The Model 586 Electronic Trip Unit is programmable and allows the user to select either the residual current method or direct detection (via a separate current transformer) to detect ground current.

Ground Fault Time Delay (t_g)

This controls the interval of time the breaker will remain closed after a ground fault is detected (at the Ground Fault Pick-up current level) without tripping.

VL Circuit Breakers

Thermal-Magnetic trip units, Model 525, combine the inverse time element design for low level overloads, and instantaneous magnetic action for short circuit protection. The standard unit has preset overload protection and an adjustable instantaneous trip setting, with 6 set points. Thermal-Magnetic trip units are available throughout the VL family, from 50 to 1600A.

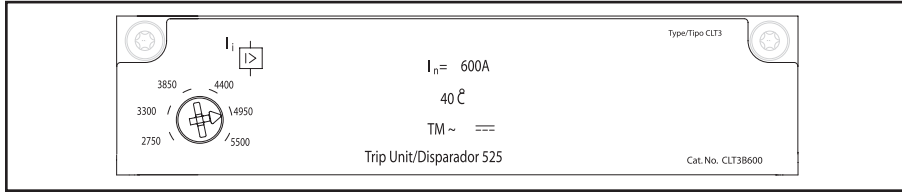

Electronic Trip Units

Electronic trip units are available through the VL family, from 60A (which can be set as low as 30A) up through 1600A. They are also available in four trip configurations (LI, LIG, LSI, LSIG) and features can include a built-in LCD display.

microprocessor is in operating and another indicates an overload condition. For ease-of-use and to insure proper coordination, the set points for the continuous current are shown on the face of these trip units in amps.

On the Model 555 Electronic Trip Unit a flashing LED confirms that the

On the Model 586, the LCD version, the current in each phase is continuously shown on the display. Unlike many

displays, no secondary or auxiliary voltage is required as long as the breaker is energized and a minimal load current is present. These trip units can also indicate the "last trip" status (date, time, amps) when they're connected to a PC via one of our communications modules. Without being connected via a communication module, the last trip status can be viewed on Model 586 trip units (no time stamp).

Typical Trip Unit Labeling and Adjustment Positions

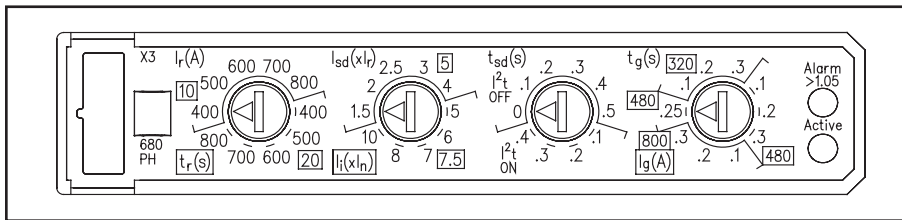

Model 555 Electronic Trip Unit with LSIG trip functions

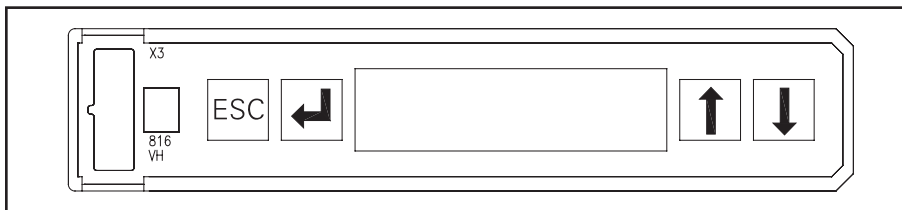

Model 586 Electronic Trip Unit has an LCD display

VL Circuit Breakers

DG 150A Frame, VL Series

Selection

Ordering Information

Complete Assembled Breaker

A complete factory assembled DG breaker includes the frame, trip unit, and standard line and load connectors, all factory installed and shipped as a complete breaker. Assembled breakers are only available with standard connectors.

For DC applications, use thermal magnetic trip unit only.

Breakers are suitable for reverse feed applications.

For special applications, refer to page 7-156.

Mounting hardware is included with each frame or complete breaker.

For 100% rated breakers with a non-interchangeable trip unit, change the 3rd character of the catalog number to "W". Available in electronic and electronic with LCD only.

HACR rated.

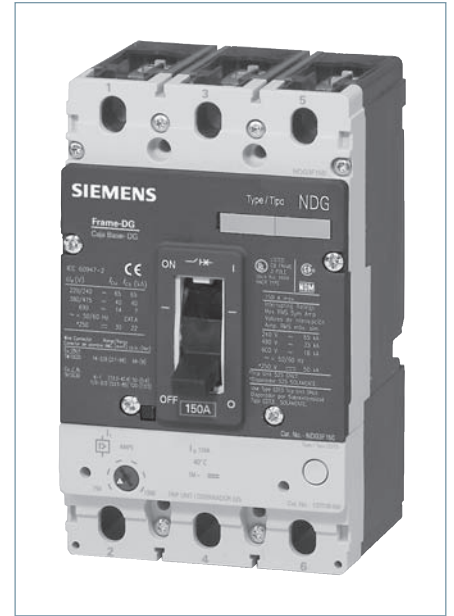

Interrupting Ratings

Interrupting Class	Breaker Type	RMS Symmetrical Amperes (KA)										
		UL 489					IEC 60947-2					
		Volts AC (50/60 Hz)			Volts DC		Volts AC (50/60 Hz)					
		240	480	600Y/347	250	500	220/240		380/415		690	
N	NDGB	65	35	18	30	18	65	65	40	40	12	6
H	HDGB	100	65	18	30	18	100	75	70	70	12	6
L	LDGB	200	100	18	30	18	200	150	100	75	12	6

Dimensions, inches (mm)

Number of Poles	Width	Length	Depth	To Handle D1
2, 3	4.1 (105)	6.9 (175)	3.4 (81)	4.2(107)

Connectors for 75°C Wire

Construction	Ampere Rating	Wire Range	No. of cables per connector	Catalog Number
Steel	30-150	#8-1/0 Cu	1	3TW1DG20 ^②
Aluminum	30-150	#6-3/0 Al/Cu	1	3TA1DG30 ^{①②}
Copper	30-150	#6-3/0 Cu	1	3TC1DG30 ^{②④}
Distribution Lugs				
	30-150	#14-#2 Al/Cu (3pcs. Max)	3	3TA3DG02 ^②
	30-150	#14-#4 Cu, #14-#6 Al	6	3TA6DG04 ^②
Compression Lugs				
	30-150	#14-2/0 kcmil Al/Cu	-	2CLD20 ^③
	30-150	#14-2/0 kcmil Al/Cu	-	3CLD20 ^②

① Standard connector supplied with complete breakers.

② Kit consists of 3 terminal connectors.

③ 2 Lugs for 2-pole breakers.

④ Required for 100% rated DG breakers. Requires 90°C Cu cable sized at 75°C ampacity

Approx. Shipping Weight, lbs. (kg)

Poles	Frame	Trip Unit		Complete Breaker
		Thermal-Mag.	Electronic	
2, 3	3.7 (1.7)	2.2 (1.0)	2.6 (1.2)	5.9 (2.7)

DG Thermal-Magnetic, Instantaneous Trip Adjustment Range

Trip Unit Continuous Amp Rating (I _n)	Instantaneous Overcurrent Setting (I _t)	
	Min.	Max.
50	450	600
60	450	600
70	450	700
80	450	800
90	500	1000
100	500	1000
110	550	1100
125	625	1250
150	800	1600

Note: Each breaker has 6 trip settings in this range.

External Accessories pages 7-137 through 7-151

VL Circuit Breakers

DG 150A Thermal-Magnetic Trip Unit

Selection

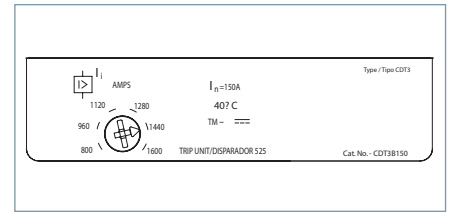

Model 525 Trip Unit

DG 150A Frame 2-Pole with Thermal-Magnetic Trip Unit

Continuous Ampere Rating	COMPLETE FACTORY ASSEMBLED CIRCUIT BREAKER		
	N-Interrupting Class	H-Interrupting Class	L-Interrupting Class
	Catalog Number	Catalog Number	Catalog Number
50	NDK2B050L	HDK2B050L	LDK2B050L
60	NDK2B060L	HDK2B060L	LDK2B060L
70	NDK2B070L	HDK2B070L	LDK2B070L
80	NDK2B080L	HDK2B080L	LDK2B080L
90	NDK2B090L	HDK2B090L	LDK2B090L
100	NDK2B100L	HDK2B100L	LDK2B100L
110	NDK2B110L	HDK2B110L	LDK2B110L
125	NDK2B125L	HDK2B125L	LDK2B125L
150	NDK2B150L	HDK2B150L	LDK2B150L

DG 150A Frame 3-Pole with Thermal-Magnetic Trip Unit

Continuous Ampere Rating	COMPLETE FACTORY ASSEMBLED CIRCUIT BREAKER		
	N-Interrupting Class	H-Interrupting Class	L-Interrupting Class
	Catalog Number	Catalog Number	Catalog Number
50	NDK3B050L	HDK3B050L	LDK3B050L
60	NDK3B060L	HDK3B060L	LDK3B060L
70	NDK3B070L	HDK3B070L	LDK3B070L
80	NDK3B080L	HDK3B080L	LDK3B080L
90	NDK3B090L	HDK3B090L	LDK3B090L
100	NDK3B100L	HDK3B100L	LDK3B100L
110	NDK3B110L	HDK3B110L	LDK3B110L
125	NDK3B125L	HDK3B125L	LDK3B125L
150	NDK3B150L	HDK3B150L	LDK3B150L

VL Circuit Breakers

DG 150A Electronic Trip Units

Selection

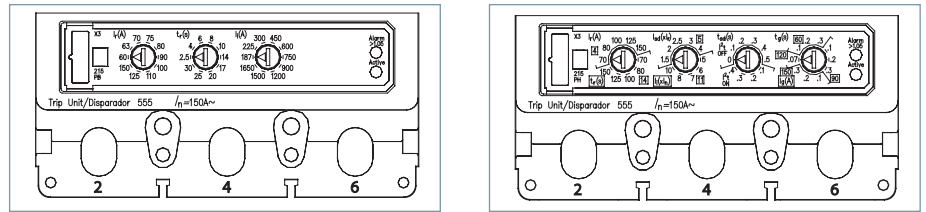

Model 555 Trip Units

DG 150A Frame 3-Pole Electronic Trip Unit^①

Continuous Ampere Rating	COMPLETE FACTORY ASSEMBLED CIRCUIT BREAKER		
	N-Interrupting Class	H-Interrupting Class	L-Interrupting Class
	Catalog Number	Catalog Number	Catalog Number
ELECTRONIC LI TRIP			
60	NDK3R060L	HDK3R060L	LDK3R060L
100	NDK3R100L	HDK3R100L	LDK3R100L
150	NDK3R150L	HDK3R150L	LDK3R150L
ELECTRONIC LSI TRIP			
60	NDK3T060L	HDK3T060L	LDK3T060L
100	NDK3T100L	HDK3T100L	LDK3T100L
150	NDK3T150L	HDK3T150L	LDK3T150L
ELECTRONIC LSIG TRIP			
60	NDK3V060L	HDK3V060L	LDK3V060L
100	NDK3V100L	HDK3V100L	LDK3V100L
150	NDK3V150L	HDK3V150L	LDK3V150L
ELECTRONIC LIG TRIP			
60	NDK3W060L	HDK3W060L	LDK3W060L
100	NDK3W100L	HDK3W100L	LDK3W100L
150	NDK3W150L	HDK3W150L	LDK3W150L

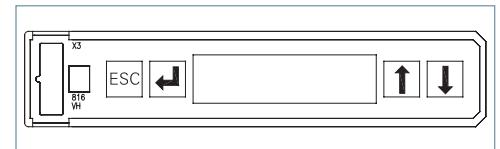

Model 586 Trip Unit

DG 150A Frame 3-Pole Electronic LCD Trip Unit^①

Continuous Ampere Rating	COMPLETE FACTORY ASSEMBLED CIRCUIT BREAKER		
	N-Interrupting Class	H-Interrupting Class	L-Interrupting Class
	Catalog Number	Catalog Number	Catalog Number
LCD ELECTRONIC LSI TRIP			
60	NDK3A060L	HDK3A060L	LDK3A060L
100	NDK3A100L	HDK3A100L	LDK3A100L
150	NDK3A150L	HDK3A150L	LDK3A150L
LCD ELECTRONIC LSIG TRIP			
60	NDK3G060L	HDK3G060L	LDK3G060L
100	NDK3G100L	HDK3G100L	LDK3G100L
150	NDK3G150L	HDK3G150L	LDK3G150L
LCD ELECTRONIC LSI TRIP + GF ALARM ONLY			
60	NDK3K060L	HDK3K060L	LDK3K060L
100	NDK3K100L	HDK3K100L	LDK3K100L
150	NDK3K150L	HDK3K150L	LDK3K150L

^① Due to the location of the magnetic tripping solenoid, the left accessory pocket is not available for accessories.

7 MOLDED CASE CIRCUIT BREAKERS

VL Circuit Breakers

Internal Accessories for DG 150A and FG 250A Frames

Selection

Auxiliary Switch and Alarm Switch Combination Kits

Description	Mounting Pocket ^①	Catalog Number
1 Alarm Switch 1A/B ^③ Bases AMBL2 & AMBL3	Left, Right ^②	ASKL1
2 Aux. Switches 1A + 1B Bases AMBL1	Left, Right	ASKL2
2 Aux. + 1 Alarm Switch 1A + 1B, 1A/B ^③ Bases AMBL2 & AMBL3	Left, Right ^②	ASKL3

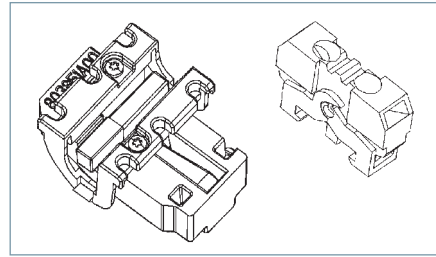

Auxiliary/Alarm Switch Mounting Base Only

Description	Mounting Pocket	Catalog Number
Up to 3 Auxiliary Switches	Left, Right	AMBL1
2 Aux. + 1 Alarm Switch	Left Pocket Only	AMBL2
2 Aux. + 1 Alarm Switch	Right Pocket Only	AMBL3

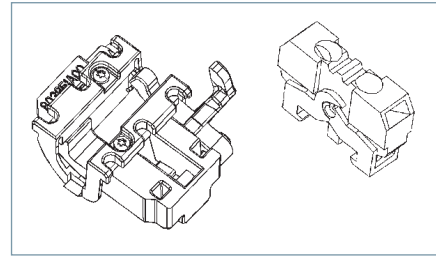

Auxiliary/Alarm Switch Only Common to DG - PG Frames

Description	Catalog Number
1 Normally Open Contact (1A)	ASWPA
1 Normally Closed Contact (1B)	ASWPB

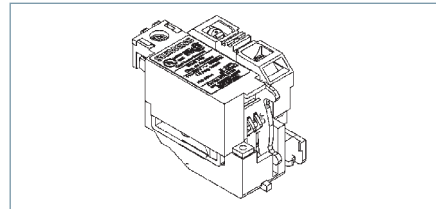

Shunt Trips

Description	Mounting Pocket	Catalog Number
24 VDC	Right Pocket Only	STRLB24DC
48-60 VDC		STRLC60DC
110-127 VDC		STRLD125DC
220-250 VDC		STRLE250DC
48-60 VAC		STRLM60
110-127 VAC		STRLN120
208-277 VAC		STRLS277
380-600 VAC		STRLV600



Undervoltage Release

Description	Mounting Pocket	Catalog Number
12 VDC	Right Pocket Only	UVRLA12DC
24 VDC		UVRLB24DC
48 VDC		UVRLC48DC
60 VDC		UVRLG60DC
110-127 VDC		UVRLD125DC
220-250 VDC		UVRLE250DC
24 VAC		UVRLI24
110-127 VAC		UVRLN120
220-240 VAC		UVRLR240
208 VAC		UVRLP208
277 VAC		UVRLS277
380-415 VAC		UVRLT415
440-480 VAC		UVRLU480

① Refer to the "Accessory Locations" chart on page 7-152 for guidelines and limitations about which pockets may be used for accessory combinations.

② These kits include two bases, one for mounting switches in the left pocket and another for mounting in the right.

③ Includes 1A and 1B contact for alarm purposes, only one of which may be installed at any time.

'A' refers to a normally open contact (open when the breaker contacts are open).

'B' refers to a normally closed contact (closed when the breaker contacts are open).

External Accessories pages 7-137 through 7-151

VL Circuit Breakers

FG 250A Frame, VL Series

Selection/Dimensions

Ordering Information

Complete Assembled Breaker

A complete factory assembled FG breaker includes the frame, trip unit, and standard line and load connectors, all factory installed and shipped as a complete breaker. Assembled breakers are available only with standard connectors.

For DC applications, use thermal magnetic trip unit only.

Breakers are suitable for reverse feed applications.

For special applications, refer to page 7-156.

Mounting hardware is included with each frame or complete breaker.

HACR rated.



Interrupting Ratings

Breaker Type	RMS Symmetrical Amperes (KA)										
	UL 489					IEC 60947-2					
	Volts AC (50/60 Hz)			Volts DC		Volts AC (50/60 Hz)					
	240	480	600Y/347	250	500	220/240		380/415		690	
					I _{CU}	I _{CS}	I _{CU}	I _{CS}	I _{CU}	I _{CS}	
NFG	65	35	18	30	18	65	65	40	40	12	6
HFG	100	65	18	30	18	100	75	70	70	12	6
LFG	200	100	18	30	18	200	150	100	75	12	6

Connectors for 75°C Wire

Construction	Ampere Rating	Wire Range	No. of cables per connector	Catalog Number
Steel	50-250	#4-350 kcmil Cu	1	3TW1FG350 ^②
Aluminum ^①	50-250	#4-350 kcmil Al/Cu	1	3TAW1FG350 ^②
Copper	50-250	#4-350 kcmil Cu	1	3TCW1FG350 ^②
Distribution Lugs				
	50-250	#12-2/0 Cu/Al	3	3TA3FG20 ^②
	50-250	#14-#4 Cu/Al	6	3TA6FG04 ^②

^① Standard connector supplied with complete breakers.

^② Kit consists of 3 terminal connectors.

^③ 2 Lugs for 2-pole breakers.

^④ 3 Lugs for 3-pole breakers.

FG Thermal-Magnetic, Instantaneous Trip Adjustment Range

Trip Unit Continuous Amp Rating (I _n)	Instantaneous Overcurrent Setting (I _b)	
	Min.	Max.
100	625	1250
110	800	1600
125	800	1600
150	800	1600
175	1000	2000
200	1000	2000
225	1250	2500
250	1250	2500

Note: Each breaker has 6 trip settings in this range.

Dimensions, inches (mm)

Number of Poles	Width	Length	Depth	To Handle D1
2, 3	4.1 (105)	6.9 (175)	3.4 (81)	4.2 (107)

Shipping Weight, lbs. (kg)

Poles	Frame	Trip Unit		Complete Breaker
		Thermal-Mag.	Electronic	
2, 3	4.0 (1.8)	2.2 (1.0)	2.6 (1.2)	6.2 (2.8)

VL Circuit Breakers

FG 250A Thermal-Magnetic Trip Unit

Selection

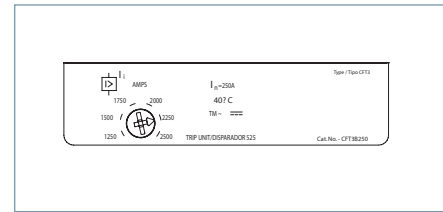

Model 525 Trip Unit

FG 250A Frame 2-Pole with Thermal-Magnetic Trip Unit

Continuous Ampere Rating	COMPLETE FACTORY ASSEMBLED CIRCUIT BREAKER		
	N-Interrupting Class	H-Interrupting Class	L-Interrupting Class
	Catalog Number	Catalog Number	Catalog Number
100	NFK2B100L	HFK2B100L	LFK2B100L
110	NFK2B110L	HFK2B110L	LFK2B110L
125	NFK2B125L	HFK2B125L	LFK2B125L
150	NFK2B150L	HFK2B150L	LFK2B150L
175	NFK2B175L	HFK2B175L	LFK2B175L
200	NFK2B200L	HFK2B200L	LFK2B200L
225	NFK2B225L	HFK2B225L	LFK2B225L
250	NFK2B250L	HFK2B250L	LFK2B250L

FG 250A Frame 3-Pole with Thermal-Magnetic Trip Unit

Continuous Ampere Rating	COMPLETE FACTORY ASSEMBLED CIRCUIT BREAKER		
	N-Interrupting Class	H-Interrupting Class	L-Interrupting Class
	Catalog Number	Catalog Number	Catalog Number
100	NFK3B100L	HFK3B100L	LFK3B100L
110	NFK3B110L	HFK3B110L	LFK3B110L
125	NFK3B125L	HFK3B125L	LFK3B125L
150	NFK3B150L	HFK3B150L	LFK3B150L
175	NFK3B175L	HFK3B175L	LFK3B175L
200	NFK3B200L	HFK3B200L	LFK3B200L
225	NFK3B225L	HFK3B225L	LFK3B225L
250	NFK3B250L	HFK3B250L	LFK3B250L

VL Circuit Breakers

FG 250A Electronic Trip Units

Selection

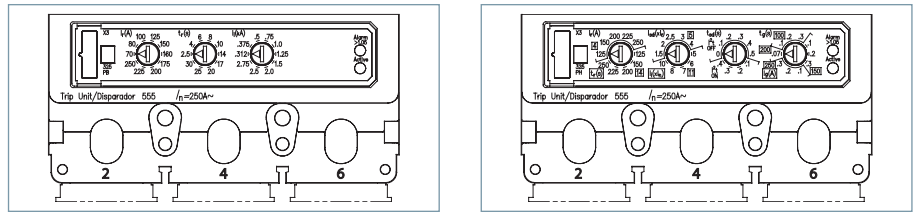

Model 555 Trip Units

FG 250A Frame 3-Pole Electronic Trip Unit^①

Continuous Ampere Rating	COMPLETE FACTORY ASSEMBLED CIRCUIT BREAKER		
	N-Interrupting Class	H-Interrupting Class	L-Interrupting Class
	Catalog Number	Catalog Number	Catalog Number
ELECTRONIC LI TRIP			
100	NFK3R100L	HFK3R100L	LFK3R100L
150	NFK3R150L	HFK3R150L	LFK3R150L
250	NFK3R250L	HFK3R250L	LFK3R250L
ELECTRONIC LSI TRIP			
100	NFK3T100L	HFK3T100L	LFK3T100L
150	NFK3T150L	HFK3T150L	LFK3T150L
250	NFK3T250L	HFK3T250L	LFK3T250L
ELECTRONIC LSIG TRIP			
100	NFK3V100L	HFK3V100L	LFK3V100L
150	NFK3V150L	HFK3V150L	LFK3V150L
250	NFK3V250L	HFK3V250L	LFK3V250L
ELECTRONIC LIG TRIP			
100	NFK3W100L	HFK3W100L	LFK3W100L
150	NFK3W150L	HFK3W150L	LFK3W150L
250	NFK3W250L	HFK3W250L	LFK3W250L

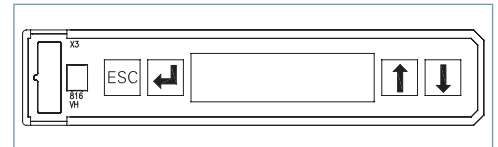

Model 586 Trip Unit

FG 250A Frame 3-Pole Electronic LCD Trip Unit^①

Continuous Ampere Rating	COMPLETE FACTORY ASSEMBLED CIRCUIT BREAKER		
	N-Interrupting Class	H-Interrupting Class	L-Interrupting Class
	Catalog Number	Catalog Number	Catalog Number
LCD ELECTRONIC LSI TRIP			
100	NFK3A100L	HFK3A100L	LFK3A100L
150	NFK3A150L	HFK3A150L	LFK3A150L
250	NFK3A250L	HFK3A250L	LFK3A250L
LCD ELECTRONIC LSIG TRIP			
100	NFK3G100L	HFK3G100L	LFK3G100L
150	NFK3G150L	HFK3G150L	LFK3G150L
250	NFK3G250L	HFK3G250L	LFK3G250L
LCD ELECTRONIC LSI TRIP + GF ALARM ONLY			
100	NFK3K100L	HFK3K100L	LFK3K100L
150	NFK3K150L	HFK3K150L	LFK3K150L
250	NFK3K250L	HFK3K250L	LFK3K250L

^① Due to the location of the magnetic tripping solenoid, the left accessory pocket is not available for accessories.

7
MOLDED CASE
CIRCUIT BREAKERS

VL Circuit Breakers

Internal Accessories for DG 150A and FG 250A Frames

Selection

Auxiliary Switch and Alarm Switch Combination Kits

Description	Mounting Pocket ^①	Catalog Number
1 Alarm Switch 1A/B ^③ Bases AMBL2 & AMBL3	Left, Right ^②	ASKL1
2 Aux. Switches 1A + 1B Bases AMBL1	Left, Right	ASKL2
2 Aux. + 1 Alarm Switches 1A + 1B, 1A/B ^③ Bases AMBL2 & AMBL3	Left, Right ^②	ASKL3

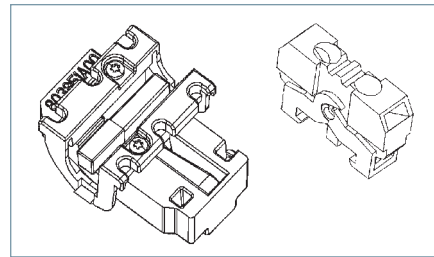

Auxiliary/Alarm Switch Mounting Base Only

Description	Mounting Pocket	Catalog Number
Up to 3 Auxiliary Switches	Left, Right	AMBL1
2 Aux. + 1 Alarm Switch	Left Pocket Only	AMBL2
2 Aux. + 1 Alarm Switch	Right Pocket Only	AMBL3

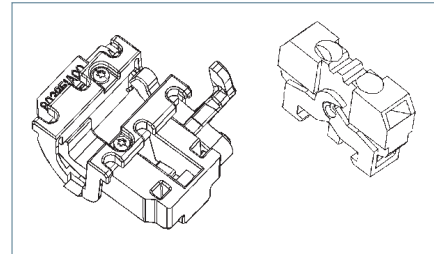

Auxiliary/Alarm Switch Only

Common to DG - PG Frames

Description	Catalog Number
1 Normally Open Contact (1A)	ASWPA
1 Normally Closed Contact (1B)	ASWPB

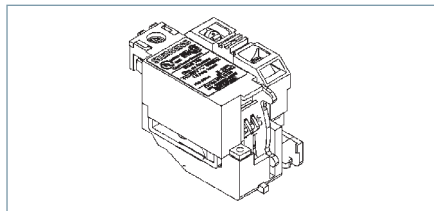

Shunt Trips

Description	Mounting Pocket	Catalog Number
24 VDC	Right Pocket Only	STRLB24DC
48-60 VDC		STRLC60DC
110-127 VDC		STRLD125DC
220-250 VDC		STRLE250DC
48-60 VAC		STRLM60
110-127 VAC		STRLN120
208-277 VAC		STRLS277
380-600 VAC		STRLV600



Undervoltage Release

Description	Mounting Pocket	Catalog Number
12 VDC	Right Pocket Only	UVRLA12DC
24 VDC		UVRLB24DC
48 VDC		UVRLC48DC
60 VDC		UVRLG60DC
110-127 VDC		UVRLD125DC
220-250 VDC		UVRLE250DC
24 VAC		UVRL24
110-127 VAC		UVRLN120
220-240 VAC		UVRLR240
208 VAC		UVRLP208
277 VAC		UVRLS277
380-415 VAC		UVRLT415
440-480 VAC		UVRLU480

① Refer to the "Accessory Locations" chart on page 7-152 for guidelines and limitations about which pockets may be used for accessory combinations.
 ② These kits include two bases, one for mounting switches in the left pocket and another for mounting in the right.
 ③ Includes 1A and 1B contact for alarm purposes, only one of which may be installed at any time.
 'A' refers to a normally open contact (open when the breaker contacts are open).
 'B' refers to a normally closed contact (closed when the breaker contacts are open).

External Accessories pages 7-137 through 7-151

VL Circuit Breakers

JG 400A Frame, VL Series

Selection/Dimensions

Ordering Information

Complete Assembled Breaker

A complete factory assembled JG breaker includes the frame, trip unit, and standard line and load connectors, all factory installed and shipped as a complete breaker. Assembled breakers are available only with standard connectors.

For any other configuration, order the frame, trip unit, and terminals as separate items.

For DC applications, use thermal magnetic trip unit only.

For reverse feed applications, select non-interchangeable trip breakers only. For non-interchangeable trip breakers, change the third digit of the catalog number to "X" for standard breakers.

For 100% rated breakers with a non-interchangeable trip unit, change the 3rd character of the catalog number to "Y" (3-pole only).

For special applications, refer to page 7-156.

Mounting hardware is included with each frame or complete breaker. HACR rated.



Dimensions, inches (mm)

Number of Poles	Width	Length	Depth	To Handle D1
2, 3	5.5 (139)	11 (279)	4.2 (102)	5.4 (138)

Shipping Weight, lbs. (kg)

Poles	Frame	Trip Unit		Complete Breaker
		Thermal-Mag.	Electronic	
2, 3	9.3 (4.2)	4.0 (1.8)	4.0 (1.8)	12.6 (5.7)

Interrupting Ratings

Interrupting Class	Breaker Type	RMS Symmetrical Amperes (KA)										
		UL 489 AIR (File E10848)					IEC 60947-2					
		Volts AC (50/60 Hz)			Volts DC		Volts AC (50/60 Hz)					
		240	480	600	250	500	220/240		380/415		690	
					I _{cu}	I _{cs}	I _{cu}	I _{cs}	I _{cu}	I _{cs}		
N	NJGA	65	35	25	30	25	65	65	45	45	12	6
H	HJGA	100	65	25	30	35	100	75	70	70	15	8
L	LJGA	200	100	25	30	35	200	150	100	75	15	8

Connectors for 75°C Wire

Construction	Ampere Rating	Wire Range	No. of cables per connector	Catalog Number
Steel	70-400	1/0-600 kcmil Cu	1	3TW1JG600 ^②
Aluminum	70-400	3/0-250 kcmil Al/Cu	2	3TA2JG250 ^{①②}
Aluminum	70-400	250-750 kcmil Al	1	3TA1JG750 ^②
Aluminum	70-400	3/0-600 kcmil Cu	1	3TA1JG750 ^②
Copper	70-400	3/0-600 kcmil Cu	1	TC1JG750 ^③
Copper	70-400	3/0-250 kcmil Cu	2	TC2JG250 ^③
Distribution Lugs				
	70-400	#14-4 Cu	12	3TA12JG04 ^②
	70-400	#14-2/0 Al/Cu	6	3TA6JG20 ^②
Compression Lugs				
	70-400	#6-350 kcmil	—	3CLJ350 ^②
	70-400	250-600 kcmil	—	3CLJ600 ^②

① Standard construction supplied for each breaker.

② Kit consists of 3 terminal connectors.

③ Required for 100% rated JG breakers. Requires 90°C Cu cable sized at 75°C ampacity.

JG Thermal-Magnetic, Instantaneous Trip Adjustment Range

Trip Unit Continuous Amp Rating (I _n)	Instantaneous Overcurrent Setting (I _i)	
	Min.	Max.
250	1250	2500
300	1500	3000
350	1750	3500
400	2000	4000

Note: Each breaker has 6 trip settings in this range.

7 MOLDED CASE CIRCUIT BREAKERS

External Accessories pages 7-137 through 7-151

VL Circuit Breakers

JG 400A Thermal-Magnetic Trip Unit

Selection

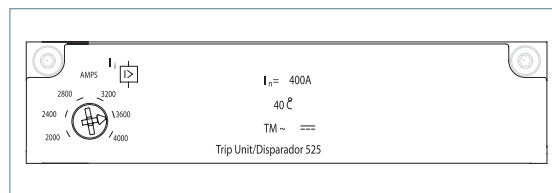

Model 525 Trip Unit

JG 400A Frame 2-Pole with Thermal-Magnetic Trip Unit

Continuous Ampere Rating	N-Interrupting Class	H-Interrupting Class	L-Interrupting Class	Catalog Number
	Catalog Number	Catalog Number	Catalog Number	
	FRAME ONLY			
	NJG2F400	HJG2F400	LJG2F400	
	COMPLETE FACTORY ASSEMBLED CIRCUIT BREAKER			TRIP UNIT ONLY
250	NJG2B250L	HJG2B250L	LJG2B250L	CJT2B250
300	NJG2B300L	HJG2B300L	LJG2B300L	CJT2B300
350	NJG2B350L	HJG2B350L	LJG2B350L	CJT2B350
400	NJG2B400L	HJG2B400L	LJG2B400L	CJT2B400

JG 400A Frame 3-Pole with Thermal-Magnetic Trip Unit

Continuous Ampere Rating	N-Interrupting Class	H-Interrupting Class	L-Interrupting Class	Catalog Number
	Catalog Number	Catalog Number	Catalog Number	
	FRAME ONLY			
	NJG3F400	HJG3F400	LJG3F400	
	COMPLETE FACTORY ASSEMBLED CIRCUIT BREAKER			TRIP UNIT ONLY
250	NJG3B250L	HJG3B250L	LJG3B250L	CJT3B250
300	NJG3B300L	HJG3B300L	LJG3B300L	CJT3B300
350	NJG3B350L	HJG3B350L	LJG3B350L	CJT3B350
400	NJG3B400L	HJG3B400L	LJG3B400L	CJT3B400

JJ 400A Frame 240V max., 2-pole with Thermal-Magnetic Non-Interchangeable Trip Unit^①

Continuous Ampere Rating	N-Interrupting Class
	Catalog Number
	COMPLETE BREAKER
250	NJJ2B250
300	NJJ2B300
350	NJJ2B350
400	NJJ2B400

JJ 400A Frame 240V max., 3-pole with Thermal-Magnetic Non-Interchangeable Trip Unit^①

Continuous Ampere Rating	N-Interrupting Class
	Catalog Number
	COMPLETE BREAKER
250	NJJ3B250
300	NJJ3B300
350	NJJ3B350
400	NJJ3B400

^① Terminal connectors must be ordered separately.
Breaker Type NJJA.

VL Circuit Breakers

JG 400A Electronic Trip Units

Selection

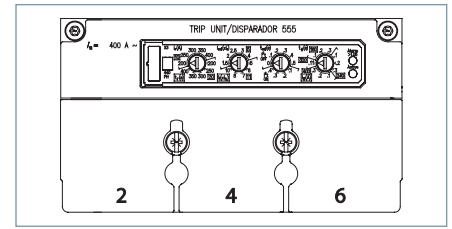
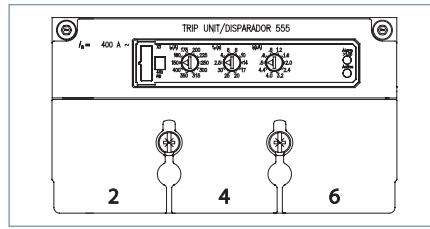

Model 555 Trip Units

JG 400A Frame 3-Pole Electronic Trip Unit

Continuous Ampere Rating	N-Interrupting Class	H-Interrupting Class	L-Interrupting Class	Catalog Number
	Catalog Number	Catalog Number	Catalog Number	
	FRAME ONLY			
	NJG3F400	HJG3F400	LJG3F400	
COMPLETE FACTORY ASSEMBLED CIRCUIT BREAKER				TRIP UNIT ONLY
ELECTRONIC LI TRIP				
250	NJG3R250L	HJG3R250L	LJG3R250L	CJT3R250
400	NJG3R400L	HJG3R400L	LJG3R400L	CJT3R400
ELECTRONIC LSI TRIP				
250	NJG3T250L	HJG3T250L	LJG3T250L	CJT3T250
400	NJG3T400L	HJG3T400L	LJG3T400L	CJT3T400
ELECTRONIC LSIG TRIP				
250	NJG3V250L	HJG3V250L	LJG3V250L	CJT3V250
400	NJG3V400L	HJG3V400L	LJG3V400L	CJT3V400
ELECTRONIC LIG TRIP				
250	NJG3W250L	HJG3W250L	LJG3W250L	CJT3W250
400	NJG3W400L	HJG3W400L	LJG3W400L	CJT3W400

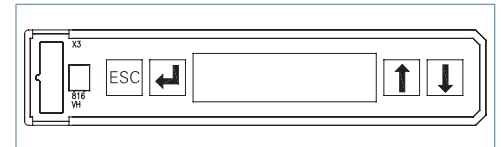

Model 586 Trip Unit

JG 400A Frame 3-Pole Electronic LCD Trip Unit

Continuous Ampere Rating	N-Interrupting Class	H-Interrupting Class	L-Interrupting Class	Catalog Number
	Catalog Number	Catalog Number	Catalog Number	
	FRAME ONLY			
	NJG3F400	HJG3F400	LJG3F400	
COMPLETE FACTORY ASSEMBLED CIRCUIT BREAKER				TRIP UNIT ONLY
LCD ELECTRONIC LSI TRIP				
250	NJG3A250L	HJG3A250L	LJG3A250L	CJT3A250
400	NJG3A400L	HJG3A400L	LJG3A400L	CJT3A400
LCD ELECTRONIC LSIG TRIP				
250	NJG3G250L	HJG3G250L	LJG3G250L	CJT3G250
400	NJG3G400L	HJG3G400L	LJG3G400L	CJT3G400
LCD ELECTRONIC LSI TRIP + GF ALARM ONLY				
250	NJG3K250L	HJG3K250L	LJG3K250L	CJT3K250
400	NJG3K400L	HJG3K400L	LJG3K400L	CJT3K400

7 MOLDED CASE CIRCUIT BREAKERS

VL Circuit Breakers

Internal Accessories for JG 400A and LG 600A Frames

Selection

Auxiliary Switch and Alarm Switch Combination Kits

Description	Mounting Pocket ^①	Catalog Number
1 Alarm Switch 1A/B ^③ Bases AMBL2 & AMBL3	Left, Right ^②	ASKL1
2 Aux. Switches 1A + 1B Bases AMBL1	Left, Right	ASKL2
2 Aux. + 1 Alarm Switches 1A + 1B, 1A/B Bases AMBL2 & AMBL3	Left, Right ^②	ASKL3

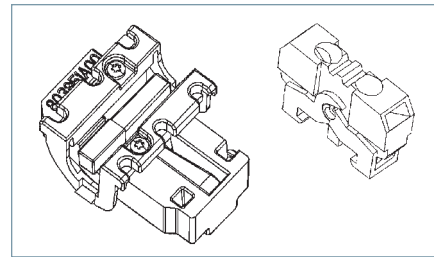

Auxiliary/Alarm Switch Mounting Base Only

Description	Mounting Pocket	Catalog Number
Up to 3 Auxiliary Switches	Left, Right	AMBL1
2 Aux. + 1 Alarm Switch	Left Pocket Only	AMBL2
2 Aux. + 1 Alarm Switch	Right Pocket Only	AMBL3

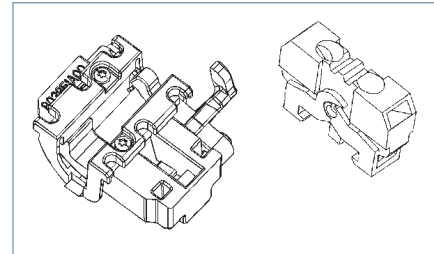

Auxiliary/Alarm Switch Only

Common to DG - PG Frames

Description	Catalog Number
1 Normally Open Contact (1A)	ASWPA
1 Normally Closed Contact (1B)	ASWPB

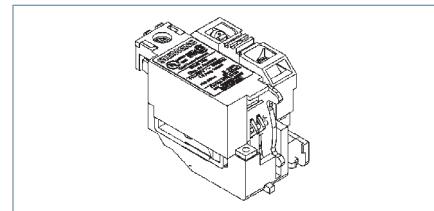

Shunt Trips

Description	Mounting Pocket	Catalog Number
24 VDC	Right Pocket Only	STRLB24DC
48-60 VDC		STRLC60DC
110-127 VDC		STRLD125DC
220-250 VDC		STRLE250DC
48-60 VAC		STRLM60
110-127 VAC		STRLN120
208-277 VAC		STRLS277
380-600 VAC		STRLV600



Undervoltage Release

Description	Mounting Pocket	Catalog Number
12 VDC	Right Pocket Only	UVRLA12DC
24 VDC		UVRLB24DC
48 VDC		UVRLC48DC
60 VDC		UVRLG60DC
110-127 VDC		UVRLD125DC
220-250 VDC		UVRLE250DC
24 VAC		UVRLL24
110-127 VAC		UVRN120
220-240 VAC		UVRRL240
208 VAC		UVRLP208
277 VAC		UVRLS277
380-415 VAC		UVRLT415
440-480 VAC		UVRLU480

① Refer to the "Accessory Locations" chart on page 7-152 for guidelines and limitations about which pockets may be used for accessory combinations.

② Includes 1A and 1B contact for alarm purposes, only one of which may be installed at any time.

'A' refers to a normally open contact (open when the breaker contacts are open).

'B' refers to a normally closed contact (closed when the breaker contacts are open).

External Accessories pages 7-137 through 7-151

VL Circuit Breakers

LG 600A Frame, VL Series

Selection/Dimensions

Ordering Information

Complete Assembled Breaker

A complete factory assembled LG breaker includes the frame, trip unit, and standard line and load lugs, all factory installed and shipped as a complete breaker. Assembled breakers are available only with standard connectors.

For DC applications, use thermal magnetic trip unit only.

Breakers are suitable for reverse feed applications.

For special applications, refer to page 7-156.

Mounting hardware is included with each breaker.

For 100% rated breakers, change the 3rd character of the catalog number to "W". Available on 400/500 Amp only (3-pole only).

HACR rated.



Interrupting Ratings

Interrupting Class	Breaker Type	RMS Symmetrical Amperes (KA)										
		UL 489					IEC 60947-2					
		Volts AC (50/60 Hz)			Volts DC		Volts AC (50/60 Hz)					
		240	480	600	250	500	220/240		380/415		690	
					I _{cu}	I _{cs}	I _{cu}	I _{cs}	I _{cu}	I _{cs}		
N	NLGB	65	35	18	30	25	65	65	45	45	12	6
H	HLGB	100	65	18 ^①	30	35	100	75	70	70	15	8
L	LLGB	200	100	18	30	35	200	150	100	75	15	8

① Special 600Vac 25kA thermal-magnetic version (Type HLGC) available, see page 7-120.

Connectors for 75°C Wire

Construction	Ampere Rating	Wire Range	No. of cables per connector	Catalog Number ^③
Aluminum	150-600	#2-600 kcmil Al/Cu	2 (load side)	3TA2LG600LD ^②
Aluminum	150-600	#2-600 kcmil Al/Cu	2 (line side)	3TA2LG600LN ^②
Copper	150-600	#2-600 kcmil Cu	2 (load side)	3TC2LG600LD ^⑤
Copper	150-600	#2-600 kcmil Cu	2 (line side)	3TC2LG600LN ^⑤
Compression Lugs				
	150-600	#6-350 kcmil Al/Cu	—	6CLL350 ^④
	150-600	250-750 kcmil Al/Cu	—	3CLL750 ^③
	150-600	250-600 kcmil Al/Cu	—	6CLL600 ^⑤

② Standard construction supplied for each breaker.

③ Kit consists of 3 terminal connectors.

④ Kit consists of 6 lugs for Line or Load end.

⑤ Required for 100% rated LG breakers. Requires 90°C Cu cable sized at 75°C ampacity.

LG Thermal-Magnetic, Instantaneous Trip Adjustment Range

Trip Unit Continuous Amp Rating (I _n)	Instantaneous Overcurrent Setting (I _t)	
	Min.	Max.
400	2000	4000
500	2500	5000
600	2750	5500

Note: Each breaker has 6 trip settings.

Dimensions, inches (mm)

Number of Poles	Width	Length	Depth	To Handle D1
2, 3	5.5 (139)	11 (279)	4.2 (102)	5.4 (138)
Ext. Shield		13.6 (345.5)		

Shipping Weight, lbs. (kg)

Poles	Frame	Trip Unit		Complete Breaker
		Thermal-Mag.	Electronic	
2, 3	17.4 (7.9)	3.5 (1.6)	4.2 (1.9)	20.9 (9.5)

7
MOLDED CASE
CIRCUIT BREAKERS

External Accessories pages 7-137 through 7-151

VL Circuit Breakers

LG 600A Thermal-Magnetic Trip Unit

Selection

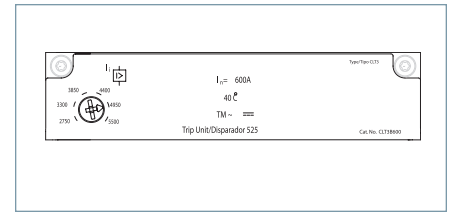

Model 525 Trip Unit

LG 600A Frame 2-Pole with Thermal-Magnetic Trip Unit

Continuous Ampere Rating	N-Interrupting Class	H-Interrupting Class	L-Interrupting Class
	Catalog Number	Catalog Number	Catalog Number
	COMPLETE FACTORY ASSEMBLED CIRCUIT BREAKER		
400	NLK2B400L	HLK2B400L	LLK2B400L
500	NLK2B500L	HLK2B500L	LLK2B500L
600	NLK2B600L	HLK2B600L	LLK2B600L

LG 600A Frame 3-Pole with Thermal-Magnetic Trip Unit^①

Continuous Ampere Rating	N-Interrupting Class	H-Interrupting Class	L-Interrupting Class
	Catalog Number	Catalog Number	Catalog Number
	COMPLETE FACTORY ASSEMBLED CIRCUIT BREAKER		
400	NLK3B400L	HLK3B400L	LLK3B400L
500	NLK3B500L	HLK3B500L	LLK3B500L
600	NLK3B600L	HLK3B600L	LLK3B600L

Type HLGC 600A Frame 2-Pole with Thermal-Magnetic Trip Unit , 600Vac 25kA only^②

Continuous Ampere Rating	N-Interrupting Class	H-Interrupting Class	L-Interrupting Class
	Catalog Number	Catalog Number	Catalog Number
	COMPLETE FACTORY ASSEMBLED CIRCUIT BREAKER		
400	—	HLV2B400L	—
500	—	HLV2B500L	—
600	—	HLV2B600L	—

Type HLGC 600A Frame 3-Pole with Thermal-Magnetic Trip Unit , 600Vac 25kA only^{①②}

Continuous Ampere Rating	N-Interrupting Class	H-Interrupting Class	L-Interrupting Class
	Catalog Number	Catalog Number	Catalog Number
	COMPLETE FACTORY ASSEMBLED CIRCUIT BREAKER		
400	—	HLV3B400L	—
500	—	HLV3B500L	—
600	—	HLV3B600L	—

① For 100% rated 400A or 500A versions, change the third character of the catalog number to "Z".

② Consult sales office for availability.

VL Circuit Breakers

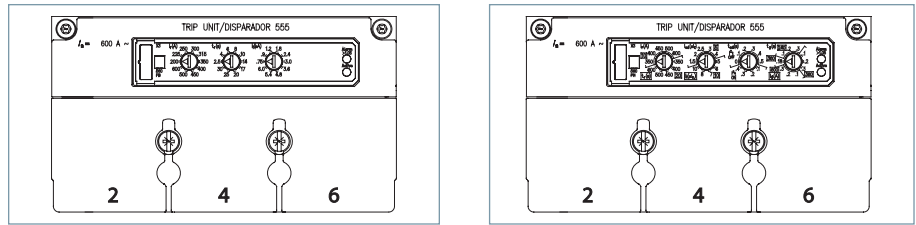

Model 555 Trip Unit

LG 600A Frame 3-Pole Electronic Trip Unit

Continuous Ampere Rating	N-Interrupting Class	H-Interrupting Class	L-Interrupting Class
	Catalog Number	Catalog Number	Catalog Number
COMPLETE FACTORY ASSEMBLED CIRCUIT BREAKER			
ELECTRONIC LI TRIP			
400	NLK3R400L	HLK3R400L	LLK3R400L
600	NLK3R600L	HLK3R600L	LLK3R600L
ELECTRONIC LSI TRIP			
400	NLK3T400L	HLK3T400L	LLK3T400L
600	NLK3T600L	HLK3T600L	LLK3T600L
ELECTRONIC LSIG TRIP			
400	NLK3V400L	HLK3V400L	LLK3V400L
600	NLK3V600L	HLK3V600L	LLK3V600L
ELECTRONIC LIG TRIP			
400	NLK3W400L	HLK3W400L	LLK3W400L
600	NLK3W600L	HLK3W600L	LLK3W600L

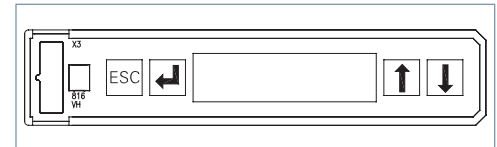

Model 586 Trip Unit

LG 600A Frame 3-Pole Electronic LCD Trip Unit

Continuous Ampere Rating	N-Interrupting Class	H-Interrupting Class	L-Interrupting Class
	Catalog Number	Catalog Number	Catalog Number
COMPLETE FACTORY ASSEMBLED CIRCUIT BREAKER			
ELECTRONIC LSI TRIP			
400	NLK3A400L	HLK3A400L	LLK3A400L
600	NLK3A600L	HLK3A600L	LLK3A600L
ELECTRONIC LSIG TRIP			
400	NLK3G400L	HLK3G400L	LLK3G400L
600	NLK3G600L	HLK3G600L	LLK3G600L
ELECTRONIC LSI TRIP + GF ALARM ONLY			
400	NLK3K400L	HLK3K400L	LLK3K400L
600	NLK3K600L	HLK3K600L	LLK3K600L

7
MOLDED CASE
CIRCUIT BREAKERS

VL Circuit Breakers

Internal Accessories for JG 400A and LG 600A Frames

Selection

Auxiliary Switch and Alarm Switch Combination Kits

Description	Mounting Pocket ^①	Catalog Number
1 Alarm Switch 1A/B ^③ Bases AMBL2 & AMBL3	Left, Right ^②	ASKL1
2 Aux. Switches 1A + 1B Bases AMBL1	Left, Right	ASKL2
2 Aux. + 1 Alarm Switches 1A + 1B, 1A/B Bases AMBL2 & AMBL3	Left, Right ^②	ASKL3

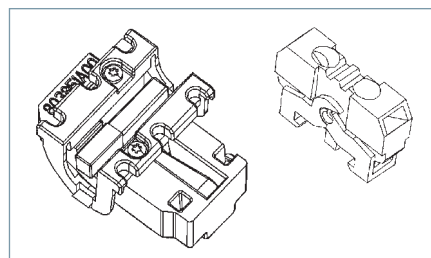

Auxiliary/Alarm Switch Mounting Base Only

Description	Mounting Pocket	Catalog Number
Up to 3 Auxiliary Switches	Left, Right	AMBL1
2 Aux. + 1 Alarm Switch	Left Pocket Only	AMBL2
2 Aux. + 1 Alarm Switch	Right Pocket Only	AMBL3

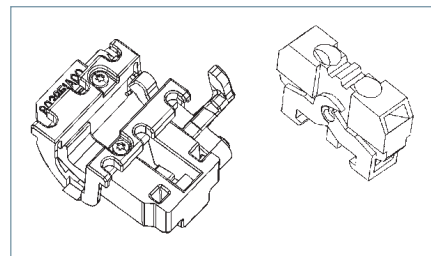

Auxiliary/Alarm Switch Only

Common to DG - PG Frames

Description	Catalog Number
1 Normally Open Contact (1A)	ASWPA
1 Normally Closed Contact (1B)	ASWPB

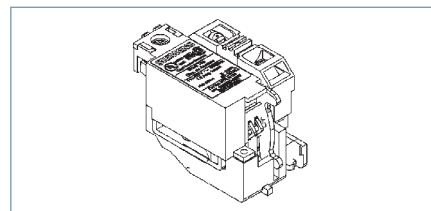

Shunt Trips

Description	Mounting Pocket	Catalog Number
24 VDC	Right Pocket Only	STRLB24DC
48-60 VDC		STRLC60DC
110-127 VDC		STRLD125DC
220-250 VDC		STRLE250DC
48-60 VAC		STRLM60
110-127 VAC		STRLN120
208-277 VAC		STRLS277
380-600 VAC		STRLV600



Undervoltage Release

Description	Mounting Pocket	Catalog Number
12 VDC	Right Pocket Only	UVRLA12DC
24 VDC		UVRLB24DC
48 VDC		UVRLC48DC
60 VDC		UVRLG60DC
110-127 VDC		UVRLD125DC
220-250 VDC		UVRLE250DC
24 VAC		UVRL24
110-127 VAC		UVRLN120
220-240 VAC		UVRLR240
208 VAC		UVRLP208
277 VAC		UVRLS277
380-415 VAC		UVRLT415
440-480 VAC		UVRLU480

① Refer to the "Accessory Locations" chart on page 7-152 for guidelines and limitations about which pockets may be used for accessory combinations.

② Includes 1A and 1B contact for alarm purposes, only one of which may be installed at any time. 'A' refers to a normally open contact (open when the breaker contacts are open).

'B' refers to a normally closed contact (closed when the breaker contacts are open).

External Accessories pages 7-137 through 7-151

VL Circuit Breakers

MG 800A Frame, VL Series

Selection/Dimensions

Ordering Information

Complete Assembled Breaker

A complete factory assembled MG breaker includes the frame, trip unit, and standard line and load lugs, all factory installed and shipped as a complete breaker. Assembled breakers are available only with standard connectors.

For any other configuration, order the frame, trip unit, and terminals as separate items.

For DC applications, use thermal magnetic trip unit only.

For reverse feed applications, select non-interchangeable trip breakers only. For non-interchangeable trip breakers, change the third digit of the catalog number to "X" for standard breakers.

For 100% rated breakers with a non-interchangeable trip unit, change the 3rd character of the catalog number to "Y".

For special applications, refer to page 7-156.

Mounting hardware is included with each frame or complete breaker.
HACR rated.



Dimensions, inches (mm)

Number of Poles	Width	Length	Depth	To Handle D1
2, 3	7.5 (190)	16 (406)	4.7 (119)	5.9 (151)

Shipping Weight, lbs. (kg)

Poles	Frame	Trip Unit	Complete Breaker
2, 3	31.3 (14.2)	4.0 (1.8)	35.3 (16.0)

Interrupting Ratings

Interrupting Class	Breaker Type	RMS Symmetrical Amperes (KA)										
		UL 489					IEC 60947-2					
		Volts AC (50/60 Hz)			Volts DC		Volts AC (50/60 Hz)					
		240	480	600	250	500	220/240		380/415		690	
					I _{cu}	I _{cs}	I _{cu}	I _{cs}	I _{cu}	I _{cs}		
N	NMG	65	35	25	22	35	65	65	50	50	20	10
H	HMG	100	65	35	25	50	100	75	70	70	30	15
L	LMG	200	100	50	42	65	200	150	100	75	35	17

Connectors for 75°C Wire

Construction	Ampere Rating	Wire Range	No. of cables per connector	Catalog Number
Aluminum	200-800A	1/0-500 kcmil Al/Cu	3	3TA3MG500 ^{①②}
Aluminum	200-800A	500-750 kcmil Al/Cu	2	3TA2MG750 ^②
Copper	200-800A	1/0-500 kcmil Cu	3	TC3MG500 ^{③⑤}
Aluminum	200-800A	#2-600 kcmil Al/Cu	3	3TA3MG600 ^{②④}

① Standard connector supplied with complete breakers.

② Kit consists of 3 terminal connectors.

③ Consists of one terminal.

④ Includes extended terminal cover.

⑤ Required for 100% rated MG breakers. Requires 90°C Cu cable sized at 75°C ampacity.

MG Thermal-Magnetic, Instantaneous Trip Adjustment Range

Trip Unit Continuous Amp Rating (I _n)	Instantaneous Overcurrent Setting (I _t)	
	Min.	Max.
600	3000	6000
700	3250	6500
800	3250	6500

Note: Each breaker has 6 trip settings.

7 MOLDED CASE CIRCUIT BREAKERS

External Accessories pages 7-137 through 7-151

VL Circuit Breakers

MG 800A Thermal-Magnetic Trip Unit

Selection

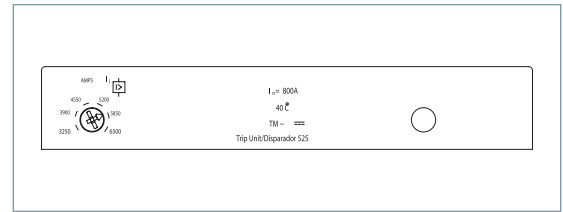

Model 525 Trip Unit

MG 800A Frame 2-Pole with Thermal-Magnetic Trip Unit

Continuous Ampere Rating	N-Interrupting Class	H-Interrupting Class	L-Interrupting Class	TRIP UNIT ONLY	
	Catalog Number	Catalog Number	Catalog Number		Catalog Number
	FRAME ONLY				
	NMG2F800	HMG2F800	LMG2F800		
	COMPLETE FACTORY ASSEMBLED CIRCUIT BREAKER				
600	NMG2B600L	HMG2B600L	LMG2B600L	CMT2B600	
700	NMG2B700L	HMG2B700L	LMG2B700L	CMT2B700	
800	NMG2B800L	HMG2B800L	LMG2B800L	CMT2B800	

MG 800A Frame 3-Pole with Thermal-Magnetic Trip Unit

Continuous Ampere Rating	N-Interrupting Class	H-Interrupting Class	L-Interrupting Class	TRIP UNIT ONLY	
	Catalog Number	Catalog Number	Catalog Number		Catalog Number
	FRAME ONLY				
	NMG3F800	HMG3F800	LMG3F800		
	COMPLETE FACTORY ASSEMBLED CIRCUIT BREAKER				
600	NMG3B600L	HMG3B600L	LMG3B600L	CMT3B600	
700	NMG3B700L	HMG3B700L	LMG3B700L	CMT3B700	
800	NMG3B800L	HMG3B800L	LMG3B800L	CMT3B800	

7

MOLDED CASE
CIRCUIT BREAKERS

VL Circuit Breakers

MG 800A Electronic Trip Units

Selection

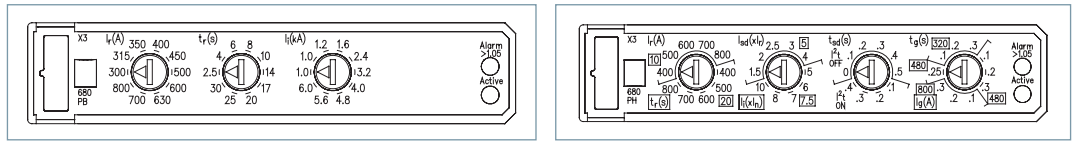

Model 555 Trip Units

MG 800A Frame 3-Pole Electronic Trip Unit

Continuous Ampere Rating	N-Interrupting Class	H-Interrupting Class	L-Interrupting Class	Catalog Number
	Catalog Number	Catalog Number	Catalog Number	
	FRAME ONLY			
	NMG3F800	HMG3F800	LMG3F800	
COMPLETE FACTORY ASSEMBLED CIRCUIT BREAKER				TRIP UNIT ONLY
ELECTRONIC LI TRIP				
600	NMG3R600L	HMG3R600L	LMG3R600L	CMT3R600
800	NMG3R800L	HMG3R800L	LMG3R800L	CMT3R800
ELECTRONIC LSI TRIP				
600	NMG3T600L	HMG3T600L	LMG3T600L	CMT3T600
800	NMG3T800L	HMG3T800L	LMG3T800L	CMT3T800
ELECTRONIC LSIG TRIP				
600	NMG3V600L	HMG3V600L	LMG3V600L	CMT3V600
800	NMG3V800L	HMG3V800L	LMG3V800L	CMT3V800
ELECTRONIC LIG TRIP				
600	NMG3W600L	HMG3W600L	LMG3W600L	CMT3W600
800	NMG3W800L	HMG3W800L	LMG3W800L	CMT3W800

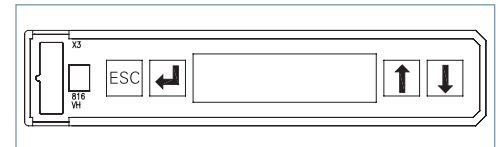

Model 586 Trip Unit

MG 800A Frame 3-Pole Electronic LCD Trip Unit

Continuous Ampere Rating	N-Interrupting Class	H-Interrupting Class	L-Interrupting Class	Catalog Number
	Catalog Number	Catalog Number	Catalog Number	
	FRAME ONLY			
	NMG3F800	HMG3F800	LMG3F800	
COMPLETE FACTORY ASSEMBLED CIRCUIT BREAKER				TRIP UNIT ONLY
LCD ELECTRONIC LSI TRIP				
600	NMG3A600L	HMG3A600L	LMG3A600L	CMT3A600
800	NMG3A800L	HMG3A800L	LMG3A800L	CMT3A800
LCD ELECTRONIC LSIG TRIP				
600	NMG3G600L	HMG3G600L	LMG3G600L	CMT3G600
800	NMG3G800L	HMG3G800L	LMG3G800L	CMT3G800
LCD ELECTRONIC LSI TRIP + GF ALARM ONLY				
600	NMG3K600L	HMG3K600L	LMG3K600L	CMT3K600
800	NMG3K800L	HMG3K800L	LMG3K800L	CMT3K800

7
MOLDED CASE
CIRCUIT BREAKERS

VL Circuit Breakers

Internal Accessories for MG 800A, NG 1200A and PG 1600A Frames

Selection

Auxiliary Switch and Alarm Switch Combination Kits

Description	Mounting Pocket ^①	Catalog Number
2 Aux. + 2 Alarm Switches 2A + 2B Bases AMBP2	Left Pocket Only	ASKP3
4 Aux. Switches 2A + 2B Bases AMBP1	Left, Right	ASKP4

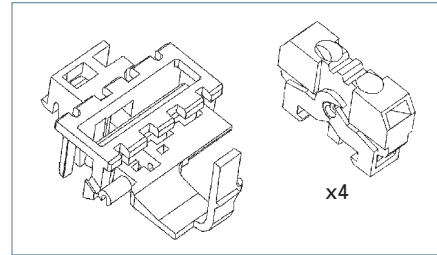

Auxiliary/Alarm Switch Mounting Base Only

Description	Mounting Pocket	Catalog Number
Up to 4 Auxiliary Switches	Left, Right	AMBP1
2 Aux. + 2 Alarm Switches	Left Pocket Only	AMBP2

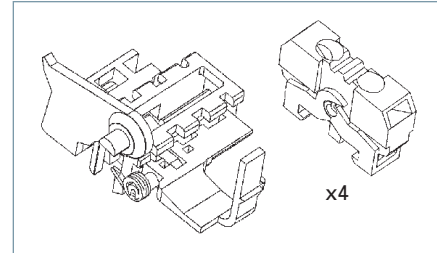

Auxiliary/Alarm Switch Only

Common to DG - PG Frames

Description	Catalog Number
1 Normally Open Contact (1A)	ASWPA
1 Normally Closed Contact (1B)	ASWPB

Shunt Trips

Description	Mounting Pocket	Catalog Number
24 VDC	Right Pocket Only	STRPB24DC
48-60 VDC		STRPC60DC
110-127 VDC		STRPD125DC
220-250 VDC		STRPE250DC
48-60 VAC		STRPM60
110-127 VAC		STRPN120
208-277 VAC		STRPS277
380-600 VAC		STRPV600



Undervoltage Release

Description	Mounting Pocket	Catalog Number
12 VDC	Right Pocket Only	UVRPA12DC
24 VDC		UVRPB24DC
48 VDC		UVRPC48DC
60 VDC		UVRPG60DC
110-127 VDC		UVRPD125DC
220-250 VDC		UVRPE250DC
110-127 VAC		UVRPN120
220-240 VAC		UVRPR240
208 VAC		UVRPP208
277 VAC		UVRPS277
380-415 VAC		UVRPT415
440-480 VAC		UVRPU480

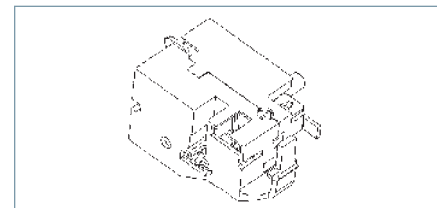

^① Refer to the "Accessory Locations" chart on page 7-152 for guidelines and limitations about which pockets may be used for accessory combinations.

'A' refers to a normally open contact (open when the breaker contacts are open).

'B' refers to a normally closed contact (closed when the breaker contacts are open).

VL Circuit Breakers

NG 1200A Frame, VL Series

Selection/Dimensions

Ordering Information

Complete Assembled Breaker with Lugs

A complete factory assembled NG breaker includes the frame, trip unit, and standard line and load lugs, all factory installed and shipped as a complete breaker. Assembled breakers are available only with standard connectors.

For any other configuration, order the frame, trip unit, and terminals as separate items.

For DC applications, use thermal magnetic trip unit only.

For reverse feed applications, select non-interchangeable trip breakers only. For non-interchangeable trip breakers, change the third digit of the catalog number to "X" for standard breakers.

For 100% rated breakers with a non-interchangeable trip unit, change the 3rd character of the catalog number to "Y".

For special applications, refer to page 7-156.

Mounting hardware is included with each frame or complete breaker.

A Toggle Handle Extension is included with each frame or complete breaker.

HACR rated.



Dimensions, inches (mm)

Number of Poles	W	L	D	To Handle D1
2, 3	9 (229)	16 (406)	6 (152)	8.1 (207)

Shipping Weight, lbs. (kg)

Poles	Frame	Trip Unit	Complete Breaker
2, 3	46.3 (21.0)	8.8 (4.0)	55.1 (25.0)

Interrupting Ratings

Interrupting Class	Breaker Type	RMS Symmetrical Amperes (KA)										
		UL 489					IEC 60947-2					
		Volts AC (50/60 Hz)			Volts DC		Volts AC (50/60 Hz)					
		240	480	600	250	500	220/240		380/415		690	
					I _{cu}	I _{cs}	I _{cu}	I _{cs}	I _{cu}	I _{cs}		
N	NNG	65	35	25	22	35	65	35	50	25	20	10
H	HNG	100	65	35	25	50	100	50	70	35	30	15
L	LNG	200	100	65	42	65	200	100	100	50	35	17

Connectors for 75°C Wire

Construction	Ampere Rating	Wire Range	No. of cables per connector	Catalog Number
Aluminum	300-1200A	1/0-500 kcmil Al/Cu	4	3TA4NG500 ^{③④}
Aluminum	300-1200A	500-750 kcmil Al/Cu	3	3TA3NG750 ^④
Copper	300-1200A	1/0-500 kcmil Cu	4	3TC4NG500 ^{②④}
Aluminum	300-1200A	1/0-500 kcmil Al/Cu	4	3TA4NG500H ^{②④}
Compression Lugs				
	300-1200A	1/0-500 kcmil Al/Cu	—	12CLN500 ^①

① Total of 12 connectors (4 per phase Line or Load).

② For 100% rated NG breakers. Requires 90°C Cu cable sized at 75°C ampacity.

③ Standard connector provided with complete breakers.

④ Kit consists of 3 terminal connectors.

NG Thermal-Magnetic, Instantaneous Trip Adjustment Range

Trip Unit Continuous Amp Rating (I _n)	Instantaneous Overcurrent Setting (I _b)	
	Min.	Max.
800	4000	8000
900	5000	10000
1000	5000	10000
1200	7000	12000

Note: Each breaker has 6 trip settings.

7 MOLDED CASE CIRCUIT BREAKERS

External Accessories pages 7-137 through 7-151

VL Circuit Breakers

NG 1200A Thermal-Magnetic Trip Unit

Selection

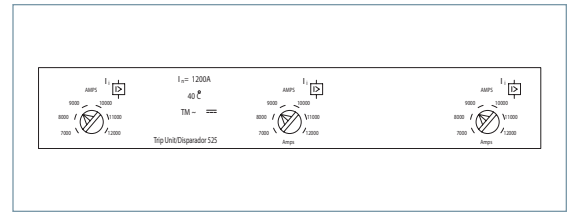

Model 525 Trip Unit

NG 1200A Frame 2-Pole with Thermal-Magnetic Trip Unit

Continuous Ampere Rating	N-Interrupting Class	H-Interrupting Class	L-Interrupting Class	
	Catalog Number	Catalog Number	Catalog Number	Catalog Number
	FRAME ONLY			TRIP UNIT ONLY
	NNG2F120	HNG2F120	LNG2F120	
	COMPLETE FACTORY ASSEMBLED CIRCUIT BREAKER			
800	NNG2B800L	HNG2B800L	LNG2B800L	CNT2B800
900	NNG2B900L	HNG2B900L	LNG2B900L	CNT2B900
1000	NNG2B100L	HNG2B100L	LNG2B100L	CNT2B100
1200	NNG2B120L	HNG2B120L	LNG2B120L	CNT2B120

NG 1200A Frame 3-Pole with Thermal-Magnetic Trip Unit

Continuous Ampere Rating	N-Interrupting Class	H-Interrupting Class	L-Interrupting Class	
	Catalog Number	Catalog Number	Catalog Number	Catalog Number
	FRAME ONLY			TRIP UNIT ONLY
	NNG3F120	HNG3F120	LNG3F120	
	COMPLETE FACTORY ASSEMBLED CIRCUIT BREAKER			
800	NNG3B800L	HNG3B800L	LNG3B800L	CNT3B800
900	NNG3B900L	HNG3B900L	LNG3B900L	CNT3B900
1000	NNG3B100L	HNG3B100L	LNG3B100L	CNT3B100
1200	NNG3B120L	HNG3B120L	LNG3B120L	CNT3B120

VL Circuit Breakers

NG 1200A Electronic Trip Units

Selection

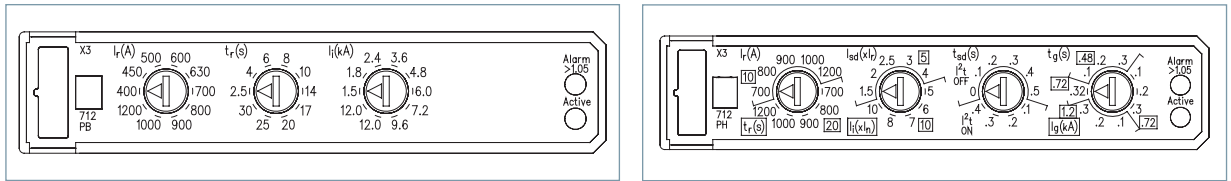

Model 555 Trip Units

NG 1200A Frame 3-Pole Electronic Trip Unit

Continuous Ampere Rating	N-Interrupting Class	H-Interrupting Class	L-Interrupting Class	Catalog Number
	Catalog Number	Catalog Number	Catalog Number	
	FRAME ONLY			
	NNG3F120	HNG3F120	LNG3F120	
COMPLETE FACTORY ASSEMBLED CIRCUIT BREAKER				TRIP UNIT ONLY
ELECTRONIC LI TRIP				
800	NNG3R800L	HNG3R800L	LNG3R800L	CNT3R800
1000	NNG3R100L	HNG3R100L	LNG3R100L	CNT3R100
1200	NNG3R120L	HNG3R120L	LNG3R120L	CNT3R120
ELECTRONIC LSI TRIP				
800	NNG3T800L	HNG3T800L	LNG3T800L	CNT3T800
1000	NNG3T100L	HNG3T100L	LNG3T100L	CNT3T100
1200	NNG3T120L	HNG3T120L	LNG3T120L	CNT3T120
ELECTRONIC LSIG TRIP				
800	NNG3V800L	HNG3V800L	LNG3V800L	CNT3V800
1000	NNG3V100L	HNG3V100L	LNG3V100L	CNT3V100
1200	NNG3V120L	HNG3V120L	LNG3V120L	CNT3V120
ELECTRONIC LIG TRIP				
800	NNG3W800L	HNG3W800L	LNG3W800L	CNT3W800
1000	NNG3W100L	HNG3W100L	LNG3W100L	CNT3W100
1200	NNG3W120L	HNG3W120L	LNG3W120L	CNT3W120

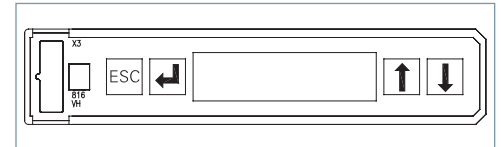

Model 586 Trip Unit

NG 1200A Frame 3-Pole Electronic LCD Trip Unit

Continuous Ampere Rating	N-Interrupting Class	H-Interrupting Class	L-Interrupting Class	Catalog Number
	Catalog Number	Catalog Number	Catalog Number	
	FRAME ONLY			
	NNG3F120	HNG3F120	LNG3F120	
COMPLETE FACTORY ASSEMBLED CIRCUIT BREAKER				TRIP UNIT ONLY
LCD ELECTRONIC LSI TRIP				
800	NNG3A800L	HNG3A800L	LNG3A800L	CNT3A800
1000	NNG3A100L	HNG3A100L	LNG3A100L	CNT3A100
1200	NNG3A120L	HNG3A120L	LNG3A120L	CNT3A120
LCD ELECTRONIC LSIG TRIP				
800	NNG3G800L	HNG3G800L	LNG3G800L	CNT3G800
1000	NNG3G100L	HNG3G100L	LNG3G100L	CNT3G100
1200	NNG3G120L	HNG3G120L	LNG3G120L	CNT3G120
LCD ELECTRONIC LSI TRIP + GF ALARM ONLY				
800	NNG3K800L	HNG3K800L	LNG3K800L	CNT3K800
1000	NNG3K100L	HNG3K100L	LNG3K100L	CNT3K100
1200	NNG3K120L	HNG3K120L	LNG3K120L	CNT3K120

7 MOLDED CASE CIRCUIT BREAKERS

VL Circuit Breakers

Internal Accessories for MG 800A, NG 1200A, and PG 1600A Frames

Selection

Auxiliary Switch and Alarm Switch Combination Kits

Description	Mounting Pocket ^①	Catalog Number
2 Aux. + 2 Alarm Switches 2A + 2B Base AMBP2	Left Pocket Only	ASKP3
4 Aux. Switches 2A + 2B Base AMBP1	Left, Right	ASKP4

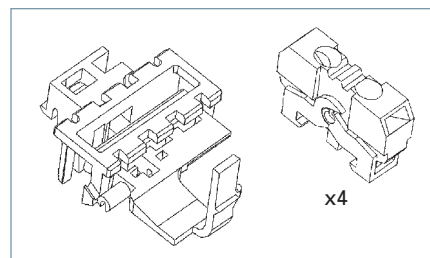

Auxiliary/Alarm Switch Mounting Base Only

Description	Mounting Pocket ^①	Catalog Number
Up to 4 Auxiliary Switches 2 Aux. + 2 Alarm Switches	Left, Right Left Pocket Only	AMBP1 AMBP2

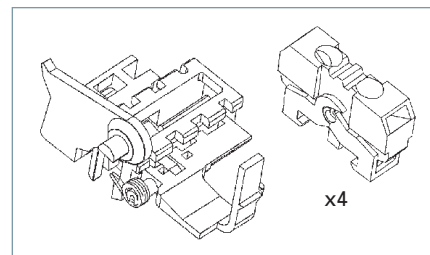

Auxiliary/Alarm Switch Only

Common to DG-PG Frames

Description	Catalog Number
1 Normally Open Contact (1A)	ASWPA
1 Normally Closed Contact (1B)	ASWPB

Shunt Trips

Description	Mounting Pocket	Catalog Number
24 VDC	Right Pocket Only	STRPB24DC
48-60 VDC		STRPC60DC
110-127 VDC		STRPD125DC
220-250 VDC		STRPE250DC
48-60 VAC		STRPM60
110-127 VAC		STRPN120
208-277 VAC		STRPS277
380-600 VAC		STRPV600



Undervoltage Release

Description	Mounting Pocket	Catalog Number
12 VDC	Right Pocket Only	UVRPA12DC
24 VDC		UVRPB24DC
48 VDC		UVRPC48DC
60 VDC		UVRPG60DC
110-127 VDC		UVRPD125DC
220-250 VDC		UVRPE250DC
110-127 VAC		UVRPN120
220-240 VAC		UVRPR240
208 VAC		UVRPP208
277 VAC		UVRPS277
380-415 VAC		UVRPT415
440-480 VAC		UVRPU480

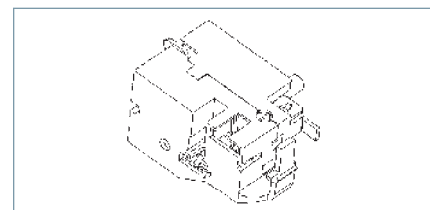

① Refer to the "Accessory Locations" chart on page 7-152 for guidelines and limitations about which pockets may be used for accessory combinations.
'A' refers to a normally open contact (open when the breaker contacts are open).
'B' refers to a normally closed contact (closed when the breaker contacts are open).

VL Circuit Breakers

PG 1600A Frame, VL Series & Thermal-Magnetic Trip Unit

Selection/Dimensions

Ordering Information

A complete factory assembled PG breaker includes the frame and trip unit only. The connectors must be ordered as separate items.

PG thermal-magnetic breakers sold as non-interchangeable only.

For any other configuration, order the frame, trip unit, and connectors as separate items.

Connectors require a Breaker Lug Mounting Assembly or Breaker Mounting Base and must be ordered as a separate item.

For DC applications, use Thermal magnetic trip unit only.

For reverse feed applications select non-interchangeable trip breakers only. Change the third digit of the catalog number to "X" for non-interchangeable trip breakers.

For 100% rated breakers with a non-interchangeable trip unit, change the 3rd character of the catalog number to "Y".

For special applications, refer to page 7-156.

Mounting hardware is included with each frame or complete breaker.

A Toggle Handle Extension is included with each frame or complete breaker.



Dimensions, inches (mm)

Number of Poles	W	L	D	To Handle D1
2, 3	9 (229)	16 (406)	6 (152)	8.1 (207)

Shipping Weight, lbs. (kg)

Poles	Frame	Trip Unit	Complete Breaker
2, 3	60.2 (27.3)	8.8 (4.0)	69.0 (31.3)

PG Thermal-Magnetic, Instantaneous Trip Adjustment Range

Trip Unit Continuous Amp Rating (I _n)	Instantaneous Overcurrent Setting (I _t)	
	Min.	Max.
1200	7000	12000
1400	7000	12000
1600	7000	12000

Note: Each breaker has 6 trip settings in this range.

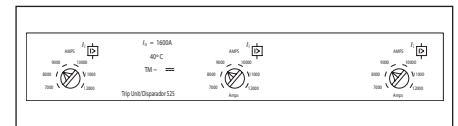

Model 525 Trip Unit

Interrupting Ratings

Interrupting Class	Breaker Type	RMS Symmetrical Amperes (KA)										
		UL 489					IEC 60947-2 [®] (ETU only)					
		Volts AC (50/60 Hz)			Volts DC		Volts AC (50/60 Hz)					
		240	480	600	250	500	220/240		380/415		690	
					I _{cu}	I _{cs}	I _{cu}	I _{cs}	I _{cu}	I _{cs}		
N	NPG	65	35	25	22	35	65	35	50	25	20	10
H	HPG	100	65	35	25	50	100	50	70	35	30	15
L	LPG	200	100	65	42	65	200	100	100	50	35	17

Connectors for 75°C Wire

Construction	Ampere Rating	Wire Range	No. of cables per phase	Catalog Number
Aluminum	1200-1600A	1/0-750 kcmil Al/Cu	6	3TA6PG750 ^{①③}
Aluminum	1200-1600A	300-600 kcmil Al/Cu	5	TA5P600 ^{②④}
Aluminum	1200-1600A	600-750 kcmil Al/Cu	4	TA4P750 ^{②④}
Aluminum	1200-1600A	300-600 kcmil Al/Cu	6	TA6R600 ^{②④}
Copper	1200-1600A	300-600 kcmil Cu	5	TC5R600 ^{②④⑤}

Mounting Arrangement

Description	Catalog Number
Lug Mounting Assembly	LMAP1600
Breaker Mounting Base (Front Connect)	MBPG1600
Breaker Mounting Base (Rear Connect)	MBPG1601

PG 1600A Frame 3-Pole with Thermal-Magnetic Trip Unit[®]

Continuous Ampere Rating	N-Interrupting Class	H-Interrupting Class	L-Interrupting Class
	Catalog Number	Catalog Number	Catalog Number
	COMPLETE FACTORY ASSEMBLED CIRCUIT BREAKER		
1200	NPX3B120	HPX3B120	LPX3B120
1400	NPX3B140	HPX3B140	LPX3B140
1600	NPX3B160	HPX3B160	LPX3B160

① Requires Lug Mounting Assembly LMAP1600.
 ② Requires Breaker Mounting Base MBPG1600 Kit or MBPG1601.
 ③ Consists of 3 connectors.

④ Consists of 1 connector.
 ⑤ Required for 100% rated PG breakers. Requires 90°C cable sized at 75°C ampacity.
 ⑥ IEC 60947-2: ONLY applies to Electronic Trip Units (ETUs).

External Accessories pages 7-137 through 7-151

VL Circuit Breakers

PG 1600A Electronic Trip Units

Selection

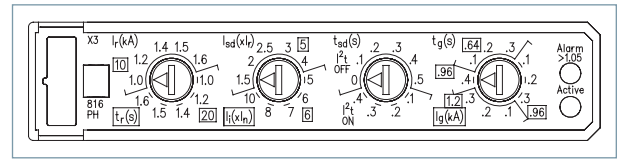
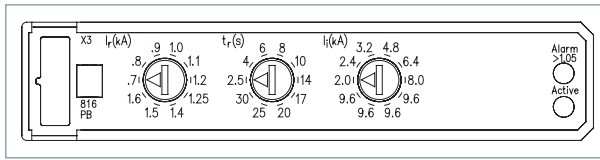

Model 555 Trip Unit

PG 1600A Frame 3-Pole Electronic Trip Unit

Continuous Ampere Rating	N-Interrupting Class	H-Interrupting Class	L-Interrupting Class	Catalog Number
	Catalog Number	Catalog Number	Catalog Number	
	FRAME ONLY			
	NPG3F160	HPG3F160	LPG3F160	
COMPLETE FACTORY ASSEMBLED CIRCUIT BREAKER				TRIP UNIT ONLY
ELECTRONIC LI TRIP				
1200	NPG3R120	HPG3R120	LPG3R120	CPT3R120
1600	NPG3R160	HPG3R160	LPG3R160	CPT3R160
ELECTRONIC LSI TRIP				
1200	NPG3T120	HPG3T120	LPG3T120	CPT3T120
1600	NPG3T160	HPG3T160	LPG3T160	CPT3T160
ELECTRONIC LSIG TRIP				
1200	NPG3V120	HPG3V120	LPG3V120	CPT3V120
1600	NPG3V160	HPG3V160	LPG3V160	CPT3V160
ELECTRONIC LIG TRIP				
1200	NPG3W120	HPG3W120	LPG3W120	CPT3W120
1600	NPG3W160	HPG3W160	LPG3W160	CPT3W160

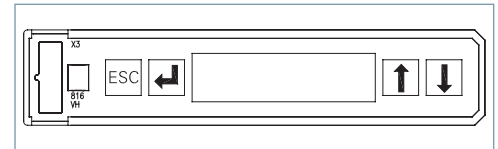

Model 586 Trip Unit

PG 1600A Frame 3-Pole Electronic LCD Trip Unit

Continuous Ampere Rating	N-Interrupting Class	H-Interrupting Class	L-Interrupting Class	Catalog Number
	Catalog Number	Catalog Number	Catalog Number	
	FRAME ONLY			
	NPG3F160	HPG3F160	LPG3F160	
COMPLETE FACTORY ASSEMBLED CIRCUIT BREAKER				TRIP UNIT ONLY
LCD ELECTRONIC LSI TRIP				
1200	NPG3A120	HPG3A120	LPG3A120	CPT3A120
1600	NPG3A160	HPG3A160	LPG3A160	CPT3A160
LCD ELECTRONIC LSIG TRIP				
1200	NPG3G120	HPG3G120	LPG3G120	CPT3G120
1600	NPG3G160	HPG3G160	LPG3G160	CPT3G160
LCD ELECTRONIC LSI TRIP + GF ALARM ONLY				
1200	NPG3K120	HPG3K120	LPG3K120	CPT3K120
1600	NPG3K160	HPG3K160	LPG3K160	CPT3K160

VL Circuit Breakers

Internal Accessories for MG 800A, NG 1200A, and PG 1600A Frames

Selection

Auxiliary Switch and Alarm Switch Combination Kits

Description	Mounting Pocket ^①	Catalog Number
2 Aux. + 2 Alarm Switches 2A + 2B Base AMBP2	Left Pocket Only	ASKP3
4 Aux. Switches 2A + 2B Base AMBP1	Left, Right	ASKP4

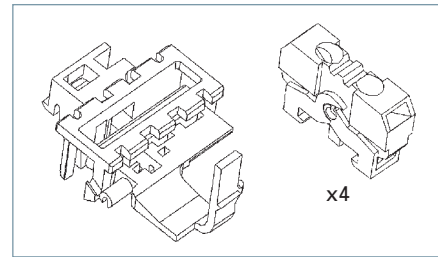

Auxiliary/Alarm Switch Mounting Base Only

Description	Mounting Pocket ^①	Catalog Number
Up to 4 Auxiliary Switches 2 Aux. + 2 Alarm Switches	Left, Right Left Pocket Only	AMBP1 AMBP2

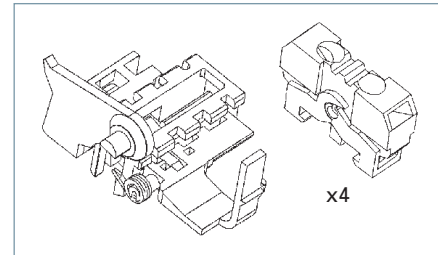

Auxiliary/Alarm Switch Only

Common to DG-PG Frames

Description	Catalog Number
1 Normally Open Contact (1A)	ASWPA
1 Normally Closed Contact (1B)	ASWPB

Shunt Trips

Description	Mounting Pocket	Catalog Number
24 VDC	Right Pocket Only	STRPB24DC
48-60 VDC		STRPC60DC
110-127 VDC		STRPD125DC
220-250 VDC		STRPE250DC
48-60 VAC		STRPM60
110-127 VAC		STRPN120
208-277 VAC		STRPS277
380-600 VAC		STRPV600



Undervoltage Release

Description	Mounting Pocket	Catalog Number
12 VDC	Right Pocket Only	UVRPA12DC
24 VDC		UVRPB24DC
48 VDC		UVRPC48DC
60 VDC		UVRPG60DC
110-127 VDC		UVRPD125DC
220-250 VDC		UVRPE250DC
110-127 VAC		UVRPN120
220-240 VAC		UVRPR240
208 VAC		UVRPP208
277 VAC		UVRPS277
380-415 VAC		UVRPT415
440-480 VAC		UVRPU480

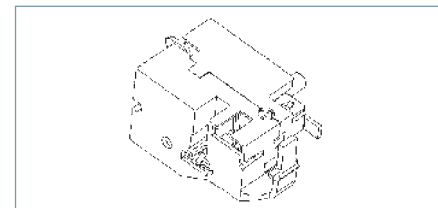

① Refer to the "Accessory Locations" chart on page 7-152 for guidelines and limitations about which pockets may be used for accessory combinations.

'A' refers to a normally open contact (open when the breaker contacts are open).

'B' refers to a normally closed contact (closed when the breaker contacts are open).

VL Circuit Breakers

Molded Case Switch

Selection

General

Typically a molded case switch is used when a compact load-break switch is needed for disconnect purposes. The VL line of molded case switches from Siemens is made of the same materials and components as the VL circuit breakers but do not provide overcurrent protection. Each molded case

switch has a fixed instantaneous self-protecting trip element which may open the switch under high fault conditions.

Application Note

Overcurrent protection must be provided by an appropriate overcurrent protective device located upstream from

the molded case switch. Also, the short-circuit current rating of the switch is limited to the interrupting rating of the upstream protective device or the ratings in the table below, **whichever is less.**

Ordering Information

Each type VL molded case switch accepts the same terminals and accessories as the equivalent VL circuit breakers.

All type VL molded case switches are suitable for reverse feed applications.

Mounting hardware and standard line and load terminals are included on ratings through 250A. For 400 – 1600A ratings, order the lugs separately.

All ratings are UL listed and CSA certified.

Molded Case Switch

Maximum Ampere Rating / Frame	2-Pole	3-Pole	Short-Circuit Current Rating ^①			Self Protective Instantaneous Override
	Catalog Number	Catalog Number	240V	480V	600V	
150A / DG	HDR2S150	HDR3S150	100k	65k	20k	2,500A
250A / FG	HFR2S250	HFR3S250	100k	65k	20k	3,500A
400A / JG	HJS2S400	HJS3S400	100k	65k	25k	4,400A
600A / LG	HLR2S600	HLR3S600	100k	65k	18k	5,500A
800A / MG	HMS2S800	HMS3S800	100k	65k	35k	6,500A
1200A / NG	HNS2S120	HNS3S120	100k	65k	35k	12,000A
1600A / PG	—	HPS3S160	100k	65k	35k	14,000A

Maximum Ampere Rating / Frame	3-Pole	Short-Circuit Current Rating ^①			Self Protective Instantaneous Override
	Catalog Number	240V	480V	600V	
250A / FG	LFR3S250	200k	100k	25k	3,500A
400A / JG	LJS3S400	200k	100k	25k	4,400A
600A / LG	LLR3S600	200k	100k	18k	5,500A
800A / MG	LMS3S800	200k	100k	65k	6,500A
1200A / NG	LNS3S120	200k	100k	65k	12,000A
1600A / PG	LPS3S160	200k	100k	65k	14,000A

^①The Short-Circuit Current Rating is the maximum available current of the circuit where the switch is used, when protected by an appropriate overcurrent protective device.

VL Circuit Breakers

General

Protection of Motor Circuits

Molded case circuit breakers are used in motor circuits as a disconnecting means and for short-circuit protection. They should be used in conjunction with motor-running, over-current protection devices, and should permit the motor to start without nuisance tripping from motor-inrush current. The circuit breaker should have a continuous current rating of not less than 115% of the motor full-load current.

The recommended motor circuit protectors listed have continuous-current ratings of at least 115% of motor full-load currents. The trip setting positions are approximately 11 times motor full-load current. The suggested trip settings may need to be adjusted upward to no higher than 1300% of full-load current for non-design E type motors, and no greater than 1700% of full-load current for design E motors, to allow for motor startup due to in-rush current.

Breaker Mounted Immediately Ahead of Motor Starter

Siemens motor circuit protectors are recommended for use in combination motor starters to provide selective short-circuit protection for the motor branch circuit. The adjustable instantaneous trip feature of the Siemens motor circuit protector provides for a trip setting slightly above the peak motor in-rush current. With this setting, no delay is introduced in opening the circuit when a fault occurs. This circuit breaker has no time-delay trip element. Therefore it must be used in conjunction with, and immediately ahead of, the motor-running overcurrent protection device.

Important: The information below does not apply to all motor applications: it is recommended that the user refer to the National Electrical Code (NEC) for specific needs.

Table 1 (When Breaker is Mounted Immediately Ahead of Motor Starter)

3-Phase Induction Type Motors (Siemens motor circuit protectors for branch circuit use with alternating-current combination, full voltage motor starters)

Motor Full Load Amperes	Trip Setting (A)	Catalog Number ^①
35-50	450	HDP3L150L
42-60	540	
48-70	630	
55-80	720	
62-90	810	
69-100	900	
58-83	750	HDP3M150L
69-100	900	
81-117	1050	
92-133	1200	
104-150	1350	
115-150 ^②	1500	
96-139	1250	HDP3H150L
115-150 ^②	1500	
135-150 ^②	1750	
135-150 ^②	2000	
135-150 ^②	2250	
135-150 ^②	2500	
46-67	600	HFP3L250L
55-80	720	
65-93	840	
74-107	960	
83-120	1080	
92-133	1200	
77-111	1000	HFP3M250L
92-133	1200	
108-156	1400	
123-178	1600	
138-200	1800	
154-222	2000	
135-194	1750	HFP3H250L
162-210	2100	
188-220	2450	
215-241	2800	
242-250 ^②	3150	
242-250 ^②	3500	

^① Motor circuit protectors rated 150A and 250A are supplied with line and load lugs installed. If lugs are required on 400A to 1200A motor circuit breakers, order required lugs separately.

Motor Full Load Amperes	Trip Setting (A)	Catalog Number ^①
96-139	1250	HJM3L400
115-167	1500	
135-194	1750	
154-222	2000	
173-250	2250	
192-278	2500	
154-222	2000	HJM3M400
185-267	2400	
215-311	2800	
246-356	3200	
277-400	3600	
308-400 ^②	4000	
154-222	2000	HLM3J600
185-267	2400	
215-311	2800	
246-356	3200	
277-400	3600	
308-444	4000	
212-306	2750	HLM3Y600
254-367	3300	
296-428	3850	
338-489	4400	
381-550	4950	
423-600	5500	
250-361	3250	HMM3M800
292-422	3800	
335-483	4350	
385-556	5000	
442-638	5740	
500-722	6500	
385-556	5000	HNM3M120
462-667	6000	
538-778	7000	
615-889	8000	
692-1000	9000	
769-1111	10,000	

^② These settings are provided for starting currents greater than 11X but not to exceed 17X. Full Load Amps (FLA) not to exceed ampere rating of MCP.

7
MOLDED CASE
CIRCUIT BREAKERS

VL Circuit Breakers

600 Volt DC Circuit Breakers

Selection

General

Siemens UL Listed non-interchangeable trip DC Thermal/magnetic Molded Case Circuit Breakers shown below are for use in grounded & ungrounded general DC circuits and ungrounded battery supply circuits of UPS systems. These breakers are rated at 600Vdc closed circuit and feature rated interruption levels from 42,000 to 65,000 amperes as indicated in

the table. This family of circuit breakers is rated from 50 to 1600 Amperes.

Types HDGD through HPGD circuit breakers are provided with an adjustable magnetic over-current function located on the face of the circuit breaker. Contact Siemens for specific magnetic over-current values.

To properly use these UL Listed circuit breakers at 600Vdc and the indicated

interruption level, it is necessary to connect the terminals of the 3 pole circuit breaker in a series configuration as shown in the diagram below.

Types HDGD through HPGD use the same internal and external accessories as the standard DG through PG frames and associated types. Consult the individual frame section for accessory information.

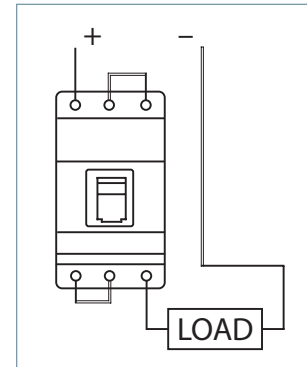

Frame	Type	Continuous Ampere Rating	Catalog Number (3-pole) ^①	Short-Circuit Current Rating 600VDC ^②
DG	HDGD	50	HDC3B050	42K
		60	HDC3B060	42K
		70	HDC3B070	42K
		80	HDC3B080	42K
		90	HDC3B090	42K
		100	HDC3B100	42K
		110	HDC3B110	42K
		125	HDC3B125	42K
		150	HDC3B150	42K
FG	HFGD	100	HFC3B100	42K
		150	HFC3B150	42K
		175	HFC3B175	42K
		200	HFC3B200	42K
		250	HFC3B250	42K
JG	HJGD	250	HJC3B250	65K
		300	HJC3B300	65K
		350	HJC3B350	65K
		400	HJC3B400	65K
LG	HLGD	400	HLC3B400	65K
		500	HLC3B500	65K
		600	HLC3B600	65K
MG	HMGD	600	HMC3B600	65K
		700	HMC3B700	65K
		800	HMC3B800	65K
NG	HNGD	800	HNC3B800	65K
		900	HNC3B900	65K
		1000	HNC3B1000	65K
		1200	HNC3B1200	65K
PG	HPGD	1200	HPC3B1200	65K
		1400	HPC3B1400	65K
		1600	HPC3B1600	65K

① Terminal connectors must be ordered separately; see page 7-146.

② Standard VL breakers DG - PG feature DC ratings up to 500V for ungrounded UPS applications. Consult the individual frame section for more information.

Modularity To Support All Your Application Needs Modules and More: VL Circuit Breakers with Optional Accessories

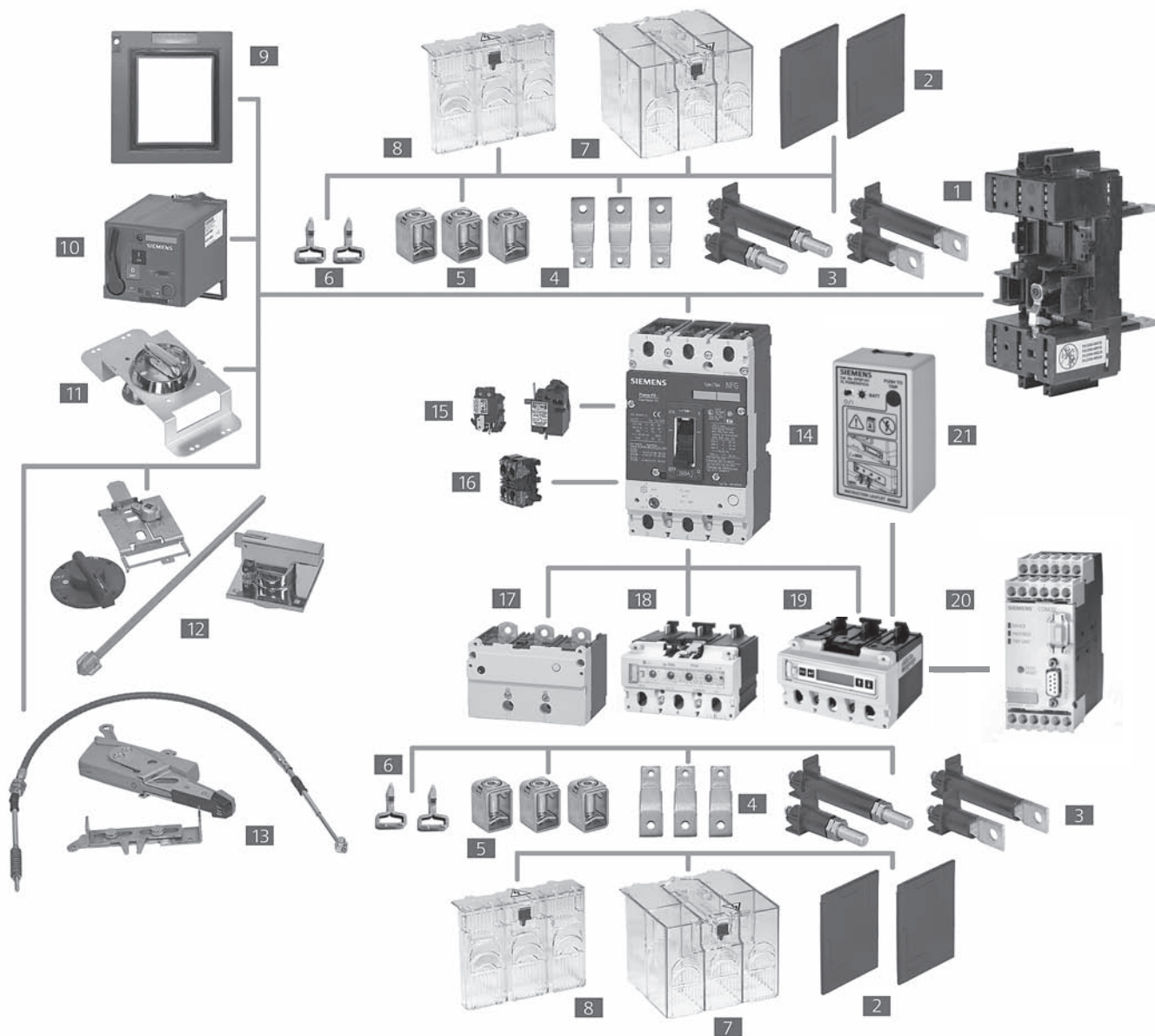

- | | | |
|--|---|--|
| 1 Base for Plug-In or Draw-Out | 9 Cover Frame for Door Cutout | 17 Thermal Magnetic Trip Unit (525) |
| 2 Interphase Barriers | 10 Stored Energy Operator | 18 Electronic Trip Unit (555) |
| 3 Rear Terminals – Flat and Round | 11 Rotary Handle Operator | 19 Elec. Trip Unit with LCD (586) |
| 4 Bus Extensions | 12 Variable Depth Rotary Operator | 20 Communication Module with ZSI |
| 5 Terminal Connectors | 13 Max Flex Operator | 21 Electronic Trip Unit Tester and LCD Power Supply |
| 6 Plug-In Terminal Blades | 14 Circuit Breaker | |
| 7 Extended Terminal Shield | 15 Shunt Trip or Undervoltage Releases | |
| 8 Standard Terminal Shield | 16 Auxiliary/Alarm Switches | |

7
MOLDED CASE
CIRCUIT BREAKERS

External Accessories

Operating Mechanisms

RHFF



RHVF12



RHVFBM

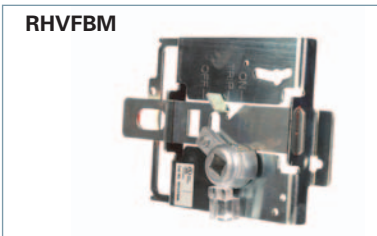

RHVM3RH



RHVMS12



RHVM12H



For DG to FG Frame
150 to 250 A

For JG to LG Frame
400 A to 600 A

Description

Catalog Number

Catalog Number

Through-Door Rotary Handle Operator Kit

Fixed depth and the handle is mounted directly on the circuit breaker.
Lockable knob (for up to 3 padlocks).
NEMA 1, 12

RHFF

RHFL

Red Handle Version
with red knob, yellow indicator plate
NEMA 1, 12

RHFFEM

RHFLEM

Door-Mounted Rotary Handle Operator Kit

Variable depth, door mounted handle.
Includes knob with masking frame,
indicator plate, detachable door coupling,
12" shaft, and breaker mounted rotary
operator. Lockable knob (for up to 3
padlocks).
NEMA 1, 12

RHVF12

RHVL12

Auxiliary Switch Kits

For Direct or Extended Rotary
Handle Operators (RHF and RHV).
Form C, Early Break type2 Aux. Switch Kit[Ⓞ]

Includes 1 switch with 5' wire
For Door-Mounted Operator
For Through-Door Operator

—
RHSFA1F

RHSLA1
RHSLA1F

Includes 2 switches with 5' wire
For Door-Mounted Operator
For Through-Door Operator

—
RHSFA2F

RHSLA2
RHSLA2F

Door-Mounted Rotary Operator Mechanism

Breaker mechanism only

RHVFBM

RHVLBM

Door-Mounted Rotary Handle Only

Standard version NEMA 1, 12
NEMA 3R
NEMA 4X

RHVM12H
RHVM3RH
RHVM4XH
RHVMEMH

RHVM12H
RHVM3RH
RHVM4XH
RHVMEMH

Red Handle version

NFPA-79 Handle Kit

Intermediate handle for NFPA-79 compliance
with door-mounted rotary operator

RHVF79H

RHVM79H

Extension Shaft Only, for Door Mounted Operator

2 inches (50.8mm)
3 inches (76.2mm)
12 inches (304.8 mm)
16 inches (406.4 mm)
24 inches (609.6mm) w/ support bracket

RHVMS02
—
RHVMS12
RHVMS16
RHVMS24

RHVMS02
—
RHVMS12
RHVMS16
RHVMS24

Ⓞ During manual operation, Early Break auxiliary switch contacts open before the breaker opens.

Description	For MG Frame 800 A	For NG to PG Frame 1200 to 1600 A	
	Catalog Number	Catalog Number	
Through-Door Rotary Handle Operator Kit Fixed depth, breaker mounted. For direct fitting to the circuit breaker. Lockable with up to 3 padlocks. NEMA 1, 12	—	—	—
Red Handle version with red knob, yellow indicator plate NEMA 1, 12	—	—	—
Door-Mounted Rotary Handle Operator Kit Variable depth, door mounted handle. Includes knob with masking frame, indicator plate, detachable door coupling, 12" shaft, and breaker mounted rotary operator. Lockable knob (for up to 3 padlocks). NEMA 1, 12	RHVM12	—	—
Auxiliary Switch Kits For Direct or Extended Rotary Handle Operators (RHF and RHV). Early Break type2 Aux. Switch Kit Includes 1 switch with 5' wire For Door-Mounted Operator For Through-Door Operator	RHSMA1 —	RHSPA1 —	—
Includes 2 switches with 5' wire For Door-Mounted Operator For Through-Door Operator	RHSMA2 —	RHSPA2 —	—
Door-Mounted Rotary Operator Mechanism Breaker mechanism only	RHVMBM	RHVPBM	
Door-Mounted Rotary Handle Only Standard version NEMA 1, 12 NEMA 3R NEMA 4X Red Handle version	RHVM12H RHVM3RH RHVM4XH RHVMEMH	RHVP3RH RHVP3RH RHVP4XH RHVPEMH	
NFPA-79 Handle Kit Intermediate handle for NFPA-79 compliance with door-mounted rotary operator	RHVM79H	RHVP79H	
Extension Shaft Only, for Door Mounted Operator 2 inches (50.8mm) 3 inches (76.2mm) 12 inches (304.8 mm) 16 inches (406.4 mm) 24 inches (609.6mm) w/ support bracket	RHVMS02 — RHVMS12 RHVMS16 RHVMS24	— RHVPS03 RHVPS12 — RHVPS24	— — — —

External Accessories

Operating Mechanisms

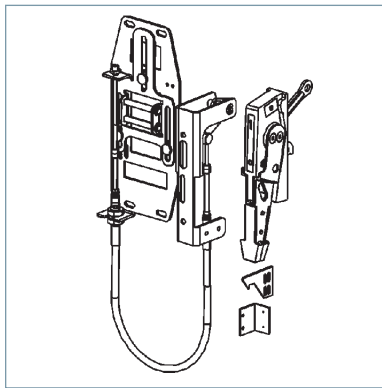
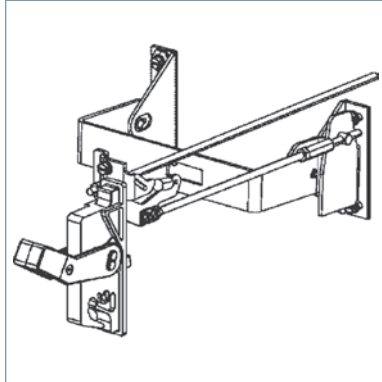

Description	For DG and FG Frame 150 to 250 A	For JG and LG Frame 400 to 600 A
	Catalog Number	Catalog Number
Variable Depth Flange Mounted Operator Kit Adjustable from 8" to 16" Complete kit, includes handle and variable depth operator. NEMA 1, 3R, 12 NEMA 4X IEC Black Handle NEMA 1, 3R, 12 NEMA 4X	FHV3R FHV4X FHV3RB FHV4XB	FHV3R FHV4X FHV3RB FHV4XB
Max-Flex™, Variable Depth Flange Mounted Operator Kit Complete kit, includes plastic handle, breaker operator, and cable. NEMA 1, 3R, 12 For DG and FG operators, the cable is 36", all others are 48" May be right- or left-hand mounted	MF3R	MF3R
Handle Only, for Max-Flex™ Variable Depth NEMA 1, 3R, 12 Plastic NEMA 1, 3R, 12 Steel - epoxy coated NEMA 4, 4X Steel - chrome plated Solid color (all gray) Plastic ^① NEMA 1, 3R, 12 Solid color (black handle) Steel epoxy coated ^① NEMA 1, 3R, 12	MF3R MF3RS MF4X MF3RB MF3RSB	MF3R MF3RS MF4X MF3RB MF3RSB
Breaker Operator Mechanism Only, for Max-Flex™	MFMF	MFML
Cable Only, for Max-Flex™ Variable Depth 36" 48" 60" 72" 84" 96" 120" 144"	MCF036 MCF048 MCF060 MCF072 MCF084 MCF096 MCF120 MCF144	MCF036 MCF048 MCF060 MCF072 MCF084 MCF096 MCF120 MCF144
Handle Auxiliary Switch Form C (1NO - 1NC), early break ^② 1 Aux. switch 2 Aux. switch	MFSA1 MFSA2	MFSA1 MFSA2

① Max-Flex™ handles are available with solid gray or black handles instead of the customary "Red for On" flange handle.

The black handle is preferred for IEC markets, where red handles have a specific meaning.

② During manual operation, Early Break aux. contacts open before the breaker opens.

Description	For MG Frame 800 A	For NG Frame 1200 A	For PG Frame 1600 A
	Catalog Number	Catalog Number	Catalog Number
Variable Depth Flange Mounted Operator Kit Adjustable from 8" to 16" Complete kit, includes handle and variable depth operator.			
NEMA 1, 3R, 12	—	—	
NEMA 4X	—	—	
IEC Black Handle	—	—	
NEMA 1, 3R, 12	—	—	
NEMA 4X	—	—	
Max-Flex™, Variable Depth Flange Mounted Operator Kit Complete kit, includes plastic handle, breaker operator, and cable. NEMA 1, 3R, 12 For DG and FG operators, the cable is 36", all others are 48" May be right- or left-hand mounted	MFKM3R	MFKP3RS	MFKP3RS
Handle Only, for Max-Flex™ Variable Depth			
NEMA 1, 3R, 12 Plastic	MFHM3R	—	—
NEMA 1, 3R, 12 Steel - epoxy coated	MFHM3RS	MFHP3RS	MFHP3RS
NEMA 4, 4X Steel - chrome plated	MFHM4X	MFHP4X	MFHP4X
Solid color (all gray) Plastic ^①			
NEMA 1, 3R, 12	MFHM3RB	—	—
Solid color (black handle) Steel epoxy coated ^①			
NEMA 1, 3R, 12	MFHM3RSB	MFHP3RSB	MFHP3RSB
Breaker Operator Mechanism Only, for Max-Flex™	MFMM	MFMP	MFMP
Cable Only, for Max-Flex™ Variable Depth			
36"	MFCM036	—	—
48"	MFCM048	MFCP048	MFCP048
60"	MFCM060	MFCP060	MFCP060
72"	MFCM072	MFCP072	MFCP072
84"	MFCM084	—	—
96"	MFCM096	MFCP096	MFCP096
120"	MFCM120	MFCP120	MFCP120
144"	MFCM144	MFCP144	MFCP144
Handle Auxiliary Switch Form C (1NO - 1NC), early break ^② 1 Aux. switch 2 Aux. switch	MFSPA1 MFSPA2	MFSPA1 MFSPA2	MFSPA1 MFSPA2

① Max-Flex™ handles are available with solid gray or black handles instead of the customary "Red for On" flange handle.

The black handle is preferred for IEC markets, where red handles have a specific meaning.

② During manual operation, Early Break aux. contacts open before the breaker opens.

External Accessories

Operating Mechanisms

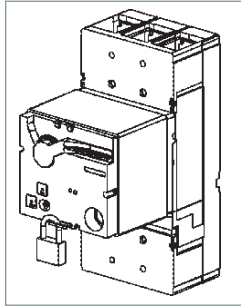

Description	For DG to FG Frame 150 to 250 A	
	Catalog Number	
Stored Energy and Motor Operators Lockable with up to 3 padlocks.		
AC Voltage DC Voltage	Stored Energy Type	
— 24	SEAFB	
42-48 42-48	SEAFM	
60 60	SEAFY	
110-127 110-127	SEAFN	
220-250 220-250	SEAFR	
Cylinder Locks for Field Installation	CLKF	

Plug-In and Draw-Out Bases



Description	For DG Frame 150 A	For FG Frame 250 A
	Catalog Number	Catalog Number
Plug-in Mounting Base Assembly Includes base, terminal blade kit, sec. terminal block assembly, base trip interlock, and mounting hardware.		
Rear Connected 3-pole	PCBDR3	PCBFR3
Front Connected 3-pole	PCBDF3	PCBFF3
Draw-out Assembly Includes base, position indicator switch, socket, base trip interlock, crank handle, connectors, and necessary shields.		
Rear Connected 3-pole	DCADR3	DCAFR3
Front Connected 3-pole (Draw-out assembly includes side plates and all hardware)	DCADFC3	DCAFFC3
Hex Wrench for racking draw-out assembly and position indicator	DCHP	DCHP
Position Indicator Switch Form "C" switch to indicate breaker engaged/de-engaged position. ^①	DCIP	DCIP
Secondary Terminal Block Assy. Accessory connections for plug-in or draw-out breakers. Pre-wired plug and block with 8 terminal points. ^②	PCTF83	PCTF83
Plug-In Spare Breaker Kit Set of 6 terminal blades, 2 terminal shield, & 1 trip interlock	PCXD3	PCXF3
Draw-out Spare Breaker Kit Set of 6 terminal blades, & 1 trip interlock	DCXD3	DCXF3
Spare Breaker Trip Interlock	PCXFT	PCXFT

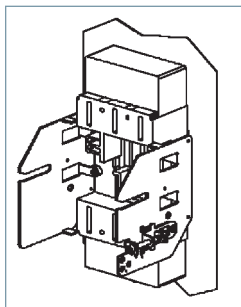
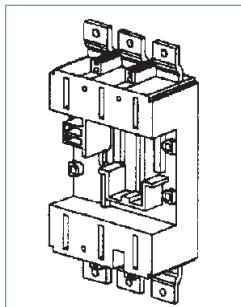

7
MOLDED CASE
CIRCUIT BREAKERS

① Up to 2 position indicator switches may be mounted per plug-in or draw-out base.

② Up to 2 plugs per breaker (16 terminal points) may be mounted on DG, and FG breakers. Up to 3 plugs per breaker (24 terminal points) may be mounted on JG, LG, MG, NG, and PG breakers.

For JG to LG Frame
400 to 600 A

For MG Frame
800 A

For NG to PG Frame
1200 to 1600 A

Catalog Number	Catalog Number	Catalog Number
Stored Energy Type SEALB SEALM SEALY SEALN SEALR CLKP	Stored Energy Type SEAMB SEAMM SEAMY SEAMN SEAMR CLKP	Motor Operator Type MTRPB MTRPM MTRPY MTRPN MTRPR CLKP

For JG Frame
400 A

For LG Frame
600 A

For MG Frame
800 A

For NG Frame
1200 A

For PG Frame
1600 A

Catalog Number	Catalog Number	Catalog Number	Catalog Number	Catalog Number
PCBJRC3	PCBLRC3	PCBMRC3	PCBNRC3	—
PCBJFC3	PCBLFC3	—	—	—
DCAJRC3	DCALRC3	—	—	—
DCAJFC3	DCALFC3	—	—	—
DCHP	DCHP	—	—	—
DCIP	DCIP	—	—	—
PCTL83	PCTL83	—	—	—
PCXJ3	PCXL3	—	—	—
DCXJ3	DCXL3	—	—	—
PCXLT	PCXLT	—	—	—

External Accessories

Connections

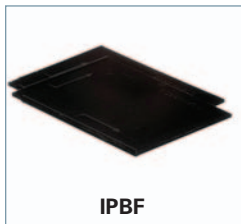
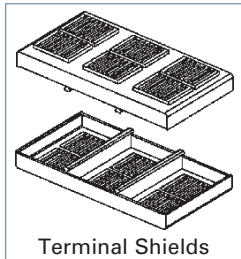
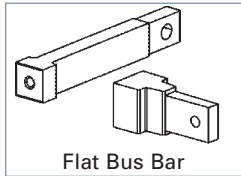
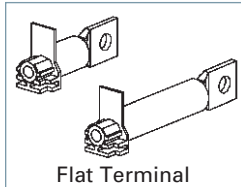
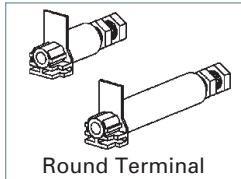
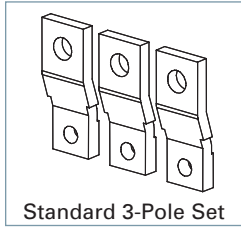

Description	For DG Frame 150 A	For FG Frame 250 A
	Catalog Number	Catalog Number
Front Bus Bar Connections Includes nut keeper plates and shield. Standard (straight) 3-Pole Set Bus Bar Connection Strap Kit Includes 6 - Bus Bars, 6 Nut Keepers & Shields 100% rated applications	FBCE3 — —	FBCE3 — —
Rear-Connecting Studs Short length round term. (1piece) Long length round term. (1piece) 3-Pole round term. kit, 2 short + 1 long Short length flat term. (1piece) Long length flat term. (1piece) 3-Pole flat term. kit, 2 short + 1 long Flat bus bar type (1 piece) 3-Pole set of flat bus bar	RTLDSR RTLDLR SRTDR3 RTLDSF RTLDLF SRTDF3 — —	RTLFSR RTLFLR SRTFR3 RTLFSF RTLFLF SRTFF3 — —
Terminal Shields Includes 2 terminal shields. 3-Pole Standard Shield 3-Pole Extended Shield	TSSF3 TSLF3	TSSF3 TSLF3
Interphase Barriers Set of 2 barriers Also fits plug-in and draw-out bases.	IPBF	IPBF
Lug Mounting Assy.	—	—
Breaker Mounting Base Front connected Rear connected	— —	— —

7
MOLDED CASE
CIRCUIT BREAKERS

For JG Frame 400 A	For LG Frame 600 A	For MG Frame 800 A	For NG Frame 1200 A	For PG Frame 1600 A
Catalog Number	Catalog Number	Catalog Number	Catalog Number	Catalog Number
FBCJ3 —	FBCL3 —	FBCM3 —	SSBP SSBPH	SSBP SSBPH
RTLJSR RTLJLR SRTJR3 RTLJSF RTLJLF SRTJF3 — —	— — — — — — RTLLSF SRTL3F3	— — — — — — RTLMSF SRTMF3	— — — — — — RTLNSF SRTNF3	— — — — — — — —
TSSL3 TSL3	— —	TSSM3 TSLM3	TSSP3 TSLP3	TSSP3 TSLP3
IPBM	IPBM	IPBM	IPBP	IPBP
—	—	—	—	LMAP1600 ²
— —	— —	— —	— —	MBPG1600 MBPG1601

① Not for use with standard AI terminals. Use Standard Shield for rear connection and Extended Shield for bus-bar connection.

② Kit includes connection for one side of breaker only. Order quantity 2 if connecting line and load side.

External Accessories

Connections

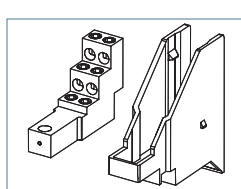
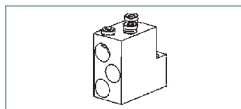
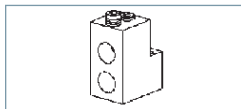
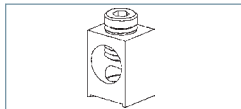
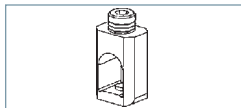
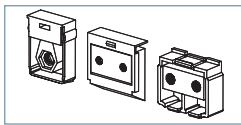

Note: pictures provide graphical representations only.

Description	For DG Frame 150 A	For FG Frame 250 A
	Catalog Number	Catalog Number
Nut Keeper Plates For ring/tongue terminal or bus bar connections. (For metric threads on other than the JG frame, change "TNK" to "TMK") 1 Nut Keeper Plate Kit of 3	TNKD TNKD3	TNKF TNKF3
Mechanical Lugs <i>Steel Wrap Around Body (Cu Wire Only)</i> Cable Size; (cables per phase) Single Lug Kit of 3	#8-1/0; 1-hole TW1DG20 3TW1DG20	#4-350 kcmil; 1-hole TW1FG350 3TW1FG350
<i>Aluminum Body (Al or Cu Wire)</i> Cable Size; (cables per phase) Single Lug Kit of 2 Kit of 3	#6-3/0; 1-hole TA1DG30 — 3TA1DG30	#4-350 kcmil; 1-hole TAW1FG350 — 3TAW1FG350
Cable Size; (cables per phase) Single Lug Kit of 2 Kit of 3	— — — —	— — — —
Cable Size; (cables per phase) Single Lug	— —	— —
Copper Body (Cu Wire Only) Cable Size; (cables per phase) Single Lug Kit of 2 Kit of 3	#6-3/0; 1-hole TC1DG30 [Ⓞ] — 3TC1DG30 [Ⓞ]	#4-350 kcmil; 1-hole TCW1FG350 [Ⓞ] — 3TCW1FG350 [Ⓞ]
Cable Size; (cables per phase) Single Lug	— —	— —
Compression Lugs Cable Size; (cables per phase) Kit of 2 Kit of 3 Cable Size; (cables per phase) Kit of 2 Kit of 3 Cable Size; (cables per phase) Kit of 3	#14-2/0; 1-cable 2CLD20 3CLD20 — — —	#4-350 kcmil; 1-cable — 3CLF350 — — —
Distribution Lugs (Cu Wire Only) Cable Size; (cables per phase) Single Lug Kit of 3 Cable Size; (cables per phase) Single Lug Kit of 3	#14-#2; 3-hole TA3DG02 3TA3DG02 #14-#4; 6-hole TA6DG04 3TA6DG04	#14-#1; 2-hole and #14-2/0; 1-hole TA3FG20 3TA3FG20 #14-#4; 6-hole TA6FG04 3TA6FG04
Control Wire Terminals Control Wire Terminal (Single) Control Wire Terminal (Kit of 3)	— —	— —

Ⓞ Required for 100% rated breakers. Requires 90°C cable sized at 75°C ampacity.

For JG Frame 400 A	For LG Frame 600 A	For MG Frame 800 A	For NG Frame 1200 A	For PG Frame 1600 A
Catalog Number	Catalog Number	Catalog Number	Catalog Number	Catalog Number
TMKJ TMKJ3 <i>metric only</i>	TNKL TNKL3	TNKM TNKM3	TNKP TNKP3	TNKP TNKP3
1/0-600 kcmil; 1-hole TW1JG600 3TW1JG600	— — —	— — —	— — —	— — —
3/0-250 kcmil; 2-hole TA2JG250 — 3TA2JG250 AL: 250-750 kcmil CU: 3/0-600 kcmil; 1-hole TA1JG750 — 3TA1JG750 — — —	#2-600 kcmil; 2-hole — — 3TA2LG600LD ^① 3TA2LG600LN ^② AL: 250-750 kcmil CU: 3/0-600 kcmil; 1-hole TA1JG750 (400A max) — 3TA1JG750 (400A max) — — —	1/0-500 kcmil; 3-hole TA3MG500 3TA3MG500 500 -750 kcmil; 2-hole TA2MG750 — 3TA2MG750 #2-600 kcmil; 3-hole — 3TA3MG600 ^③ (Kit of 3)	1/0-500 kcmil; 4-hole — 2TA4NG500 3TA4NG500 3TA4NG500H ^④ 500 -750 kcmil; 3-hole — 2TA3NG750 3TA3NG750 —	1/0-750 kcmil; 6-hole — — 3TA6PG750 ^⑤ 600-750 kcmil; 4-hole TA4P750 ^⑥ — — 300-600 kcmil; 5; 6-hole TA5P600 ^⑥ TA6R600 ^⑥ —
3/0-250 kcmil; 2-hole TC2JG250 ^③ — — 3/0-750 kcmil; 1-hole TC1JG750 ^③	#2-600 kcmil; 2-hole — — 3TC2LG600LD ^{①③} 3TC2LG600LN ^{②③} — —	1/0-500 kcmil; 3-hole TC3MG500 ^③ — — — —	1/0-500 kcmil; 4-hole — — 3TC4NG500 ^③ — —	— — — — — 300-600 kcmil; 5-hole TC5R600 ^{③④}
#6-350 kcmil; 1-cable — 3CLJ350 250-600 kcmil; 1-cable 3CLJ600 — —	#6-350 kcmil; 2-cable — 6CLL350 (kit of 6) 250-750 kcmil; 1-cable 3CLL750 — 250-600 kcmil; 2-cable 6CLL600 (kit of 6) —	— — — — — — —	1/0-500 kcmil; 4-cable — 12CLN500 (kit of 12) — — — — —	— — — — — — —
#14-#4; 12-hole TA12JG04 3TA12JG04 #14-2/0; 6-hole TA6JG20 3TA6JG20	— — — — — —	— — — — — —	— — — — — —	— — — — — —
TA2JG250PT —	— 3TA2LG600LNPT	TA3MG500PT —	— 3TA4NG500PT	— —

7
 MOLDED CASE
 CIRCUIT BREAKERS

All lug kits include the nut keepers.
 ① Mounted on Load Side Only.
 ② Mounted on Line Side Only.

③ Required for 100% rated breakers. Requires 90°C cable sized at 75°C ampacity.
 ④ Requires extended modified shield.

⑤ Used only with LMAP1600 mounting base.
 ⑥ Used only with MBPG1600 or MBPG1601 mounting base.

External Accessories

General

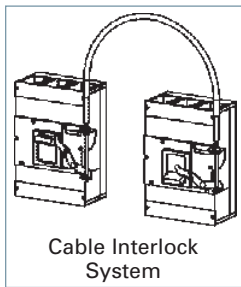
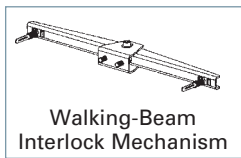
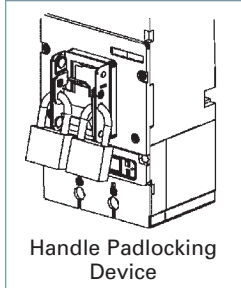

Description	For DG Frame 150 A	For FG Frame 250 A
	Catalog Number	Catalog Number
Handle Padlocking Device To padlock breaker toggle in the "OFF" position. Accepts up to 3 padlocks with 5–8 mm shackles.	HPLF	HPLF
Handle Blocking Device For holding the handle in the "ON" position. Not a lockout/tagout device.	HBDF	HBDF
Walking-Beam Interlock Mechanism Provides mechanical interlocking between two adjacent circuit breakers. Fixed mounted breakers Note: Both breakers must be of the same frame size.	WBMFFM	WBMFFM
Cable Interlock Mechanism Provides mechanical interlocking between 2 circuit-breakers - includes operator mechanism for one circuit breaker only. Combination with the next larger or smaller frame size is possible.	CBTF	CBTF
Interlock Cable Cable only, to connect 2 circuit breakers. Cable length 18 in. .46m (recommended up to 250A) Cable length 36 in. .91m (recommended from 400–800A) Cable length 54 in. 1.37m (recommended from 1200–1600A)	CBCF18 CBCM36 CBCP54	CBCF18 CBCM36 CBCP54
Mounting Screw Kit Includes the necessary hardware to mount a circuit breaker to the user's prepared surface Kit with 2 screws (SAE thread) Kit with 4 screws (SAE thread)	MSKF2 MSKF4	MSKF2 MSKF4
Trip Adjustment Sealing Cover Includes a trip unit cover to prevent tampering or adjustment of trip settings. Seal not included. Thermal-Magnetic Trip Units	3VL97008BL00 TSCFTM	3VL97008BL00 TSCFTM

7

MOLDED CASE
CIRCUIT BREAKERS

For JG Frame 400 A	For LG Frame 600 A	For MG Frame 800 A	For NG Frame 1200 A	For PG Frame 1600 A
Catalog Number	Catalog Number	Catalog Number	Catalog Number	Catalog Number
HPLL	HPLL	HPLM	HPLP	HPLP
HBDL	HBDL	HBDM	HBDP	HBDP
WBMLFM	WBMLFM	WBMMFM	WBMPFM	WBMPFM
CBTL	CBTL	CBTM	CBTP	CBTP
— CBCM36 CBCP54	— CBCM36 CBCP54	— CBCM36 CBCP54	— — CBCP54	— — CBCP54
— MSKL4	— MSKL4	— MSKM4	— MSKP4	— MSKP4
3VL97008BL00 TSLTLM	3VL97008BL00 TSLTLM	3VL97008BL00 TSCMTM	3VL97008BL00 —	3VL97008BL00 —

External Accessories

Ground Sensors & Electronic Accessories

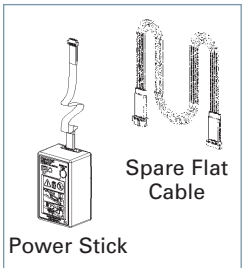

Description	For DG Frame 150 A	For FG Frame 250 A
	Catalog Number	Catalog Number
Neutral Current Transformer (Ground Sensor, N-pole)		
Neutral = 35/60A	NGSD060	—
Neutral = 100A	NGSF100	NGSF100
Neutral = 150A	NGSF150	NGSF150
Neutral = 250A	—	NGSJ250
Neutral = 400A	—	—
Neutral = 600A	—	—
Neutral = 800A	—	—
Neutral = 1000/1200A	—	—
Neutral = 1600A	—	—
Communications & Electronics		
Portable Test Set.	ELTPHB	ELTPHB
Power Stick - Hand held, battery operated power supply for LCD trip units. (Requires two 9V batteries.) Trip testing for both 555 & 586 trip units.	EPSP18V	EPSP18V
Spare flat cable for Power Stick.	COMPCA	COMPCA
COM20 Profibus Communications Module with ZSI for electronic trip units (order cable separately)	COMPRO20	COMPRO20
COM21 Modbus Communications Module with ZSI for electronic trip units (order cable separately)	COMMOD21	COMMOD21
Cable for COM20/21, 1.5 m (4.9 ft)	COMKIT3	COMKIT3
Cable for COM20/21, 3.0 m (9.8 ft)	COMKIT6	COMKIT6
Addressing Plug - assigns a field bus address without a PC by plugging into COM20/21	3UF79100AA000	3UF79100AA000

Door Cutouts & Extensions

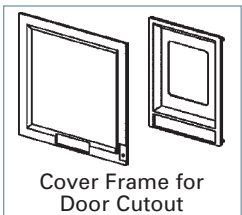

Cover Frame for Door Cutout For fixed or plug-in mounted circuit breakers. (IP30) 2-Pole & 3-Pole	BZLF3	BZLF3
For breakers with stored energy operator. (IP40) Circuit-breaker draw-out mounted and toggle handle operated. Kit includes cover frame (bezel) and escutcheon as needed. (IP40) (not for use with rotary handle or stored energy operator)	BZLFRHSE	BZLFRHSE
Toggle Handle Extension For spare or replacement. (One is included with each NG - PG frame.)	—	—

For JG Frame 400 A	For LG Frame 600 A	For MG Frame 800 A	For NG Frame 1200 A	For PG Frame 1600 A
Catalog Number	Catalog Number	Catalog Number	Catalog Number	Catalog Number
— — — NGSJ250 NGSL400 — — — —	— — — — NGSL400 NGSM600 — — — —	— — — — — NGSM600 NGSN800 — — —	— — — — — — NGSN800 NGSP120 —	— — — — — — — NGSP120 NGSP160
ELTPHB	ELTPHB	ELTPHB	ELTPHB	ELTPHB
EPSP18V	EPSP18V	EPSP18V	EPSP18V	EPSP18V
COMPCA	COMPCA	COMPCA	COMPCA	COMPCA
COMPRO20	COMPRO20	COMPRO20	COMPRO20	COMPRO20
COMMOD21	COMMOD21	COMMOD21	COMMOD21	COMMOD21
COMKIT4	COMKIT4	COMKIT5	COMKIT5	COMKIT5
COMKIT7	COMKIT7	COMKIT8	COMKIT8	COMKIT8
3UF79100AA000	3UF79100AA000	3UF79100AA000	3UF79100AA000	3UF79100AA000
BZLL3	BZLL3	BZLM3	BZLP3	BZLP3
BZLLRHSE	BZLLRHSE	BZLMRHSE	BZLPRHSE	BZLPRHSE
BZLLBDC	BZLLBDC	BZLMBDC	BZLPBDC	BZLPBDC
THEL	THEL	THEM	THEP	THEP

VL Circuit Breakers

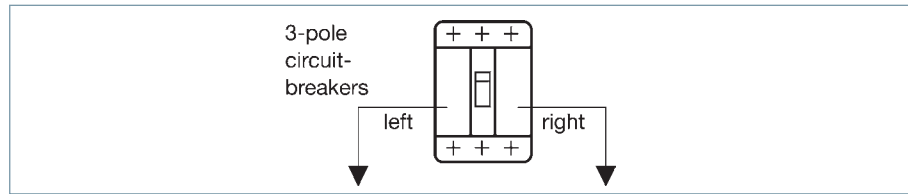

Locations of Internally Mounted Accessories

Frame Family	Left Pocket	Right Pocket
DG*, FG*, JG, LG 150 to 600A	Up to 3 Auxiliary Switches	Shunt Trip or UVR or up to 3 Auxiliary Switches or up to 2 Auxiliary Switches + 1 Alarm Switch
	Up to 2 Auxiliary Switches + 1 Alarm Switch	Shunt Trip or UVR or up to 3 Auxiliary Switches or up to 2 Auxiliary Switches + 1 Alarm Switch
MG, NG, PG 800 to 1600A	Up to 4 Auxiliary Switches	Shunt Trip or UVR or up to 4 Auxiliary Switches
	Up to 2 Auxiliary Switches + 2 Alarm Switches	Shunt Trip or UVR or up to 4 Auxiliary Switches

* Except DG and FG breakers with Electronic Trip Units. Due to the location of the Magnetic Latch, the Left Pocket is not available for accessories.

Accessory Information

- Aux. Switch is an Auxiliary Switch, 1A or 1B contact
- Alarm Switch has 1A or 1B contact
- UVR is an Undervoltage Release
- The standard location for factory mounted Auxiliary and Alarm Switches is the Left Pocket

Accessory Maximums

DG, FG, JG, LG Maximum Accessories:

- Maximum of six (6) switches total
- DG, FG Maximum of two (2) Alarm Switches, one each in the Left and Right Pockets. JG, LG Max. of 1 Alarm, Left only

MG, NG, PG Maximum Accessories:

- Maximum of eight (8) switches total
- Maximum of two (2) Alarm Switches, Left Pocket only

For applications using COMMOD20 and COMMOD21 for communication using Modbus or Profibus

DG, FG

COMKIT3 & COMKIT6 provide auxiliary contact kit. May add only one or two contact blocks for Alarm or Auxiliary function.

JG, LG

COMKIT4 & COMKIT7 provide auxiliary contact kit mounted in left pole pocket. One contact block can be added for Auxiliary function. Right pole pocket available for other release or an additional Auxiliary contact kit.

MG, NG, PG

COMKIT5 & COMKIT8 provide auxiliary contact kit mounted in Left pole pocket. Two contact blocks can be added for Auxiliary function and one for Alarm function. Right pole pocket available for other release or an additional Auxiliary Contact kit.

Suffix for factory mounted Switch Combinations

If the frame is:	And you need these functions:	Then add this suffix:	Device Catalog Number
DG, FG, JG or LG	1 Alarm Switch 1 NO Alarm 1 NC Alarm	A1	ASKL1
DG, FG, JG or LG	2 Aux. Switches 1 NO + 1 NC Aux. Contacts	A2	ASKL2
DG, FG, JG or LG	2 Aux. + 1 Alarm Switches 1NO + 1NC Aux. and 1NC Alarm 2NO Aux. and 1NC Alarm	A3	ASKL3
MG, NG or PG	2 Aux. + 2 Alarm Switches 1NO + 1NC Aux. and 1NO + 1NC Alarm 2NO Aux. and 2NC Alarm 2NC Aux. and 2NO Alarm	A3	ASKP3
MG, NG or PG	4 Aux. Switches 2NO + 2NC Aux.	A4	ASKP4

Suffix for factory mounted Shunt Trips

If the frame is:	And you need these functions:	Then add this suffix:	Device Catalog Number
DG, FG, JG or LG	24V DC 48-60V DC 110-127V DC 220-250V DC 48-60V AC 110-127V AC 208-277V AC 380-600V AC	RB RC RD RE RM RN RS RV	STRLB24DC STRLC60DC STRLD125DC STRLE250DC STRLM60 STRLN120 STRLS277 STRLV600
MG, NG or PG	24V DC 48-60V DC 110-127V DC 220-250V DC 48-60V AC 110-127V AC 208-277V AC 380-600V AC	RB RC RD RE RM RN RS RV	STRPB24DC STRPC60DC STRPD125DC STRPE250DC STRPM60 STRPN120 STRPS277 STRPV600

Suffix for factory mounted Undervoltage Releases

If the frame is:	And you need these functions:	Then add this suffix:	Device Catalog Number
DG, FG, JG or LG	12V DC 24V DC 48V DC 60V DC 110-127V DC 220-250V DC 24V AC 110-127V AC 220-240V AC 208V AC 277V AC 380-415V AC 440-480V AC	UA UB UC UG UD UE UK UN UR UP US UT UU	UVRLA12DC UVRLB24DC UVRLC48DC UVRLG60DC UVRLD125DC UVRLE250DC UVRLL24 UVRLN120 UVRLR240 UVRLP208 UVRLS277 UVRLT415 UVR LU480
MG, NG or PG	12V DC 24V DC 48V DC 60V DC 110-127V DC 220-250V DC 110-127V AC 220-240V AC 208V AC 277V AC 380-415V AC 440-480V AC	UA UB UC UG UD UE UN UR UP US UT UU	UVRPA12DC UVRPB24DC UVRPC48DC UVRPG60DC UVRPD125DC UVRPE250DC UVRPN120 UVRPR240 UVRPP208 UVRPS277 UVRPT415 UVRPU480

Technical Data

		DG	FG	JG	LG	MG	NG	PG
Max rated continuous current		150	250	400	600	800	1200	1600
Rated operational voltage								
NEMA	V AC	600	600	600	600	600	600	600
IEC	V AC	690	690	690	690	690	690	690
Rated Impulse Withstand Voltage								
Main conducting paths	kV	8	8	8	8	8	8	8
Auxiliary circuits	kV	4	4	4	4	4	4	4
Ambient Temperature Range	°C	-25 to +75	-25 to +75	-25 to +75	-25 to +75	-25 to +75	-25 to +75	-25 to +75
High Ambient Derating (thermal-mag.)	50°C	93%	93%	93%	93%	95%	95%	95%
	60°C	86%	86%	86%	86%	86%	86%	80%
	70°C	80%	80%	80%	80%	80%	80%	74%
Operating Cycles		20,000	20,000	20,000	10,000	5,000	3,000	3,000
Max switching rate (per hour)		120	120	120	60	60	30	30
Power loss (at max. rated current)								
Thermal-magnetic	W	15 – 48	32 – 80	60 – 175	85 – 230	170 – 250	150 – 220	200 – 260
Electronic trip unit	W	40	60	90	160	250	210	260
IEC ①								
Time constant t = 10 ms								
1 current path								
2 current paths in series								
3 current paths in series								
Up to 250V DC		—	—	—	—	—	—	—
440V DC								
600V DC								
NEMA								
Time constant t = 8 ms								
2 poles switching								
1 current path								
250V DC Max. ②		30	30	30	30	42	42	42
3 poles switching								
2 current paths in series								
500V DC Max. ②		18	25	35	35	65	65	65
Accessories								
Auxiliary/ Alarm Switch								
Current rating (1 or 2 switches)		10	10	10	10	10	10	10
Current rating (3 or 4 same switch)	A	5	5	5	5	5	5	5
Shunt Trip								
Pick-up voltage	V	0.7 – 1.1	0.7 – 1.1	0.7 – 1.1	0.7 – 1.1	0.7 – 1.1	0.7 – 1.1	0.7 – 1.1
Power Consumption (short-time) at:								
48 – 60 V AC	VA	401 – 501	401 – 501	401 – 501	401 – 501	401 – 501	401 – 501	401 – 501
110 – 127 V AC	VA	424 – 489	424 – 489	424 – 489	424 – 489	424 – 489	424 – 489	424 – 489
208 – 277 V AC	VA	533 – 736	533 – 736	533 – 736	533 – 736	533 – 736	533 – 736	533 – 736
380 – 600 V AC	VA	408 – 645	408 – 645	408 – 645	408 – 645	408 – 645	408 – 645	408 – 645
24 V DC	W	594	594	594	594	594	594	594
48 – 60 V DC	W	740 – 925	740 – 925	740 – 925	740 – 925	740 – 925	740 – 925	740 – 925
110 – 127 V DC	W	559 – 648	559 – 648	559 – 648	559 – 648	559 – 648	559 – 648	559 – 648
220 – 250 V DC	W	722 – 820	722 – 820	722 – 820	722 – 820	722 – 820	722 – 820	722 – 820
Max. Operating time	ms	50	50	50	50	50	50	50

① Consult Siemens for short circuit values.

② Review individual frame and type values.

Technical Data

		DG	FG	JG	LG	MG	NG	PG
Undervoltage Trip								
Drop voltage (percentage)	V	35% – 70%	35% – 70%	35% – 70%	35% – 70%	35% – 70%	35% – 70%	35% – 70%
Pick-up voltage (percentage)	V	70% – 85%	70% – 85%	70% – 85%	70% – 85%	70% – 85%	70% – 85%	70% – 85%
Power consumption (continuous) at:								
110 – 127 V AC	VA	1	1	1	1	1.1	1.1	1.1
220 – 250 V AC	VA	2.1	2.1	2.1	2.1	2.1	2.1	2.1
208 V AC	VA	1.2	1.2	1.2	1.2	1.2	1.2	1.2
277 V AC	VA	1.4	1.4	1.4	1.4	1.4	1.4	1.4
380 – 415 V AC	VA	1.9	1.9	1.9	1.9	1.9	1.9	1.9
440 – 480 V AC	VA	2.2	2.2	2.2	2.2	2.2	2.2	2.2
500 – 525 V AC	VA	2.5	2.5	2.5	2.5	2.5	2.5	2.5
600 V AC	VA	2.8	2.8	2.8	2.8	2.8	2.8	2.8
Max. opening time	ms	50	50	50	50	50	50	50
Motorized Operating Mechanism								
Motor with stored energy mechanism (synchronizable)		X	X	X	X			
Motor Operator						X	X	X
Max. switching rate (per hour)		120	120	120	60	60	30	30
Command duration	ms	20 – 50	20 – 50	20 – 50	20 – 50	20 – 50	—	—
Closing time	ms	<100	<100	<100	<100	<100	<5,000	<5,000
Charging time	s	<5	<5	<5	<5	<5	<5	<5
Break time	s	<5	<5	<5	<5	<5	<5	<5
Power consumption	VA/W	<100	<100	<200	<250	<250		
Inrush (A)								
Control Voltages								
		110 – 127 V AC						
		220 – 250 V AC						
		24 V DC						
		48 V DC						
		60 V DC						
Operating Range		85 – 110% of rated control voltage						

Technical Data

Unusual Operating Conditions

Reference

Note: The information provided on this and the next page is intended for reference and recommendation only. Because several variables can act on a circuit breaker's performance at the same time, the data below is based less on controlled testing, than on experience and engineering judgment. Contact Siemens for further information on special conditions and treatment.

High Ambient Temperatures

Because thermal-magnetic trip breakers are temperature sensitive and calibrated for a specific ambient of 40° C (104° F) (average enclosure temperature), a higher ambient will cause the breaker to trip at lower current than its nameplate rating, in other words, causing the breaker to "derate" (see Table 1). Similarly, the current carrying capacity of a circuit conductor is based upon a certain ambient temperature, a higher ambient will reduce its current carrying capacity, causing it to "derate." Thus, with a fluctuating temperature, a thermal-magnetic breaker will derate nearly parallel with its connected circuit conductors and maintain close circuit protection. If the application temperature exceeds 40° C (104° F) and is known, either a breaker specially calibrated for the higher ambient or one oversized according to Table 1 may be selected. In a case such as this, the circuit conductors should be oversized as well.

Siemens Electronic Trip Unit Breakers are insensitive to temperature changes. However, they do include circuitry to protect the components from abnormally high temperatures.

Altitude

Reduced air density at altitudes greater than 6600 ft. (2000 meters) affects the ability of a molded case circuit breaker to transfer heat and interrupt faults. Therefore, circuit breakers applied at these altitudes should have interrupting, insulation and continuous currents derated as indicated in Figure 1.

Table 1 – Temperature derating data for thermal-magnetic breakers

Reference Ampere Rating at 40° C (104° F)	Ampere Rating at:		Siemens Breaker Frames
	50° C (122° F)	60° C (140° F)	
50	46	42	DG
60	56	52	
70	65	60	
90	84	78	
100	94	87	
125	114	100	
150	136	120	
175	159	140	
200	182	160	
225	205	180	
250	235	220	
300	276	252	FG
350	325	301	
400	372	340	JG
500	468	435	
600	564	525	
700	658	613	LG
800	754	704	
900	828	749	MG
1000	900	825	
1200	1090	1000	NG
1400	1304	1148	
1600	1500	1320	PG

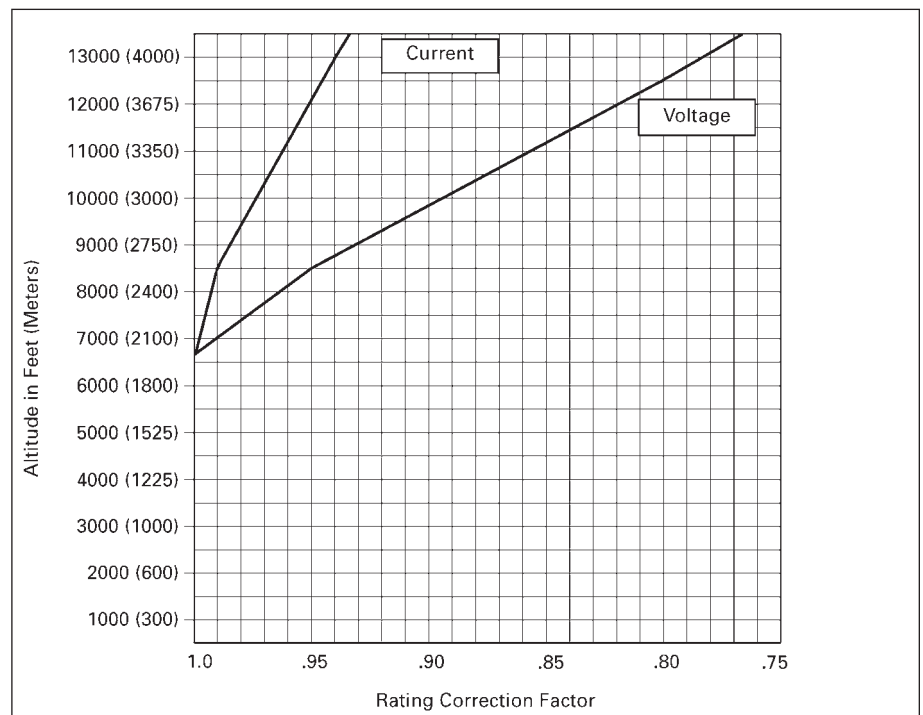

Figure 1 – Altitude adjustment

Unusual Operating Conditions 400 Hz Systems

Circuit Breaker Derating Required

This table lists the maximum continuous current carrying capacity for Siemens breakers at 400Hz. Due to the increased resistance of the copper sections resulting from the skin effect produced by eddy currents at these frequencies, circuit breakers in many cases require derating. The thermal derating on these devices is based upon 100%, three phase application in open air in a maximum of 40°C (104° F) with 48 in. (1219 mm) of the specified cable or bus at the line and load side. Additional derating of not less than 20% will be required if the circuit breaker is to be utilized in an enclosure. Further derating may be required if the enclosure ambient temperature exceeds 40°C(104° F).

Cable and Bus Sizing

The cable and bus sizes to be utilized at 400Hz are not based on standard National Electric Codes tables for 60Hz application. Larger cross sections are necessary at 400Hz. All bus bars specified are based upon mounting the bars in the vertical plane to allow maximum air flow. All bus bars are spaced at a minimum of 0.25 in. (6 mm) apart. Mounting of bus bars in the horizontal plane will necessitate additional drafting. Edgewise orientation of the bus may change the maximum ratings indicated. If additional information is required for other connections of cable or bus, contact Siemens for information.

Application Recommendations

It is recommended that temperatures be measured on the line and load terminals or T-connectors of the center pole. These are usually the hottest terminals with a balanced load. A maximum temperature of 75°C (35°C over a maximum ambient of 40°C) would verify the particular application. Temperature profiles taken on these breakers can be correlated to ensure that the hottest points within the breaker are within the required temperature limits.

Interrupting Rating

Circuit breakers used in 400 Hz systems are limited to a 5000 A interrupting rating. If higher ratings are required, consult Siemens.

Breaker type	Maximum continuous ampere rating at 40°C (104°F)②			75°C (167F) Copper cable per pole	
	60HZ		Enclosed after derating	No of pieces	Wire size
	Open air	Open air③			
DG	50	48	38	1	#8
	60	57	46	1	#6
	70	63	50	1	#4
	80	72	58	1	#4
	90	80	64	1	#3
	100	90	72	1	#3
	110	95	75	1	#2
	125	105	84	1	#1
	150	125	100	1	#1/0
FG	100	90	72	1	#3
	110	95	75	1	#2
	125	105	84	1	#1
	150	125	100	1	#1/0
	175	140	112	1	#2/0
	200	160	128	1	#3/0
	225	180	144	1	#4/0
	250	200	160	1	250 kcmil
	250	210	168	1	250 kcmil
JG	300	240	192	1	350 kcmil
	350	260	208	1	500 kcmil
	400	300	240	2	#2/0
	400	300	240	2	#2/0
JG 100% Rated	250	210	210	1	250 kcmil
	300	240	240	1	350 kcmil
	350	260	260	1	500 kcmil
	400	300	300	2	#3/0
LG	400	300	240	2	#3/0
	500	375	300	2	250 kcmil
	600	420	336	2	350 kcmil

Breaker type	Maximum continuous ampere rating at 40°C (104°F)②			75°C (167F) Copper cable per pole	
	60HZ		Enclosed after derating	No of pieces	Wire size
	Open air	Open air③			
LG	400	300	240	2	#3/0
	500	375	300	2	250 kcmil
	600	420	336	2	350 kcmil
MG	600	430	360	2	350 kcmil
	700	500	400	3	250 kcmil
	800	560	448	3	300 kcmil
MG 100% Rated	600	430	430	2	350 kcmil
	700	500	500	3	250 kcmil
	800	560	560	3	300 kcmil
NG	800	560	448	3	300 kcmil
	900	600	480	3	350 kcmil
	1000	650	520	3	400 kcmil
	1200	780	624	4	350 kcmil
NG 100% Rated	900	600	600	3	350 kcmil
	1000	650	650	3	400 kcmil
	1200	780	780	4	350 kcmil
	1200	780	624	4	400 kcmil
PG	1400	850	680	4	500 kcmil
	1600	960	768	5	500 kcmil
	1200	780	780	4	400 kcmil
PG 100% Rated	1400	850	850	4	500 kcmil
	1600	960	960	5	500 kcmil

① The information provided on this page is intended for reference and recommendation only. Because several variables can act on a circuit breaker's performance at the same time, the data above is based less on controlled testing, than on experience and engineering

judgment. Contact Siemens for further information on special conditions and treatment.

② Additional derating may be required if the ambient temperature is greater than 40°C (104°F).

③ Calculated after derating to compensate for the heating of the copper conductor, caused by the skin effect generated by eddy currents produced at 400/415HZ.

Molded Case Circuit Breakers

Series Connected Short Circuit Ratings

General

The term "Series Connected Short Circuit Rating" refers to the application of series circuit breakers in a combination that allows downstream breakers to have lower individual interrupting ratings than the available fault current.

This is permitted as long as the series combination has been tested and certified by UL.

The tables on these pages list specific main and branch breaker combinations that may be used for the short circuit interrupting ratings shown.

No substitutions are permitted. All combinations shown have been tested and are UL Listed. This information is provided as a reference tool only. **For verification of specific combination ratings consult the UL Recognized Components Directory.**

240V Breaker Series Ratings

Series Rating kAIR	Main Breaker		Branch Breaker				
	Type	Max. Amperes	Type	Number of Poles	Voltage	Amperes	
22000	QPH, BQH, BLH	70 (1P) 125 (2P) 100 (3P)	QP, BQ, BL	1	120/240	15-70	
				2	240	15-125	
				3	240	15-100	
			QE, BLE, QPF, BLF	2	120/240	15-60	
			QE, BLE, BE, QPF, BQF, BLF QPF2, BLF2	1	240	15-30	
			QT	1, 2	120/240	15-40	
			QG, BG, BLG	1, 2	120/240	15-30	
			BAF, QAF, QAF2, BAF2, QFGA2, BFGA2	1	120	15-20	
			BAF, QAF	2	120/240	15-20	
			QPMH	200 (2P)	QP	1	120
		2	120/240		35-70		
			2		120/240	15-25	
			2		120/240	35-125	
	QE, QPF	1	120/240		15-30		
		2	120/240		15-60		
			1	120	15-20		
			2	120/240	15-20		
			2	120/240	15-30		
	QJH2	225 (2P, 3P)	QP, BQ, BL	1	120/240	15-70	
			2	240	15-125		
			3	240	60-100		
	QPF, BQF, BLF, BG, BLG		1	120	15-30		
	QE, BE, BLE, QPF2, BLF2		1	120	15-30		
	QPF, BLF, BG, BLG, QE, BE, BLE		2	120/240	15-60		
	BAF, QAF, QAF2, BAF2		1	120	15-20		
	BAF, QAF		2	120/240	15-20		
	QT		1, 2	120/240	15, 20, 40		
	QR2		2, 3	240	100-225		
	QPPH	225 (2P)	QP, BQ, BL	1	120/240	15-70	
			2	120/240	15-125		
	QE, BLE, BE, QPF, BQF, BLF, QPF2, BLF2		1	120	15-30		
	QE, BLE, BE, QPF, BLF		2	120/240	15-60		
	BAF, QAF, QAF2, BAF2		1	120	15-20		
	BAF, QAF		2	120/240	15-20		
	QPP		2	120/240	125-200		
	QT		1, 2	120/240	15-40		
	QRH2		250 (2, 3P)	QP, BQ, BL	1	120/240	15-70
				2	120/240	15-125	
		3		240	15-125		
		3		240	15-100		
	QG, BG, BLG	1		120	15-30		
		2		120/240	15-30		
	QT	1, 2		120/240	15-50		
	QFGA2, BFGA2, QAF2, BAF2, QAF, BAF	1		120	15-20		
	QAF, BAF	2		120/240	15-20		
QPF2, BLF2, QPF, BQF, BLF, QE, BLE, BE	1	120		15-30			
QPF, BLF, QE, BLE	2	120/240	15-60				
QN, QNR	2	120/240	150-200				
QS	2	120/240	100-225				
QR2	2	120/240	100-250				
42000	QJ2H	225 (2, 3P)	QP, BQ, BL	1	120/240	15-70	
			2	120/240	15-125		
			3	240	60-100		
QPH, BQH, BLH			1	120/240	15-70		
			2	120/240	15-125		
			3	240	15-100		
			2, 3	240	100-225		
			2, 3	240	60-225		
65000	HQP, HBO, HBL	70 (1P) 125 (2P) 100 (3P)	QP, BQ, BL	1	120/240	15-70	
				2	240	15-125	
				3	240	15-100	
			QPF, BQF, BLF, BE, QPHF, BQHF, BLHF, QEH, BLEH, QE, BLE, QPF2, BLF2, QPHF2, BLHF2, QPHF2, BLHF2	1	120	15-30	
			QEH, BLEH, QE, QPHF, BLHF, BLE, QPF, BLF	2	120/240	15-60	
			QT	1, 2	120/240	15-40	
			QG, BG, BLG	1, 2	120/240	15-30	

240V Breaker Series Ratings (continued)

Series Rating kAIR	Main Breaker		Branch Breaker					
	Type	Max. Amperes	Type	Number of Poles	Voltage	Amperes		
65000 (cont.)	HQP, HBO, HBL	70 (1P) 125 (2P) 100 (3P)	BAF, QAF, BOAF, QAF2, BAF2, QAFH2, BAFH2, QFGA2, BFGA2, QF-GAH2, BFGAH2	1	120	15-20		
			BAF, QAF	2	120/240	15-20		
			QP, BQ, BL	1	120/240	15-70		
	ED4, ED4, ED6	100 (1P) 125 (2P, 3P)	QPH, BQH, BLH	2	240	15-125		
				3	240	15-100		
			QPHF, BQHF, BLHF, QPF, BQF, BLF, QE, QEH, BLEH, BE, BLE, QPF2, BLF2, QPHF2, BLHF2	1	120	15-30		
			QEH, BLEH, QE, QPHF, BLHF, BLE, QPF, BLF	2	120/240	15-60		
			QAF2, BAF2, BAF, QAF, BOAF, QAFH2, BAFH2, QAFH, BOAFH, BAFH, QFGA2, BFGA2, QF-GAH2, BFGAH2	1	120	15-20		
			QAF, BAF, QAFH, BAFH	2	120/240	15-20		
			ED2	1, 2, 3	120/240	15-100		
			QT	1, 2	120/240	15-40		
			NDGA, NDGB	150 (2P, 3P)	QPH, BQH, BLH	1	120/240	15-70
				2	240	15-125		
		3	240	15-100				
	HQPP	225 (2P)	QP, BQ, BL	1	120/240	15-70		
			QPH, BQH, BLH	2	120/240	15-125		
			QPF, BQF, BLF, QPHF, BQHF, BLHF, QEH, BLEH, QE, BLE, BE, BLF2, QPF2, QFGA2, BFGA2	1	120/240	15-30		
			QEH, BLEH, QE, QPHF, BLHF, BLE, QPF, BLF	2	120/240	15-60		
			BAF, QAF, BOAF, QAF2, BAF2, QAFH2, BAFH2, QAFH, BOAFH, QFGAH2, BFGAH2	1	120	15-20		
			BAF, QAF, QAFH, BAFH	2	120/240	15-20		
			QT	1, 2	120	15-40		
			QPPH, QPP	2	120/240	125-200		
			FD6-A, FXD6-A	250 (2P, 3P)	QP, BQ, BL	1	120/240	15-70
					QPH, BQH, BLH	2	120/240	15-125
		3			240	15-100		
	QPF, QPHF, BLF, BLHF	1, 2			120/240	15-60		
	QPF2, BLF2, QPHF2, BLHF2	1			120	15-30		
		2			120/240	15-60		
	QAF, BAF, QAF2, BAF2, BOAF, QAFH2, BAFH2, QAFH, BOAFH, BAFH, QFGA2, BFGA2, QF-GAH2, BFGAH2	1			120	15-20		
	QAF, BAF, QAFH, BAFH	2			120/240	15-20		
	QR2, QRH2	2, 3			240	100-225		
	QJ2H, QJ2, QJH2	2, 3			240	60-225		
	QPPH	2	120/240	125-225				
	NFGA, NFGB	250 (2P, 3P)	QPH, BQH, BLH	1	120/240	15-70		
				2	120/240	15-125		
				3	240	15-100		
				2, 3	240	100-250		
	HQR2	250 (2P, 3P)	QP, BQ, BL	1	120/240	15-70		
				2	120/240	15-125		
				3	240	15-100		
			QT	1, 2	120/240	15-50		
			QFGA2, BFGA2, QAF2, BAF2, QAF, BAF	1	120	15-20		
			QAF, BAF	2	120/240	15-20		
			QPF2, BLF2, QPF, BQF, BLF, QE, BLE, BE	1	120	15-30		
			QPF, BLF, QE, BLE	2	120/240	15-60		
QPH, BQH, BLH			1	120/240	15-70			
			2	120/240	15-125			
	3	240	15-100					

Molded Case Circuit Breakers

Series Connected Short Circuit Ratings

General

240V Breaker Series Ratings (continued)

Series Rating kAIR	Main Breaker		Branch Breaker					
	Type	Max. Amperes	Type	Number of Poles	Voltage	Amperes		
65000 (cont.)	HQR2 (cont.)	250 (2P, 3P)	QFGAH2, BFGAH2, QAFH2, BAFH2, QAFH, BAFH	1	120	15-20		
			QAFH, BAFH	2	120/240	15-20		
			QPHF, BLHF, QPHF2, BLHF2, QEH, BLEH	1	120	15-30		
			QEH, BLEH, QPHF, BLHF	2	120/240	15-60		
			QN, QNH, QNR, QNRH	2	120/240	150-200		
			QS, QSH, QSHH	2	120/240	100-225		
			QR2, QRH2	2,3	240	100-250		
	JXD2-A, JD6-A, JXD6-A	400 (2P, 3P)	QPH, BQH, BLH	1	120/240	15-70		
				2	120/240	15-125		
				3	240	15-100		
			QAF2, BAF2, QAFH2, BAFH2, QFGA2, BFGA2, QFGAH2, BFGAH2	1	120	15-20		
			QPF2, BLF2, QPHF2, BLHF2	1	120	15-30		
			QR2, QRH2	2,3	240	100-250		
			QJ2H, QJH2	2,3	240	60-225		
			NJGA, NJJA	400 (2P, 3P)	QPH, BQH, BLH	1	120/240	15-70
						2	120/240	15-125
						3	240	15-100
	QR2, QRH2	2,3			240	100-250		
	QN, QNH	2			120/240	150-200		
	QNR, QNRH	2			120/240	150-200		
	SJD6-A, SJD6-B	400 (2P, 3P)	QPH, BQH, BLH	1	120/240	15-70		
				2	120/240	15-125		
				3	240	15-100		
			QAF2, BAF2, QAFH2, BAFH2, QFGA2, BFGA2, QFGAH2, BFGAH2	1	120	15-20		
			QPF2, BLF2, QPHF2, BLHF2	1	120	15-30		
	HJD6-A, HJXD6	400 (2P, 3P)	QR2, QRH2	2,3	240	100-250		
			QPH	1	120/240	15-70		
				2	120/240	15-125		
				3	240	15-100		
			QAF2, BAF2, QAFH2, BAFH2, QFGA2, BFGA2, QFGAH2, BFGAH2	1	120	15-20		
	LD6-A, LXD6-A	600 (2P, 3P)	QPF2, BLF2, QPHF2, BLHF2	1	120	15-30		
			QR2, QRH2	2,3	240	100-250		
			QPH, BQH, BLH	1	120/240	15-70		
				2	120/240	15-125		
				3	240	15-100		
			QAF2, BAF2, QAFH2, BAFH2, QFGA2, BFGA2, QFGAH2, BFGAH2	1	120	15-20		
			QPF2, BLF2, QPHF2, BLHF2	1	120	15-30		
			QJ2H, QJH2	2,3	240	60-225		
			NLGA, NLGB	600 (2P, 3P)	QPH, BQH, BLH	1	120/240	15-70
						2	120/240	15-125
		3			240	15-100		
	QR2, QRH2	2,3			240	100-250		
	QAF2, BAF2, QAFH2, BAFH2, QFGA2, BFGA2, QFGAH2, BFGAH2	1			120	15-20		
	QPF2, BLF2, QPHF2, BLHF2	1			120	15-30		
	SLD6-A, SLD6-B	600 (2P, 3P)	QN, QNH	2	120/240	150-200		
			QNR, QNRH	2	120/240	150-200		
			QPH, BQH, BLH	1	120/240	15-70		
				2	120/240	15-125		
				3	240	15-100		
			QAF2, BAF2, QAFH2, BAFH2, QFGA2, BFGA2, QFGAH2, BFGAH2	1	120	15-20		
	HLD6-A, HLD6-A	600 (2P, 3P)	QPF2, BLF2, QPHF2, BLHF2	1	120	15-30		
			QR2, QRH2	2,3	240	100-250		
			QPH	1	120/240	15-70		
				2	120/240	15-125		
				3	240	15-100		
			QAF2, BAF2, QAFH2, BAFH2, QFGA2, BFGA2, QFGAH2, BFGAH2	1	120	15-20		
	MD6, MXD6	800 (2P, 3P)	QPF2, BLF2, QPHF2, BLHF2	1	120	15-30		
			QR2, QRH2	2,3	240	100-250		
			QPH, BQH, BLH	1	120/240	15-70		
				2	120/240	15-125		
				3	240	15-100		
			QAF2, BAF2, QAFH2, BAFH2, QFGA2, BFGA2, QFGAH2, BFGAH2	1	120	15-20		

240V Breaker Series Ratings (continued)

Series Rating kAIR	Main Breaker		Branch Breaker					
	Type	Max. Amperes	Type	Number of Poles	Voltage	Amperes		
65000 (cont.)	NMG, HMG	800 (2P, 3P) (cont.)	QPH, BQH, BLH	1	120/240	15-70		
				2	120/240	15-125		
				3	240	15-100		
			QAF2, BAF2, QAFH2, BAFH2, QFGA2, BFGA2, QFGAH2, BFGAH2	1	120	15-20		
			QPF2, BLF2, QPHF2, BLHF2	1	120	15-30		
			QR2, QRH2	2,3	240	100-250		
			QN, QNH	2	120/240	150-200		
			QNR, QNRH	2	120/240	150-200		
			SMD6, SMD6-B	800 (2P, 3P) (cont.)	QPH, BQH, BLH	1	120/240	15-70
						2	120/240	15-125
		3			240	15-100		
	QAF2, BAF2, QAFH2, BAFH2, QFGA2, BFGA2, QFGAH2, BFGAH2	1			120	15-20		
	QPF2, BLF2, QPHF2, BLHF2	1			120	15-30		
	QR2, QRH2	2,3			240	100-250		
	HMXD6, HMD6	800 (2P, 3P) (cont.)	QPH	1	120/240	15-70		
				2	120/240	15-125		
				3	240	15-100		
			QAF2, BAF2, QAFH2, BAFH2, QFGA2, BFGA2, QFGAH2, BFGAH2	1	120	15-20		
			QPF2, BLF2, QPHF2, BLHF2	1	120	15-30		
			QR2, QRH2	2,3	240	100-250		
	ND6, NXD	1200 (2P, 3P)	QPH, BQH, BLH	1	120/240	15-70		
				2	120/240	15-125		
				3	240	15-100		
			QAF2, BAF2, QAFH2, BAFH2, QFGA2, BFGA2, QFGAH2, BFGAH2	1	120	15-20		
			QPF2, BLF2, QPHF2, BLHF2	1	120	15-30		
			QR2, QRH2	2,3	240	100-250		
	NNG, HNG	1200 (2P, 3P)	QPH, BQH, BLH	1	120/240	15-70		
				2	120/240	15-125		
				3	240	15-100		
			QAF2, BAF2, QAFH2, BAFH2, QFGA2, BFGA2, QFGAH2, BFGAH2	1	120	15-20		
			QPF2, BLF2, QPHF2, BLHF2	1	120	15-30		
			QR2, QRH2	2,3	240	100-250		
	SND6, SND6-B	1600 (2P, 3P)	QN, QNH	2	120/240	150-200		
			QNR, QNRH	2	120/240	150-200		
			QPH, BQH, BLH	1	120/240	15-70		
				2	120/240	15-125		
				3	240	15-100		
			QAF2, BAF2, QAFH2, BAFH2, QFGA2, BFGA2, QFGAH2, BFGAH2	1	120	15-20		
	HND6, HNXD6	1600 (2P, 3P)	QPF2, BLF2, QPHF2, BLHF2	1	120	15-30		
			QR2, QRH2	2,3	240	100-250		
			QPH	1	120/240	15-70		
				2	120/240	15-125		
				3	240	15-100		
			QAF2, BAF2, QAFH2, BAFH2, QFGA2, BFGA2, QFGAH2, BFGAH2	1	120	15-20		
	SPD6, SPD6-B, PD6, PXD6	1600 (2P, 3P)	QPH, BQH, BLH	1	120/240	15-70		
				2	120/240	15-125		
				3	240	15-100		
			QR2, QRH2	2,3	240	100-250		
			QPH, BQH, BLH	1	120/240	15-70		
				2	120/240	15-125		
	NPG	1600 (2P, 3P)		3	240	15-100		
			QR2, QRH2	2,3	240	100-250		
			QN, QNH	2	120/240	150-200		
			QNR, QNRH	2	120/240	150-200		
			QPH	1	120/240	15-70		
				2	120/240	15-125		
	HPD6, HPXD6	1600 (2P, 3P)		3	240	15-100		
			QPH	1	120/240	15-70		
				2	120/240	15-125		
				3	240	15-100		
			QPH	1	120/240	15-70		
				2	120/240	15-125		
	HRD6, HRXD6	2000 (2P, 3P)		3	240	15-100		
			QPH	1	120/240	15-70		
				2	120/240	15-125		
				3	240	15-100		
			QR2, QRH2	2,3	240	100-250		
			QPH, BQH, BLH	1	120/240	15-70		
	RD6, RXD6	2000 (2P, 3P)		2	120/240	15-125		
				3	240	15-100		
			QPH, BQH, BLH	1	120/240	15-70		
				2	120/240	15-125		
				3	240	15-100		
			QPH, BQH, BLH	1	120/240	15-70		

7 MOLDED CASE CIRCUIT BREAKERS

Molded Case Circuit Breakers

Series Connected Short Circuit Ratings

General

240V Breaker Series Ratings (continued)

Series Rating kAIR	Main Breaker		Branch Breaker						
	Type	Max. Amperes	Type	Number of Poles	Voltage	Amperes			
100000	HED4, HED6	100 (1P)	ED2, ED4	1	120	15-100			
			QP, BQ, BL, OPH, BOH, BLH, HQP, HBO, HBL	1	120/240	15-70			
				2	240	15-125			
				3	240	15-100			
			QAF2, BAF2, QAF, BQAF, BAF, QAFH2, BAFH2, HQAF2, HBAF2, QAFH, BOAFH, BAFH, QFGA2, BFGA2, HQFGA2, HBF-GA2, QFGAH2, BFGAH2	1	120	15-20			
			QAF, BAF, QAFH, BAFH	2	120/240	15-20			
			QEH, BLEH, QE, BE, QPHF, BQHF, BLHF, QPF, BLF, BQF, BLE, QPF2, BLF2, QPHF2, BLHF2, HQPF2, HBLF2	1	120	15-30			
			QEH, BLEH, QPHF, QE, BLHF, QPF, BLF, BLE	2	120/240	15-60			
			ED2	1,2,3	120/240	15-100			
			ED4	1	120	15-100			
			ED4, ED6	2,3	240	15-125			
			QT	1,2	120/240	15-40			
			NGB, HGB, LBG			QAF2, QAFH2, QAF, BQAF, BAF, BAFH2, HQAF2, HBAF2, QAFH, BOAFH, BAFH, QFGA2, BFGA2, HQFGA2, HBF-GA2, QFGAH2, BFGAH2	1	120	15-20
						QAF, BAF, QAFH, BAFH	2	120/240	15-20
						QPF, BQF, BLF, QPHF, BQHF, BLHF, QPF2, BLF2, QPHF2, BLHF2, HQPF2, HBLF2	1	120	15-30
	QPF, BLF	2				120/240	15-60		
	QP, BQ, BL, OPH, BQH, BLH, HQP, HBO, HBL	1				120	15-70		
		2				120/240	15-125		
	NGB, HGB, LBG				3	240	15-100		
				ED4, ED6	1	240	15-100		
				ED4, ED6	2,3	240	15-125		
	HDGA, HDGB	150 (2P, 3P)		NDGA, NDGB	2,3	240	50-150		
				QP, BO, BL, OPH, BQH, BLH, HQP, HBO, HBL	1	120/240	15-70		
					2	120/240	15-125		
	HQPPH	225 (2P)		HQPP, QPPH, QPP	2	120/240	125-225		
				QAF2, BAF2, QAF, BQAF, BAF, QAFH2, BAFH2, HQAF2, HBAF2, QAFH, BOAFH, BAFH, QFGA2, BFGA2, HQFGA2, HBF-GA2, QFGAH2, BFGAH2	1	120	15-20		
				QAF, BAF, QAFH, BAFH	2	120/240	15-20		
				QEH, BLEH, QE, BE, QPHF, BQHF, BLHF, QPF, BQF, BLF, BLE, QPF2, BLF2, QPHF2, BLHF2, HQPF2, HBLF2	1	120	15-30		
				QE, QEH, BLEH, QPHF, BLHF, QPF, BLF, BLE	2	120/240	15-60		
				QR2, QRH2, HQR2	2	120/240	100-225		
QR2, QRH2, HQR2				2	120/240	100-225			
QT				1,2	120/240	15-40			
QP, BP, QL				1	120/240	15-25			
				2	120/240	35-70			
				3	240	15-100			
				2,3	240	100-225			
QPH, BQH, BLH, HQP, HBO, HBL				1	120/240	15-70			
				2	120/240	15-125			
				3	240	15-100			
HJQ2H	225 (2P, 3P)		QAF2, BAF2, QAF, BQAF, BAF, QAFH2, BAFH2, HQAF2, HBAF2, QAFH, BOAFH, BAFH, QFGA2, BFGA2, HQFGA2, HBF-GA2, QFGAH2, BFGAH2	1	120	15-20			
			QAF, BAF, QAFH, BAFH	2	120/240	15-20			
			QEH, BLEH, QE, BE, QPHF, BQHF, BLHF, QPF, BQF, BLF, BLE, QPF2, BLF2, HQPF2, HBLF2, QPHF2, BLHF2	1	120	15-30			
			QEH, BLEH, QPHF, BLE, BLHF, QE, QPF, BLF	2	120/240	15-60			
			QT	1	120/240	15-50			
				2	120/240	15-25			
				3	240	15-100			
			QR2, QRH2, HQR2	2,3	240	100-225			
			QPH, BQH, BLH, HQP, HBO, HBL	1	120/240	15-70			
				2	120/240	15-125			

240V Breaker Series Ratings (continued)

Series Rating kAIR	Main Breaker		Branch Breaker				
	Type	Max. Amperes	Type	Number of Poles	Voltage	Amperes	
100000 (cont.)	HFD6, HFXD6		QP, BQ, BL, OPH, BOH, BLH, HQP, HBO, HBL	1	120/240	15-70	
				2	120/240	15-125	
				3	240	15-100	
			QAF2, BAF2, QAF, BQAF, BAF, QAFH2, BAFH2, HQAF2, HBAF2, QAFH, BOAFH, BAFH, QFGA2, BFGA2, HQFGA2, HBF-GA2, QFGAH2, BFGAH2	1	120	15-20	
			QAF, BAF, QAFH, BAFH	2	120/240	15-20	
			QE, BE, BLE, OPHF, BQHF, BLHF, QPF, BQF, BLF, QEH, BLEH, QPF2, BLF2, HQPF2, HBLF2, QPHF2, BLHF2	1	120	15-30	
			QPF, BLF, BLE, BLEH, QPHF, BLHF, QEH, QE	2	120/240	15-60	
			ED4	1	120	15-100	
			ED4, ED6	2,3	240	15-125	
			FD6-A, FXD6-A	2,3	240	70-250	
			QJ2, QJH2, QJ2H	2,3	240	60-225	
			HQPP, QPPH, QPP	2	120/240	125-225	
			QR2, QRH2, HQR2	2,3	240	100-250	
			QT	1,2	120/240	15-40	
			HFGA, HFGB	250 (2P, 3P)		NDGA, NDGB	2, 3
	NFGA, NFGB	2, 3				240	70-250
	ED4, ED6	1				240	15-100
	ED4, ED6	2,3				240	15-125
	NFGA, NFGB	2, 3				240	70-250
	QAF2, BAF2, QAFH2, BAFH2, HQAF2, HBAF2, QFGA2, BFGA2, HQFGA2, HBF-GA2, QFGAH2, BFGAH2	1				120	15-20
	QPF2, BLF2, HQPF2, HBLF2, QPHF2, BLHF2	1				120	15-30
	QR2, QRH2, HQR2	2,3				240	100-250
	FD6, FXD6	2, 3				240	70-250
	FD6-A, FXD6-A	2, 3				240	70-250
	HQR2H			QP, BQ, BL	1	120/240	15-70
					2	120/240	15-125
					3	240	15-100
				QT	1,2	120/240	15-50
				QFGA2, BFGA2, QAF2, BAF2, QAF, BAF	1	120	15-20
				QAF, BAF	2	120/240	15-20
				QPF2, BLF2, QPF, BQF, BLF, QE, BLE, BE	1	120	15-30
				QPF, BLF, QE, BLE	2	120/240	15-60
				QPH, BQH, BLH	1	120/240	15-70
					2	120/240	15-125
					3	240	15-100
				QFGAH2, BFGAH2, QAFH2, BAFH2, HQFGA2, HBF-GA2, HQAF2, HBAF2, QAFH, BAFH	1	120	15-20
				QAFH, BAFH	2	120/240	15-20
				QPHF, BLHF, QPHF2, BLHF2, QEH, BLEH, HQPF2, HBLF2	1	120	15-30
				QEH, BLEH, QPHF, BLHF	2	120/240	15-60
	HQP, HBO, HBL	1	120/240	15-70			
		2	120/240	15-125			
		3	240	15-100			
	OS, OSH, QSHH, HOS	2	120/240	100-225			
	QR2, QRH2, HQR2	2,3	240	100-250			
	HJD6-A, HJXD6-A	400 (2P, 3P)		ED4	1	120	15-100
ED4, ED6				2, 3	240	15-125	
QAF2, BAF2, QAFH2, BAFH2, HQAF2, HBAF2, QFGA2, BFGA2, HQFGA2, HBF-GA2, QFGAH2, BFGAH2				1	120	15-20	
QPF2, BLF2, HQPF2, HBLF2, QPHF2, BLHF2				1	120	15-30	
QR2, QRH2, HQR2				2,3	240	100-250	
FD6-A, FXD6-A				2, 3	240	70-250	
JD6-A, JXD6-A				2, 3	240	200-400	
JXD2-A, SJD6-A				2, 3	240	200-400	
NDGA, NDGB				2, 3	240	50-150	
NFGA, NFGB				2, 3	240	70-250	
NJGA, NJJA	2, 3	240	200-400				

Molded Case Circuit Breakers

Series Connected Short Circuit Ratings

General

240V Breaker Series Ratings (continued)

Series Rating kAIR	Main Breaker		Branch Breaker			
	Type	Max. Amperes	Type	Number of Poles	Voltage	Amperes
100000 (cont.)	HJGA	400 (2P, 3P)	ED4, ED6	1	240	15-100
			ED4, ED6	2,3	240	15-125
			QAF2, BAF2, QAFH2, BAFH2, HQAF2, HBAF2, QFGA2, BFGA2 HQFGA2, HBFGA2, QFGAH2, BFGAH2	1	120	15-20
			QPF2, BLF2, HQPF2, HBLF2, QPHF2, BLHF2	1	120	15-30
			NFGA, NFGB	2, 3	240	70-250
			FD6, FXD6	2, 3	240	70-250
			FD6-A, FXD6-A	2, 3	240	70-250
			QR2, QRH2, HQR2	2, 3	240	100-250
			NJGA, NJJA	2, 3	240	200-400
			JD6, JXD6	2, 3	240	200-400
			JD6-A, JXD6-A	2, 3	240	200-400
			ED4	1	120	15-100
			ED4, ED6	2, 3	240	15-125
			FD6-A, FXD6-A	2, 3	240	70-250
			JD6-A, JXD6-A	2, 3	240	200-400
			JXD2-A, SJD6-A, SJD6-B	2, 3	240	200-400
			QAF2, BAF2, QAFH2, BAFH2, HQAF2, HBAF2, QFGA2, BFGA2 HQFGA2, HBFGA2, QFGAH2, BFGAH2	1	120	15-20
			QPF2, BLF2, HQPF2, HBLF2, QPHF2, BLHF2	1	120	15-30
			QR2, QRH2, HQR2	2, 3	240	100-250
			NDGA, NDGB	2, 3	240	50-150
	NFGA, NFGB	2, 3	240	70-250		
	NJGA, NJJA	2, 3	240	200-400		
	ED4	1	120	15-100		
	ED4, ED6	2, 3	240	15-125		
	QAF2, BAF2, QAFH2, BAFH2, HQAF2, HBAF2, QFGA2, BFGA2 HQFGA2, HBFGA2, QFGAH2, BFGAH2	1	120	15-20		
	QPF2, BLF2, HQPF2, HBLF2, QPHF2, BLHF2	1	120	15-30		
	FD6-A, FXD6-A	2, 3	240	70-250		
	JD6-A, JXD6-A, JXD2-A, SJD6-A, SJD6-B	2, 3	240	200-400		
	LD6-A	2, 3	240	200-600		
	LXD6-A	2, 3	240	450-600		
	SLD6-A, SLD6-B	3	240	300-600		
	QR2, QRH2, HQR2	2, 3	240	100-250		
	NDGA, NDGB	2, 3	240	50-150		
	NFGA, NFGB	2, 3	240	70-250		
	NJGA, NJJA	2, 3	240	200-400		
	NLGA, NLGB	2, 3	240	400-600		
	ED4, ED6	1	240	15-100		
	ED4, ED6	2, 3	240	15-125		
	NFGA, NFGB	2, 3	240	70-250		
	FD6, FXD6	2, 3	240	70-250		
	FD6-A, FXD6-A	2, 3	240	70-250		
	NJGA, NJJA	2, 3	240	200-400		
	JD6, JXD6	2, 3	240	200-400		
	JD6-A, JXD6-A	2, 3	240	200-400		
	NLGA, NLGB	2, 3	240	400-600		
	QAF2, BAF2, QAFH2, BAFH2, HQAF2, HBAF2, QFGA2, BFGA2 HQFGA2, HBFGA2, QFGAH2, BFGAH2	1	120	15-20		
	QPF2, BLF2, HQPF2, HBLF2, QPHF2, BLHF2	1	120	15-30		
	QR2, QRH2, HQR2	2, 3	240	100-250		
	LD6, LD6-A	2, 3	240	200-600		
	LXD6, LXD6-A	2, 3	240	450-600		
	ED4	1	120	15-100		
	ED4, ED6	2, 3	240	15-125		
	FD6-A, FXD6-A	2, 3	240	70-250		
	JD6-A, JXD6-A, JXD2-A, SJD6-A, SJD6-B	2, 3	240	200-400		
	LD6-A	2, 3	240	200-600		
	LXD6-A	2, 3	240	450-600		
	SLD6-A, SLD6-B	3	240	300-600		
	QAF2, BAF2, QAFH2, BAFH2, HQAF2, HBAF2, QFGA2, BFGA2 HQFGA2, HBFGA2, QFGAH2, BFGAH2	1	120	15-20		
	QPF2, BLF2, HQPF2, HBLF2, QPHF2, BLHF2	1	120	15-30		
	QR2, QRH2, HQR2	2, 3	240	100-250		
	LD6, LD6-A	2, 3	240	200-600		
	LXD6, LXD6-A	2, 3	240	450-600		
	ED4	1	120	15-100		
	ED4, ED6	2, 3	240	15-125		
	FD6-A, FXD6-A	2, 3	240	70-250		
	JD6-A, JXD6-A, JXD2-A, SJD6-A, SJD6-B	2, 3	240	200-400		
	LD6-A	2, 3	240	200-600		
	LXD6-A	2, 3	240	450-600		
	SLD6-A, SLD6-B	3	240	300-600		
	QAF2, BAF2, QAFH2, BAFH2, HQAF2, HBAF2, QFGA2, BFGA2 HQFGA2, HBFGA2, QFGAH2, BFGAH2	1	120	15-20		
	QPF2, BLF2, HQPF2, HBLF2, QPHF2, BLHF2	1	120	15-30		
	QR2, QRH2, HQR2	2, 3	240	100-250		
	LD6, LD6-A	2, 3	240	200-600		
	LXD6, LXD6-A	2, 3	240	450-600		

240V Breaker Series Ratings (continued)

Series Rating kAIR	Main Breaker		Branch Breaker			
	Type	Max. Amperes	Type	Number of Poles	Voltage	Amperes
100000 (cont.)	SHLD6, SHLD6-A, SHLD6-B (cont.)	600 (3P) (cont.)	QR2, QRH2, HQR2	2, 3	240	100-250
			NDGA, NDGB	2, 3	240	50-150
			NFGA, NFGB	2, 3	240	70-250
			NJGA, NJJA	2, 3	240	200-400
			NLGA, NLGB	2, 3	240	400-600
			ED4, ED6	1	240	15-100
			ED4, ED6	2, 3	240	15-125
			NFGA, NFGB	2, 3	240	70-250
			FD6, FXD6	2, 3	240	70-250
			FD6-A, FXD6-A	2, 3	240	70-250
			NJGA, NJJA	2, 3	240	200-400
			JD6, JXD6	2, 3	240	200-400
			JD6-A, JXD6-A	2, 3	240	200-400
			NLGA, NLGB	2, 3	240	400-600
			LD6, LD6-A	2, 3	240	200-600
			LXD6, LXD6-A	2, 3	240	450-600
			NMG	2, 3	240	600-800
			QAF2, BAF2, QAFH2, BAFH2, HQAF2, HBAF2, QFGA2, BFGA2 HQFGA2, HBFGA2, QFGAH2, BFGAH2	1	120	15-20
			QPF2, BLF2, HQPF2, HBLF2, QPHF2, BLHF2	1	120	15-30
			QR2, QRH2, HQR2	2, 3	240	100-250
	LMD6, LMXD6	2, 3	240	600-800		
	MD6, MXD6	2, 3	240	400-800		
	NDGA, NDGB	2, 3	240	50-150		
	NFGA, NFGB	2, 3	240	70-250		
	NJGA, NJJA	2, 3	240	200-400		
	NLGA, NLGB	2, 3	240	400-600		
	NMG	2, 3	240	600-800		
	ED4	1	120	15-100		
	ED4, ED6	2, 3	240	15-125		
	FD6-A, FXD6-A	2, 3	240	70-250		
	JD6-A, JXD6-A, JXD2-A, SJD6-A	2, 3	240	200-400		
	LD6-A	2, 3	240	200-600		
	LXD6-A	2, 3	240	450-600		
	QAF2, BAF2, QAFH2, BAFH2, HQAF2, HBAF2, QFGA2, BFGA2 HQFGA2, HBFGA2, QFGAH2, BFGAH2	1	120	15-20		
	QPF2, BLF2, HQPF2, HBLF2, QPHF2, BLHF2	1	120	15-30		
	QR2, QRH2, HQR2	2, 3	240	100-250		
	SLD6-A, SLD6-B	3	240	300-600		
	MD6, MXD6	2, 3	240	500-800		
	SMD6, SMD6-B	3	240	600-800		
	NDGA, NDGB	2, 3	240	50-150		
	NFGA, NFGB	2, 3	240	70-250		
	NJGA, NJJA	2, 3	240	200-400		
	NLGA, NLGB	2, 3	240	400-600		
	NMG	2, 3	240	600-800		
	ED4	1	120	15-100		
	ED4, ED6	2, 3	240	15-125		
	FD6-A, FXD6-A	2, 3	240	70-250		
	JD6-A, JXD6-A, JXD2-A, SJD6-A, SJD6-B	2, 3	240	200-400		
	LD6-A	2, 3	240	200-600		
	LXD6-A	2, 3	240	450-600		
	QAF2, BAF2, QAFH2, BAFH2, HQAF2, HBAF2, QFGA2, BFGA2 HQFGA2, HBFGA2, QFGAH2, BFGAH2	1	120	15-20		
	QPF2, BLF2, HQPF2, HBLF2, QPHF2, BLHF2	1	120	15-30		
	QR2, QRH2, HQR2	2, 3	240	100-250		
	SLD6-A, SLD6-B	3	240	300-600		
	MD6, MXD6, SMD6, SMD6-B	2, 3	240	500-800		
	ED4, ED6	1	240	15-100		
	ED4, ED6	2, 3	240	15-125		
	FD6-A, FXD6-A	2, 3	240	70-250		
	JD6-A, JXD6-A, JXD2-A, SJD6-A, SJD6-B	2, 3	240	200-400		
	LD6-A	2, 3	240	200-600		
	LXD6-A	2, 3	240	450-600		
	QAF2, BAF2, QAFH2, BAFH2, HQAF2, HBAF2, QFGA2, BFGA2 HQFGA2, HBFGA2, QFGAH2, BFGAH2	1	120	15-20		
	QPF2, BLF2, HQPF2, HBLF2, QPHF2, BLHF2	1	120	15-30		
	QR2, QRH2, HQR2	2, 3	240	100-250		
	SLD6-A, SLD6-B	3	240	300-600		
	MD6, MXD6, SMD6, SMD6-B	2, 3	240	500-800		
	ED4, ED6	1	240	15-100		
	ED4, ED6	2, 3	240	15-125		
	NFGA, NFGB	2, 3	240	70-250		
	FD6, FXD6	2, 3	240	70-250		
	FD6-A, FXD6-A	2, 3	240	70-250		
	NJGA, NJJA	2, 3	240	200-400		
	JD6, JXD6	2, 3	240	200-400		
	JD6-A, JXD6-A	2, 3	240	200-400		
	NLGA, NLGB	2, 3	240	400-600		
	LD6, LD6-A	2, 3	240	200-600		
	LXD6, LXD6-A	2, 3	240	450-600		

MOLDED CASE CIRCUIT BREAKERS

Molded Case Circuit Breakers

Series Connected Short Circuit Ratings

General

240V Breaker Series Ratings (continued)

Series Rating kAIR	Main Breaker		Branch Breaker					
	Type	Max. Amperes	Type	Number of Poles	Voltage	Amperes		
100000 (cont.)	HNG (cont.)		QAF2, BAF2, QAFH2, BAFH2, HQAF2, HBAF2, QFGA2, BFGA2 HQFGA2, HBFGA2, QFGAH2, BFGAH2	1	120	15-20		
			QPF2, BLF2, HQPF2, HBLF2, QPHF2, BLHF2	1	120	15-30		
			QR2, QRH2, HQR2	2,3	240	100-250		
			NMG	2, 3	240	600-800		
			LMD6, LMXD6	2, 3	240	600-800		
			NNG	2, 3	240	800-1200		
			ND6, NXD6	2,3	240	600-1200		
			ED4	1	240	15-100		
			ED4, ED6	2,3	240	15-125		
			FD6-A, FXD6-A	2,3	240	70-250		
			JD6-A, JXD6-A, JXD2-A, SJD6-A	2,3	240	200-400		
			LD6-A	2,3	240	200-600		
			LXD6-A	2,3	240	450-600		
			SLD6-A, SLD6-B	3	240	300-600		
			MD6, MXD6, SMD6	2,3	240	500-800		
			ND6, NXD6, SND6, SND6-B	2,3	240	500-1200		
			HND6, HNXD6		QAF2, BAF2, QAFH2, BAFH2, HQAF2, HBAF2, QFGA2, BFGA2 HQFGA2, HBFGA2, QFGAH2, BFGAH2	1	120	15-20
					QPF2, BLF2, HQPF2, HBLF2, QPHF2, BLHF2	1	120	15-30
					QR2, QRH2, HQR2	2,3	240	100-250
					NDGA, NDGB	2, 3	240	50-150
	NFGA, NFGB	2, 3			240	70-250		
	NJGA, NJJA	2, 3			240	200-400		
	NLGA, NLGB	2, 3			240	400-600		
	NMG	2, 3			240	600-800		
	NNG	2, 3			240	800-1200		
	ED4	1			240	15-100		
	ED4, ED6	2,3			240	15-125		
	FD6-A, FXD6-A	2,3			240	70-250		
	JD6-A, JXD6-A, JXD2-A, SJD6-A	2,3			240	200-400		
	LD6-A	2,3			240	200-600		
	LXD6-A	2,3			240	450-600		
	SLD6-A, SLD6-B	3			240	300-600		
	MD6, MXD6, SMD6, SMD6-B	2,3			240	500-800		
	ND6, NXD6, SND6, SND6-B	2,3			240	500-1200		
	SHND6, SHND6-B				QAF2, BAF2, QAFH2, BAFH2, HQAF2, HBAF2, QFGA2, BFGA2 HQFGA2, HBFGA2, QFGAH2, BFGAH2	1	120	15-20
					QPF2, BLF2, HQPF2, HBLF2, QPHF2, BLHF2	1	120	15-30
			QR2, QRH2, HQR2	2,3	240	100-250		
			NDGA, NDGB	2, 3	240	50-150		
			NFGA, NFGB	2, 3	240	70-250		
			NJGA, NJJA	2, 3	240	200-400		
			NLGA, NLGB	2, 3	240	400-600		
			NMG	2, 3	240	600-800		
			NNG	2, 3	240	800-1200		
			ED4, ED6	1	240	15-100		
			ED4, ED6	2,3	240	15-125		
			NFGA, NFGB	2, 3	240	70-250		
			FD6, FXD6	2, 3	240	70-250		
			FD6-A, FXD6-A	2, 3	240	70-250		
			NJGA, NJJA	2, 3	240	200-400		
			JD6, JXD6	2, 3	240	200-400		
			JD6-A, JXD6-A	2, 3	240	200-400		
			NLGA, NLGB	2, 3	240	400-600		
			LD6, LD6-A	2, 3	240	200-600		
			LXD6, LXD6-A	2, 3	240	450-600		
	QR2, QRH2, HQR2	2,3	240	100-250				
	NMG	2, 3	240	600-800				
	LMD6, LMXD6	2, 3	240	600-800				
	MD6, MXD6	2, 3	240	400-800				
	NNG	2, 3	240	800-1200				
	ND6, NXD6	2, 3	240	600-1200				
	NPG	2, 3	240	1200-1600				
	PD6, PXD6	2, 3	240	1200-1600				
	HPG		ED4, ED6	1	240	15-100		
			ED4, ED6	2,3	240	15-125		
			NFGA, NFGB	2, 3	240	70-250		
			FD6, FXD6	2, 3	240	70-250		
			FD6-A, FXD6-A	2, 3	240	70-250		
			NJGA, NJJA	2, 3	240	200-400		
			JD6, JXD6	2, 3	240	200-400		
			JD6-A, JXD6-A	2, 3	240	200-400		
			NLGA, NLGB	2, 3	240	400-600		
			LD6, LD6-A	2, 3	240	200-600		
			LXD6, LXD6-A	2, 3	240	450-600		
			QR2, QRH2, HQR2	2,3	240	100-250		
			NMG	2, 3	240	600-800		
			LMD6, LMXD6	2, 3	240	600-800		
			MD6, MXD6	2, 3	240	400-800		
			NNG	2, 3	240	800-1200		
			ND6, NXD6	2, 3	240	600-1200		
			NPG	2, 3	240	1200-1600		
			PD6, PXD6	2, 3	240	1200-1600		

240V Breaker Series Ratings (continued)

Series Rating kAIR	Main Breaker		Branch Breaker			
	Type	Max. Amperes	Type	Number of Poles	Voltage	Amperes
100000 (cont.)	HPD6, HPXD6, SHPD6 SHPD6-B		ED4	1	240	15-100
			ED4, ED6	2,3	240	15-125
			JD6-A, JXD6-A, JXD2-A	2,3	240	200-400
			SJD6-A, SJD6-B	3	240	200-400
			LD6-A	2,3	240	200-600
			LXD6-A	2,3	240	450-600
			SLD6-A, SLD6-B	3	240	300-600
			MD6, MXD6, SMD6, SMD6-B	2,3	240	500-800
			ND6, NXD6, SND6, SND6-B	2,3	240	500-1200
			PD6, PXD6	2,3	240	1200-1600
			SPD6, SPD6-B	3	240	1400-1600
			QR2, QRH2, HQR2	2,3	240	100-250
			NDGA, NDGB	2, 3	240	50-150
			NFGA, NFGB	2, 3	240	70-250
			NJGA, NJJA	2, 3	240	200-400
			NLGA, NLGB	2, 3	240	400-600
			NMG	2, 3	240	600-800
			NNG	2, 3	240	800-1200
			NPG	2, 3	240	1200-1600
			ED4	1	240	15-100
	ED4, ED6	2,3	240	15-125		
	FD6-A, FXD6-A	2,3	240	70-250		
	JD6-A, JXD6-A, JXD2-A	2,3	240	200-400		
	SJD6-A, SJD6-B	3	240	200-400		
	LD6-A	2,3	240	200-600		
	LXD6-A	2,3	240	450-600		
	SLD6-A, SLD6-B	3	240	300-600		
	MD6, MXD6, SMD6, SMD6-B	2,3	240	500-800		
	ND6, NXD6, SND6, SND6-B	2,3	240	500-1200		
	PD6, PXD6	2,3	240	1200-1600		
	SPD6, SPD6-B	3	240	1400-1600		
	QR2, QRH2, HQR2	2,3	240	100-250		
	NDGA, NDGB	2, 3	240	50-150		
	NFGA, NFGB	2, 3	240	70-250		
	NJGA, NJJA	2, 3	240	200-400		
	NLGA	2, 3	240	400-600		
	NMG	2, 3	240	600-800		
	NNG	2, 3	240	800-1200		
	NPG	2, 3	240	1200-1600		
	ED4	1	240	15-100		
	ED4, ED6	2,3	240	15-125		
	JD6-A, JXD6-A, JXD2-A	2,3	240	200-400		
	SJD6-A, SJD6-B	3	240	200-400		
	LD6-A	2,3	240	200-600		
	LXD6-A	2,3	240	450-600		
	SLD6-A, SLD6-B	3	240	300-600		
	MD6, MXD6, SMD6, SMD6-B	2,3	240	500-800		
	ND6, NXD6, SND6, SND6-B	2,3	240	500-1200		
	PD6, PXD6	2,3	240	1200-1600		
	SPD6, SPD6-B	3	240	1200-1600		
	RD6, RXD6	2,3	240	1600-2000		
	QR2, QRH2, HQR2	2,3	240	100-250		
	NDGA, NDGB	2, 3	240	50-150		
	NFGA, NFGB	2, 3	240	70-250		
	NJGA, NJJA	2, 3	240	200-400		
	NLGA, NLGB	2, 3	240	400-600		
	NMG	2, 3	240	600-800		
	NNG	2,3	240	800-1200		
	NPG	2,3	240	1200-1600		
	SHPD6, SHPD6-B		QP, BQ, BL	1	120/240	15-70
			QPH, BQH, BLH, HQP, HBQ, HBL	2	120/240	15-125
			QAF2, BAF2, QAF, BQAF, BAF, QAFH2, BAFH2, HQAF2, HBAF2, QAFH, BQAFH, BAFH, HQFGA2, HBFGA2, QFGA2, QFGAH2, BFGAH2	3	240	15-100
			BAF, QAF, BAFH, QAFH	1	120	15-20
			QPHF, BQHF, BLHF, QPF, BQF, BLF, QEH, QE, BE, BLEH, BLE	2	120/240	15-20
			QEH, BLEH, QAFH, QE, QPHF, BLHF, QPF, BLE, BLF	1	120	15-30
			ED4, HED4	2	120/240	15-60
			ED4, ED6, HED4, HED6	1	120	15-100
			QT	2,3	240	15-125
			NT	1,2	120/240	15-40
			NGB, HGB, LBG	1,2,3	240	15-125

Molded Case Circuit Breakers

Series Connected Short Circuit Ratings

General

240V Breaker Series Ratings (continued)

Series Rating kAIR	Main Breaker		Branch Breaker			
	Type	Max. Amperes	Type	Number of Poles	Voltage	Amperes
200000 (cont.)	LDGA, LDGB	150 (2P, 3P)	NGB,HGB,LBG	1,2,3	240	15-125
			NDGA, NDGB, HDGA, HDGB	2, 3	240	50-150
	CFD6	250 (2P, 3P)	QP, BQ, BL, QPH, BQH, BLH, HQP, HBQ, HBL	1 2 3	120/240 120/240 240	15-70 15-125 15-100
			QAF2, BAF2, QAF, BQAF, BAF, QAFH2, BAFH2, HQAF2, HBAF2, QAFH, BOAFH, BAFH, HQFGA2, HBFGA2, QFGA2, QF-GAH2, BFGAH2	1	120	15-20
			BAF, QAF, BAFH, QAFH	2	120/240	15-20
			QPHF, BQHF, BLHF, QE, BE, BLE, QPF, BQF, BLF, QEH, BLEH, QAF, BAF	1	120	15-30
			QPHF, BLHF, QE, BLE, QPF, BLF, QEH, BLEH, QAF, BAF	2	120/240	15-60
			ED2	1,2,3	120/240	15-100
			HED4, ED4	1	120	15-100
			ED4, ED6, HED4, HED6	2,3	240	15-125
			FD6-A, FXD6-A, HFD6, HFXD6	2,3	240	70-250
			QJ2H, QJH2, QJ2	2,3	240	60-225
			QPPH, QPP	2	120/240	125-225
			QT	1,2	120/240	15-40
			NGB,HGB,LBG	1,2,3	240	15-125
			NDGA, NDGB, HDGA, HDGB	2, 3	240	50-150
			NFGA, NFGB, HFGA, HFGB	2, 3	240	70-250
			NGB,HGB,LBG	1,2,3	240	15-125
			NDGA, NDGB, HDGA, HDGB	2, 3	240	50-150
			NFGA, NFGB, HFGA, HFGB		240	70-250
	HFD6, HFXD6		240	70-250		
	LFGA, LRGB	250 (2P, 3P)	QPH, BQH, BLH, HQP, HBQ, HBL	2 3	120/240 240	100-125 100
			ED4, ED6	2,3	240	15-125
			FD6-A, FXD6-A, HFD6, HFXD6	2,3	240	70-250
			JXD2-A, JD6-A, JXD6-A, HJD6-A, HJXD6-A	2,3	240	200-400
			QT	1,2	120/240	15-30
			NGB,HGB,LBG	1,2,3	240	15-125
			NDGA, NDGB, HDGA, HDGB	2, 3	240	50-150
			NFGA, NFGB, HFGA, HFGB		240	70-250
			NJGA, HJGA, NJJA		240	200-400
			NGB,HGB,LBG	1,2,3	240	15-125
			NDGA, NDGB, HDGA, HDGB	2, 3	240	50-150
			NFGA, NFGB, HFGA, HFGB		240	70-250
			HFD6, HFXD6		240	70-250
			NJGA, HJGA, NJJA		240	200-400
			NLGA, HLGA, NLGB, HLGB		240	400-600
			NMG, HMG		240	600-800
			MD6, MXD6, HMD6, HMXD6		240	500-800
			NDGA, NDGB, HDGA, HDGB		240	50-150
	NFGA, NFGB, HFGA, HFGB		240	70-250		
	NJGA, HJGA, NJJA		240	200-400		
	NLGA, HLGA, NLGB, HLGB		240	400-600		
	NMG, HMG		240	600-800		
	MD6, MXD6, HMD6, HMXD6		240	500-800		
	NDGA, NDGB, HDGA, HDGB		240	50-150		
	NFGA, NFGB, HFGA, HFGB		240	70-250		
	NJGA, HJGA, NJJA		240	200-400		
	NLGA, HLGA, NLGB, HLGB		240	400-600		
	NMG, HMG		240	600-800		
	MD6, MXD6, HMD6, HMXD6		240	500-800		
	NDGA, NDGB, HDGA, HDGB		240	50-150		
	NFGA, NFGB, HFGA, HFGB		240	70-250		
	NJGA, HJGA, NJJA		240	200-400		
	NLGA, HLGA, NLGB, HLGB		240	400-600		
	NMG, HMG		240	600-800		
	ED4, ED6, HED4, HED6		240	15-125		
	FD6-A, FXD6-A, HFD6, HFXD6		240	70-250		
	JXD2-A, JD6-A, JXD6-A, HJD6-A, HJXD6-A		240	200-400		
	LD6-A, HLD6-A, LXD6-A, HLXD6-A		240	200-600 450-600		
	MD6, MXD6, HMD6, HMXD6		240	500-800		
	ND6, NXD6, SHND6, HND6, HNXD6		240	500-1200		
	NDGA, NDGB, HDGA, HDGB		240	50-150		
	NFGA, NFGB, HFGA, HFGB		240	70-250		
	NJGA, HJGA, NJJA		240	200-400		
	NLGA, HLGA, NLGB, HLGB		240	400-600		
	NMG, HMG		240	600-800		
	CJD6-A	400 (2P, 3P)	FD6-A, FXD6-A, HFD6, HFXD6	2 3	240	70-250
			NDGA, NDGB, HDGA, HDGB	2, 3	240	50-150
			NFGA, NFGB, HFGA, HFGB		240	70-250
			NJGA, HJGA, NJJA		240	200-400
			NDGA, NDGB, HDGA, HDGB		240	50-150
			NFGA, NFGB, HFGA, HFGB		240	70-250
			HFD6, HFXD6		240	70-250
			NJGA, HJGA, NJJA		240	200-400
			FD6-A, FXD6-A, HFD6, HFXD6	2 3	240	70-250
			NDGA, NDGB, HDGA, HDGB	2, 3	240	50-150
			NFGA, NFGB, HFGA, HFGB		240	70-250
			NJGA, HJGA, NJJA		240	200-400
			FD6-A, FXD6-A, HFD6, HFXD6	2, 3	240	70-250
			NDGA, NDGB, HDGA, HDGB	2, 3	240	50-150
			NFGA, NFGB, HFGA, HFGB		240	70-250
			NJGA, HJGA, NJJA		240	200-400
			NLGA, HLGA, NLGB, HLGB		240	400-600
			QPH, BQH, BLH, HQP, HBQ, HBL	2 3	120/240 240	100-125 100
	ED4, ED6	2,3	240	15-125		
	FD6-A, FXD6-A, HFD6, HFXD6	2,3	240	70-250		
	JXD2-A, JD6-A, JXD6-A, HJD6-A, HJXD6-A	2,3	240	200-400		
	LD6-A, HLD6-A	2,3	240	200-600		

240V Breaker Series Ratings (continued)

Series Rating kAIR	Main Breaker		Branch Breaker			
	Type	Max. Amperes	Type	Number of Poles	Voltage	Amperes
200000 (cont.)	CLD6-A (cont.)	600 (2P, 3P)	LXD6-A, HJXD6-A	2,3	240	450-600
			QT	1,2	120/240	15-30
			NGB,HGB,LBG	1,2,3	240	15-125
			NDGA, NDGB, HDGA, HDGB	2 - 3	240	50-150
			NFGA, NFGB, HFGA, HFGB		240	70-250
			NJGA, HJGA, NJJA		240	200-400
			NLGA, HLGA, NLGB, HLGB		240	400-600
			NGB,HGB,LBG	1,2,3	240	15-125
			NDGA, NDGB, HDGA, HDGB	2, 3	240	50-150
			NFGA, NFGB, HFGA, HFGB		240	70-250
			HFD6, HFXD6		240	70-250
			NJGA, HJGA, NJJA		240	200-400
			NLGA, HLGA, NLGB, HLGB		240	400-600
			ED4	1	240	15
			ED4, ED6, HED4, HED6	2,3	240	15-125
			FD6-A, FXD6-A, HFD6, HFXD6	2,3	240	70-250
			JXD2-A, JD6-A, JXD6-A, HJD6-A, HJXD6-A	2,3	240	200-400
			LD6-A, HLD6-A, LXD6-A, HLXD6-A	2,3	240	200-600 450-600
	MD6, MXD6, HMD6, HMXD6	2,3	240	500-800		
	NDGA, NDGB, HDGA, HDGB	2,3	240	50-150		
	NFGA, NFGB, HFGA, HFGB	2,3	240	70-250		
	NJGA, HJGA, NJJA	2,3	240	200-400		
	NLGA, HLGA, NLGB, HLGB	2,3	240	400-600		
	NMG, HMG	2,3	240	600-800		
	HFD6, HFXD6	2,3	240	70-250		
	MD6, MXD6	2,3	240	400-800		
	HMD6, HMXD6	2,3	240	400-800		
	NDGA, NDGB, HDGA, HDGB	2,3	240	50-150		
	NFGA, NFGB, HFGA, HFGB	2,3	240	70-250		
	NJGA, HJGA, NJJA	2,3	240	200-400		
	NLGA, HLGA, NLGB, HLGB	2,3	240	400-600		
	NMG, HMG	2,3	240	600-800		
	MD6, MXD6, HMD6, HMXD6	2,3	240	500-800		
	NDGA, NDGB, HDGA, HDGB	2,3	240	50-150		
	NFGA, NFGB, HFGA, HFGB	2,3	240	70-250		
	NJGA, HJGA, NJJA	2,3	240	200-400		
	NLGA, HLGA, NLGB, HLGB	2,3	240	400-600		
	NMG, HMG	2,3	240	600-800		
	ED4, ED6, HED4, HED6		240	15-125		
	FD6-A, FXD6-A, HFD6, HFXD6		240	70-250		
	JXD2-A, JD6-A, JXD6-A, HJD6-A, HJXD6-A		240	200-400		
	LD6-A, HLD6-A, LXD6-A, HLXD6-A		240	200-600 450-600		
	MD6, MXD6, HMD6, HMXD6		240	500-800		
	ND6, NXD6, SHND6, HND6, HNXD6		240	500-1200		
	NDGA, NDGB, HDGA, HDGB		240	50-150		
	NFGA, NFGB, HFGA, HFGB		240	70-250		
	NJGA, HJGA, NJJA		240	200-400		
	NLGA, HLGA, NLGB, HLGB		240	400-600		
	NMG, HMG		240	600-800		

MOLDED CASE CIRCUIT BREAKERS

Molded Case Circuit Breakers

Series Connected Short Circuit Ratings

General

240V Breaker Series Ratings (continued)

Series Rating kAIR	Main Breaker		Branch Breaker				
	Type	Max. Amperes	Type	Number of Poles	Voltage	Amperes	
200000 (cont.)	LNG	1200 (2P, 3P)	HFD6, HFXD6	2,3	240	70-250	
			MD6, MXD6	2,3	240	400-800	
			HMD6, HMXD6	2,3	240	400-800	
			ND6, NXD6, HND6, HNXD6	2,3	240	600-1200	
			NDGA, NDGB, HDGA, HDGB	2,3	240	50-150	
			NFGA, NFGB, HFGA, HFGB	2,3	240	70-250	
			NJGA, HJGA, NJJA	2,3	240	200-400	
			NLGA, HLGA, NLGB, HLGB	2,3	240	400-600	
			NMG, HMG	2,3	240	600-800	
			SCND6-A, SCND6-B	1200 (3P)	MD6, HMD6, HMXD6, MXD6	2,3	240
	SHMD6, SMD6, SHMD6-B, SMD6-B	2,3	240		400-800		
	NMG, HMG	2,3	240		600-800		
	ND6, HND6, NXD6, HNXD6	2,3	240		500-1200		
	SHND6, SND6, SHND6-B, SND6-B	3	240		500-1200		
	SCND6-A, SCND6-B	1200 (2P, 3P)	NDGA, NDGB, HNDGA, NDGB		2,3	240	50-150
	NFGA, NFGB, HFGA, HFGB		2,3		240	70-250	
	NJGA, HJGA, NJJA		2,3		240	200-400	
	NLGA, HLGA, NLGB, HLGB		2,3		240	400-600	
	NMG, HMG		2,3		240	600-800	
	CPD6		1600 (3P)	FD6-A, FXD6-A, HFD6, HFXD6	2,3	240	70-250
	JXD2-A, JD6-A, JXD6-A, HJD6-A, HJXD6-A			2,3	240	200-400	
	LD6-A, HLD6-A			2,3	240	200-600	
	LXD6-A, HLXD6-A			2,3	240	450-600	
	MD6, MXD6, HMD6, HMXD6			2,3	240	500-800	
	ND6, NXD6, HND6, HNXD6, SND6	2,3		240	500-1200		
	NDGA, NDGB, HDGA, HDGB	2,3		240	50-150		
	NFGA, NFGB, HFGA, HFGB	2,3		240	70-250		
	NJGA, HJGA, NJJA	2,3		240	200-400		
	NLGA, HLGA, NLGB, HLGB	2,3		240	400-600		
	NMG, HMG	2,3	240	600-800			
	LPG	1600 (2P, 3P)	MD6, MXD6, HMD6, HMXD6	2,3	240	400-800	
	ND6, NXD6, HND6, HNXD6		2,3	240	600-1200		
	PD6, PXD6, HPD6, HPXD6		2,3	240	1000-1600		
	NDGA, NDGB, HDGA, HDGB		2,3	240	50-150		
	NFGA, NFGB, HFGA, HFGB		2,3	240	70-250		
	HFD6, HFXD6		2,3	240	70-250		
	NJGA, HJGA, NJJA		2,3	240	200-400		
	NLGA, HLGA, NLGB, HLGB		2,3	240	400-600		
	NMG, HMG		2,3	240	600-800		

480V Breaker Series Ratings

Series Rating kAIR	Main Breaker		Branch Breaker						
	Type	Max. Amperes	Type	Number of Poles	Voltage	Amperes			
18,000	ED4	125 (2 & 3P)	BQD, CQD	1,2,3	15-100	277/480			
			BQD, CQD	1,2,3	15-100	277/480			
	25,000	ED6	125 (2P & 3P)	BQD, CQD	1	15-100	277		
				BQD, CQD	2	15-100	277/480		
		HED6	BQD, CQD	1,2,3	15-100	277/480			
			ED4	1	15-100	277			
	35,000	FD6-A, FXD6-A	250 (2P & 3P)	NGB, HGB, LBG	1	15-125	277		
					2	15-125	277/480		
					3	15-125	277/480		
		JD6-A, JXD6-A	400 (2P & 3P)	NGB, HGB, LBG	1	15-125	277		
2					15-125	277/480			
3					15-125	277/480			
42,000		HED4	125 (2P & 3P)	BQD, CQD	1,2,3	15-100	277/480		
				ED4	1	15-100	277		
		HJD6-A, HJXD6-A	400 (2P & 3P)	NGB, HGB, LBG	ED4, ED6	2,3	15-125	480	
					1	15-125	277		
50,000	HFD6, HFXD6	250 (2P & 3P)	NGB, HGB, LBG	2	15-125	277/480			
				3	15-125	277/480			
				HED4	2,3	15-50	480		
	HJD6-A, HJXD6-A, HLD6-A, HLXD6-A	400 (2P & 3P)	600 (2P & 3P)	HED4	2,3	15-50	480		
					FD6-A, FXD6-A	2,3	70-250	480	
					JD6-A, JXD6-A	2,3	200-400	480	
	MD6, MXD6	800 (2P & 3P)	SJD6-A, SJD6-B	LD6-A	LXD6-A	SLD6-A, SLD6-B	3	200-400	480
							3	200-400	480
							2,3	200-600	480
							2,3	450-600	480
3							400-600	480	
2,3							50-150	480	
2,3							70-250	480	
2,3							250-400	480	
2,3							400-600	480	
2,3							600-800	480	
SMD6 SMD6-B	800 (3P)	SJD6-A, SJD6-B	LD6-A	LXD6-A	SLD6-A, SLD6-B	3	200-400	480	
						3	200-600	480	
						2,3	450-600	480	
						3	400-600	480	
						2,3	600-800	480	
						2,3	50-150	480	
						2,3	70-250	480	
						2,3	250-400	480	
						2,3	400-600	480	
						2,3	600-800	480	
ND6, NXD6	1200 (2P & 3P)	SJD6-A, SJD6-B	LD6-A	LXD6-A	SLD6-A, SLD6-B	3	200-400	480	
						3	200-400	480	
						2,3	200-600	480	
						2,3	450-600	480	
						3	400-600	480	
						2,3	50-150	480	
						2,3	70-250	480	
						2,3	250-400	480	
						2,3	400-600	480	
						2,3	600-800	480	
SND6 SND6-B	1200 (3P)	SJD6-A, SJD6-B	LD6-A	LXD6-A	SLD6-A, SLD6-B	3	200-400	480	
						3	200-400	480	
						2,3	200-600	480	
						2,3	450-600	480	
						3	400-600	480	
						2,3	600-800	480	
						2,3	50-150	480	
						2,3	70-250	480	
						2,3	250-400	480	
						2,3	400-600	480	
SPD6, SPD6-B	1600 (3P)	SJD6-A, SJD6-B	LD6-A	LXD6-A	SLD6-A, SLD6-B	3	200-400	480	
						3	200-600	480	
						2,3	450-600	480	
						3	400-600	480	

Molded Case Circuit Breakers

Series Connected Short Circuit Ratings

General

480V Breaker Series Ratings (continued)

Series Rating kAIR	Main Breaker		Branch Breaker					
	Type	Max. Amperes	Type	Number of Poles	Voltage	Amperes		
50,000 (cont.)	PD6, PXD6	1600 (3P)	FD6-A, FXD6-A	2,3	70-250	480		
			JD6-A, JXD6-A	2,3	200-400	480		
			SJD6-A	3	200-400	480		
			LD6-A	2,3	200-600	480		
			LXD6-A	2,3	450-600	480		
			SLD6-A, SLD6-B	3	400-600	480		
			NDGA, NDGB	2,3	50-150	480		
			NFGA, NFGB	2,3	70-250	480		
			NJGA	2,3	250-400	480		
			NLGA, NLGB	2,3	400-600	480		
			NMG	2,3	600-800	480		
			NNG	2,3	800-1200	480		
			NPG	2,3	1200-1600	480		
			RD6, RXD6	18-2000 (3P)	FD6-A, FXD6-A	2,3	70-250	480
			JD6-A, JXD6-A		2,3	200-400	480	
	SJD6-A, SJD6-B	3	200-400		480			
	LD6-A	2,3	200-600		480			
	LXD6-A	2,3	450-600		480			
	SLD6-A, SLD6-B	3	400-600		480			
	NDGA, NDGB	2,3	50-150		480			
	NFGA, NFGB	2,3	70-250		480			
	NJGA	2,3	250-400		480			
	NLGA, NLGB	2,3	400-600		480			
	NMG	2,3	600-800		480			
	NNG	2,3	800-1200		480			
	NPG	2,3	1200-1600		480			
	65,000	HDGA, HDGB	150 (2P & 3P)		NDGA, NDGB	2,3	50-150	480
		HFD6, HFXD6	250 (2P & 3P)		BQD, COD	1,2,3	15-100	277/480
				ED4, HED4	1	15-100	277	
				ED4, ED6, HED4, HED6	2,3	15-125	480	
		HFGA, HFGB	400 (2P & 3P)	NDGA, NDGB	2,3	50-150	480	
				NFGA, NFGB	2,3	70-250	480	
		HJD6-A, HJXD6-A	400 (2P & 3P)	HED4, ED4	1	15-100	277	
FD6-A, FXD6-A				2,3	70-250	480		
JD6-A, JXD6-A				2,3	200-400	480		
NDGA, NDGB				2,3	50-150	480		
NFGA, NFGB				2,3	70-250	480		
HJGA		400 (2P & 3P)	NJGA	2,3	250-400	480		
			NDGA, NDGB	2,3	50-150	480		
			NFGA, NFGB	2,3	70-250	480		
HHJD6, HHJXD6		600 (2P & 3P)	NJGA	2,3	250-400	480		
			NGB,HGB,LBG	1	15-125	277		
			NGB,HGB,LBG	2	15-125	277/480		
HLD6-A, HLXD6-A		600 (2P & 3P)	ED4, HED4	1	15-100	277		
			FD6-A, FXD6-A	2,3	70-250	480		
			JD6-A, JXD6-A	2,3	200-400	480		
			LD6-A	2,3	200-600	480		
			LXD6-A	2,3	450-600	480		
			NDGA, NDGB	2,3	50-150	480		
			NFGA, NFGB	2,3	70-250	480		
			NJGA	2,3	250-400	480		
			NLGA, NLGB	2,3	400-600	480		
			HHLD6, HHLXD6	600 (2P & 3P)	NGB,HGB,LBG	1	15-125	277
	NGB,HGB,LBG				2	15-125	277/480	
	NGB,HGB,LBG				3	15-125	277/480	
	HLGA, HLGB		600 (2P & 3P)	NGB,HGB,LBG	1	15-125*	277	
				NGB,HGB,LBG	2	15-125*	277/480	
				NGB,HGB,LBG	3	15-125*	277/480	
HMD6, HMXD6	800 (2P & 3P)	NDGA, NDGB	2,3	50-150	480			
		NFGA, NFGB	2,3	70-250	480			
		NJGA	2,3	250-400	480			
		NLGA, NLGB	2,3	400-600	480			
		FD6-A, FXD6-A	2,3	70-250	480			
		JD6-A, JXD6-A	2,3	200-400	480			
		LD6-A	2,3	200-600	480			
		LXD6-A	2,3	450-600	480			
		LMD6, LMXD6	2,3	600-800	480			
		MD6, MXD6	2,3	400-800	480			
		NDGA, NDGB, NDGB	2,3	50-150	480			
		NFGA, NFGB	2,3	70-250	480			
NJGA	2,3	250-400	480					
NLGA, NLGB	2,3	400-600	480					
NMG	2,3	600-800	480					

480V Breaker Series Ratings (continued)

Series Rating kAIR	Main Breaker		Branch Breaker					
	Type	Max. Amperes	Type	Number of Poles	Voltage	Amperes		
65,000 (cont.)	HMG	800 (2P & 3P) (cont.)	LMD6, LMXD6	2,3	600-800	480		
			MD6, MXD6	2,3	400-800	480		
			SMD6, SMD6-B	3	500-800	480		
			NDGA, NDGB, NDGB	2,3	50-150	480		
			NFGA, NFGB	2,3	70-250	480		
			NJGA	2,3	250-400	480		
			NLGA, NLGB	2,3	400-600	480		
			NMG	2,3	600-800	480		
			HND6, HNXD6	1200 (2P & 3P)	FD6-A, FXD6-A	2,3	70-250	480
			JD6-A, JXD6-A		2,3	200-400	480	
			LD6-A		2,3	200-600	480	
			LXD6-A		2,3	450-600	480	
			MD6, MXD6		2,3	500-800	480	
			SMD6, SMD6-B		3	500-800	480	
			LMD6, LMXD6		2,3	600-800	480	
	NDGA, NDGB, NDGB	2,3	50-150		480			
	NFGA, NFGB	2,3	70-250		480			
	NJGA	2,3	250-400		480			
	NLGA, NLGB	2,3	400-600		480			
	NMG	2,3	600-800		480			
	NNG	2,3	800-1200		480			
	HNG	1600 (3P)	LMD6, LMXD6		2,3	600-800	480	
	MD6, MXD6		2,3		400-800	480		
	ND6, NXD6		2,3	800-1200	480			
	NDGA, NDGB, NDGB		2,3	50-150	480			
	NFGA, NFGB		2,3	70-250	480			
	NJGA		2,3	250-400	480			
	NLGA, NLGB		2,3	400-600	480			
	NMG		2,3	600-800	480			
	NNG		2,3	800-1200	480			
	HPD6, HPXD6		1600 (2P & 3P)	FD6-A, FXD6-A	2,3	70-250	480	
	NDGA, NDGB, NDGB			2,3	50-150	480		
	NFGA, NFGB			2,3	70-250	480		
NJGA	2,3			250-400	480			
NLGA, NLGB	2,3			400-600	480			
NMG	2,3			600-800	480			
NNG	2,3	800-1200		480				
NPG	2,3	1200-1600		480				
HPG	18-2000 (3P)	LMD6, LMXD6		2,3	600-800	480		
MD6, MXD6		2,3		400-800	480			
ND6, NXD6		2,3		800-1200	480			
NDGA, NDGB		2,3		50-150	480			
NFGA, NFGB		2,3		70-250	480			
NJGA		2,3		250-400	480			
NLGA, NLGB		2,3		400-600	480			
NMG		2,3	600-800	480				
NNG		2,3	800-1200	480				
NPG		2,3	1200-1600	480				
100,000		LDGA, LDGB	150 (2P & 3P)	NGB,HGB,LBG	1	15-125*	277	
		CFD6	250 (2P & 3P)	NGB,HGB,LBG	2	15-125*	277/480	
		LFGA, LFGB		NGB,HGB,LBG	3	15-125*	277/480	
				BQD, CQD	1	15-100	277/480	
				BQD, CQD	2,3	15-30	277/480	
	HHFD6, HHFXD6	NGB,HGB,LBG		1	15-125*	277		
		NGB,HGB,LBG		2	15-125*	277/480		
		NGB,HGB,LBG		3	15-125*	277/480		
	HHFD6, HHFXD6	HHFD6, HHFXD6		NDGA, NDGB, HDGA, HDGB	2,3	50-150	480	
				NFGA, NFGB, HFGA, HFGB	2,3	70-250	480	
				HFD6, HFXD6	2,3	70-250	480	
	HHFD6, HHFXD6	HHFD6, HHFXD6		NGB,HGB,LBG	1	15-125*	277	
NGB,HGB,LBG				2	15-125*	277/480		
NGB,HGB,LBG			3	15-125*	277/480			

MOLDED CASE CIRCUIT BREAKERS

Molded Case Circuit Breakers

Series Connected Short Circuit Ratings

General

480V Breaker Series Ratings (continued)

Series Rating kAIR	Main Breaker		Branch Breaker			
	Type	Max. Amperes	Type	Number of Poles	Voltage	Amperes
100,000 (cont.)	HHJXD6, HHJD6,	400 (2P, 3P)	ED4, ED6, HED4, HED6	1	15-100	277
			HFD6, HFXD6, FXD6-A, FD6-A	2,3	70-250	480
			NDGA, NDGB, HDGA, HDGB	2,3	50-150	480
			NFGA, NFGB, HFGA, HFGB	2,3	70-250	480
			NJGA, HJGA	2,3	200-400	480
				1	15-125*	277
	CJD6-A		1	15-125*	277/480	
			2	15-125*	277/480	
			3	15-125*	277/480	
	LJGA		NDGA, NDGB, HDGA, HDGB	2,3	50-150	480
			NFGA, NFGB, HFGA, HFGB	2,3	70-250	480
			HFD6, HFXD6	2,3	70-250	480
	HHLXD6, HHLXD6	600 (2P, 3P)	ED4, ED6, HED4, HED6	1	15-100	277
			HFD6, HFXD6, FXD6-A, FD6-A	2,3	70-250	480
			NDGA, NDGB, HDGA, HDGB	2,3	50-150	480
			NFGA, NFGB, HFGA, HFGB	2,3	70-250	480
			NJGA, HJGA	2,3	200-400	480
				2,3	50-150	480
	LLGA, LLGB		NDGA, NDGB, HDGA, HDGB	2,3	70-250	480
			HFD6, HFXD6	2,3	70-250	480
			NJGA, HJGA	2,3	200-400	480
	CMD6	800 (3P)	FD6-A, FXD6-A, HFD6-A, HFXD6-A	2,3	70-250	480
			JD6-A, HJD6-A, JXD6-A, HJXD6-A	2,3	200-400	480
			LD6-A, HLD6-A	2,3	200-600	480
			LXD6-A, HLXD6-A	2,3	450-600	480
			MD6, MXD6, HMD6, HMXD6	2,3	500-800	480
			NDGA, NDGB, HDGA, HDGB	2,3	50-150	480
			NFGA, NFGB, HFGA, HFGB	2,3	70-250	480
			NJGA, HJGA	2,3	200-400	480
			NLGA, HLGA, NLGB, HLGB	2,3	400-600	480
			2,3	50-150	480	
			2,3	70-250	480	
			2,3	400-600	480	
LMG	800 (2P, 3P)	NDGA, NDGB, HDGA, HDGB	2,3	50-150	480	
		NFGA, NFGB, HFGA, HFGB	2,3	70-250	480	
		HFD6, HFXD6	2,3	70-250	480	
		NJGA, HJGA	2,3	200-400	480	
		NLGA, NLGB, HLGA, HLGB	2,3	400-600	480	
		MD6, MXD6, HMD6, HMXD6	2,3	500-800	480	
SCMD-A, SCMD6-B	800 (3P)	HFD6, HFXD6	2,3	70-250	480	
SCND6-A, SCND6-B	1200 (3P)	HFD6, HFXD6	2,3	70-250	480	
LNG	1200 (2P, 3P)	NDGA, NDGB, HDGA, HDGB	2,3	50-150	480	
		NFGA, NFGB, HFGA, HFGB	2,3	70-250	480	
		HFD6, HFXD6	2,3	70-250	480	
		NJGA, HJGA	2,3	200-400	480	
		NLGA, HLGA, NLGB, HLGB	2,3	400-600	480	
		MD6, MXD6, HMD6, HMXD6	2,3	400-800	480	
		ND6, NXD6, HND6, HNXD6	2,3	600-1200	480	

480V Breaker Series Ratings (continued)

Series Rating kAIR	Main Breaker		Branch Breaker			
	Type	Max. Amperes	Type	Number of Poles	Voltage	Amperes
100,000 (cont.)	CND6	1200 (3P)	FD6-A, FXD6-A	2,3	70-250	480
			HFD6-A, HFXD6-A	2,3	70-250	480
			JD6-A, HJD6-A, JXD6-A, HJXD6-A	2,3	200-400	480
			LD6-A, HLD6-A	2,3	200-600	480
			LXD6-A, HLXD6-A	2,3	450-600	480
			MD6, MXD6, HMD6, HMXD6	2,3	500-800	480
			ND6, NXD6, HND6, HNXD6	2,3	500-1200	480
			NDGA, NDGB, HDGA, HDGB	2 - 3	50-150	480
			NFGA, NFGB, HFGA, HFGB		70-250	480
			NJGA, HJGA		200-400	480
			NLGA, HLGA, NLGB, HLGB		400-600	480
			CPD6	1600 (3P)	FD6-A, FXD6-A, HFD6-A, HFXD6-A	2,3
	NDGA, NDGB, HDGA, HDGB	2,3			50-150	480
	NFGA, NFGB, HFGA, HFGB	2,3			70-250	480
	NJGA, HJGA	2,3			200-400	480
	NLGA, HLGA, NLGB, HLGB	2,3			400-600	480
		2,3			50-150	480
	LPG (2,3P)	1600 (2P, 3P)	NDGA, NDGB, HDGA, HDGB	2,3	50-150	480
			NFGA, NFGB, HFGA, HFGB	2,3	70-250	480
			HFD6, HFXD6	2,3	70-250	480
			NJGA, HJGA	2,3	200-400	480
			NLGA, NLGB, HLGA, HLGB	2,3	400-600	480
			MD6, MXD6, HMD6, HMXD6	2,3	500-800	480
	ND6, NXD6, HND6, HNXD6	2,3	500-1200	480		
	PD6, PXD6, HPD6, HPXD6	2,3	1200-1600	480		
	CJD6-A	400 (2P, 3P)	ED4	1	15-100	277
			HFD6, HFXD6	2,3	70-250	480
			JD6-A, HJD6-A, JXD6-A, HJXD6-A	2,3	200-400	480
				1	15-100	277
			HFD6, HFXD6	2,3	70-250	480
JD6-A, HJD6-A, JXD6-A, HJXD6-A			2,3	200-400	480	
CLD6-A	600 (2P, 3P)	LD6-A, HLD6-A	2,3	200-600	480	
		LXD6-A, HLXD6-A	2,3	450-600	480	
			1	15-100	277	
		ED4, HED4	1	15-100	277	
		ED4, ED6, HED4, HED6	2,3	15-125	480	
		NGB,HGB, LBG	1	15-125	277	
2	15-125	277/480				
3	15-125	277/480				
CED6	125 (2P, 3P)	BQD, CQD	1	15-100	277	
			2,3	20-30	277/480	
		ED4, HED4	1	15-100	277	
		ED4, ED6, HED4, HED6	2,3	15-125	480	
			1	15-100	277	
			2,3	20-30	277/480	
CFD6	250 (2P, 3P)	BQD, CQD	1	15-100	277	
			2,3	20-30	277/480	
		ED4, ED6	2,3	15-50	277	
		ED4, HED4	1	15-100	480	
		HED4, HED6	2,3	15-125	480	
		FD6-A, FXD6-A, HFD6, HFXD6	2,3	70-250	480	
			1	15-125	277	
			2	15-125	277/480	
			3	15-125	277/480	

Molded Case Circuit Breakers

Series Connected Short Circuit Ratings

General

240V Fuse Series Ratings

Series Rating kAIR	Main Fuse		Branch Breaker			
	Type	Max. Amperes	Type	Number of Poles	Max. Amperes	
65,000	J, R	15-600 (1,2,3P)	OPH, BOH, BLH	1,2,3	15-125	
	T	15-1200 (1,2,3P)	OPH, BOH, BLH	1,2,3	15-125	
	L	601-6000 (1,2,3P)	OPH, BOH, BLH	1,2,3	15-125	
100,000	T (300V)	15-200 (1,2,3P)	QP, BO, BL	1,2,3	15-125	
			HQP, HBQ, HBL, OPH, BOH, BLH	3	15-100	
			OPF, BOF, BLF, QHPF, QE, BE, BLE, QEH, BLEH, BLHF, BOHF, QAF, BAF, QAFH, BAFH	1	15-30	
			QEH, BLEH, QE, QPF, QPHF, BLHF, BLE, BLF, QAF, BAF, QAFH, BAFH	2	15-60	
			QT	1,2	15-50	
		15-600 (1,2,3P)	OPH, BOH, BLH, HQP, HBQ, HBL	1,2	15-125	
	J, R	15-600 (2,3P)	ED4, HED4	1	15-100	
			ED4, ED6, HED4, HED6	2,3	15-125	
			QAF2, BAF2, QAFH2, BAFH2, QFGA2, BFGA2, QFGAH2, BFGAH2	1	15-20	
			QPF2, BLF2, HQPF2, HBLF2, QPHF2, BLHF2	1	15-30	
			FD6-A, FXD6-A	2,3	70-250	
			70-600 (2,3P)	QR2, QRH2, HQR2	2,3	100-250
			200-600 (2,3P)	JD6-A, JXD6-A, JXD2-A, SJD6-A, SJD6-B	2,3	200-400
			300-600 (3P)	LD6-A	2,3	200-600
			450-600 (2,3P)	SLD6-A, SLD6-B	3	300-600
			LXD6-A	2,3	450-600	
T	15-1200 (2,3P)	ED4, HED4	1	15-100		
		ED4, ED6, HED4, HED6	2,3	15-125		
		QAF2, BAF2, QAFH2, BAFH2, HQAF2, HBAF2, QFGA2, BFGA2, QFGAH2, BFGAH2	1	15-20		
		QPF2, BLF2, HQPF2, HBLF2, QPHF2, BLHF2	1	15-30		
		FXD6-A, FD6-A	2,3	70-250		
		70-1200 (2,3P)	QR2, QRH2, HQR2	2,3	100-250	
		100-600 (2,3P)	LXD6-A	2,3	450-600	
		450-1200 (2,3P)	JD6-A, JXD6-A, JXD2-A	2,3	200-400	
		200-1200 (2,3P)	SJD6-A, SJD6-B	3	200-400	
		300-1200 (3P)	LD6-A	2,3	200-600	
100,000	L	601-6000 (2,3P)	SLD6-A, SLD6-B	3	300-600	
			SMD6, SMD6-B	3	500-800	
			SND6, SND6-B	3	500-1200	
			PD6, PXD6, SPD6	3	1200-1600	
			RD6, RXD6	3	1600-2000	

240V Fuse Series Ratings (continued)

Series Rating kAIR	Main Fuse		Branch Breaker			
	Type	Max. Amperes	Type	Number of Poles	Max. Amperes	
200,000	R	125-200 (2,3P)	QJH2, QJ2H, QJ2	2,3	125-200	
			125-600 (2,3P)	QJH2, QJ2H	2,3	125-225
			125-400 (2,3P)	QJ2	2,3	125-225
	J, R	70-600 (2,3P)	HFD6, HFXD6	2,3	70-250	
			70-1200	HFD6, HFXD6	2,3	70-250
	T	600-1200 (2,3P)	NMG, HMG	2,3	600-800	
			HFD6, HFXD6	2,3	70-250	
	L	601-6000 (2,3P)	MD6, MXD6, HMD6, HMXD6	2,3	500-800	
			NMG, HMG	2,3	600-800	
			ND6, NXD6, HND6, HNXD6	2,3	500-1200	
	J,R	15-600 (1,2,3P)	NGB,HGB, LBG	1,2,3	15-125	
			NDGA, HDGA	2,3	50-150	
	J,R	70-600 (2,3P)	NFGA, HFGA	2,3	70-250	
			NJGA, HJGA	2,3	200-400	
	J,R	400,600 (1,2,3P)	NLGA, HLGA	2,3	400-600	
15-1200 (1,2,3P)			NGB,HGB, LBG	1,2,3	15-125	
T	50-1200 (2,3P)	NDGA, HDGA	2,3	50-150		
		70-1200 (2,3P)	NFGA, HFGA	2,3	70-250	
T	200-1200 (2,3P)	NJGA, HJGA	2,3	200-400		
		400-1200 (2,3P)	NLGA, HLGA	2,3	400-600	
L	601-6000 (2,3P)	NDGA, HDGA	2,3	50-150		
		NFGA, HFGA	2,3	70-250		
		NJGA, HJGA	2,3	200-400		

Molded Case Circuit Breakers

Series Connected Short Circuit Ratings

General

480V Fuse Series Ratings

Series Rating kAIR	Main Fuse		Branch Breaker				
	Type	Max. Amperes	Type	Number of Poles	Max. Amperes		
50,000	J	60-400 (1,2,3P)	ED4	1	60-100		
	J	15-400 (2,3P)	ED4	2,3	15-100		
	J	15-400 (1,2,3P)	ED4	1	15-50		
100,000	T, J	70-600 (2,3P)	FD6-A, FXD6-A	2,3	70-250		
	J, R	70-600 (2,3P)	HFD6, HFXD6	2,3	70-250		
	T, J, R	200-600 (2,3P)	JD6-A, JXD6-A	2,3	200-400		
			HJD6-A, HJX	2,3	200-600		
			LD6-A, HLD6	2,3	200-600		
	T	450-600 (2,3P)	LXD6-A, HLD6	2,3	450-600		
			70-1200 (2,3P)	HFD6, HFXD6	2,3	70-250	
				JD6-A, JXD6-A	2,3	200-400	
	T, L	601-1200 (2,3P)	HJD6-A, HJX	2,3	200-600		
			LD6-A, HLD6	2,3	200-600		
			LXD6-A, HLD6	2,3	450-600		
			HFD6, HFXD6	2,3	70-250		
	L	601-6000 (2,3P)	MD6, MXD6	2,3	500-800		
			HMD6, HMXD6	2,3	500-800		
			ND6, NXD6	2,3	500-1200		
			HND6, HNXD6	2,3	500-1200		
			NDGA, HDGA	2,3	50-150		
			NFGA, HFGA	2,3	70-250		
			NJGA, HJGA	2,3	200-400		
			NLGA, HLGA	2,3	400-600		
			J,R	50-600 (2,3P)	NDGA, HDGA	2,3	50-150
			J,R	70-600 (2,3P)	NFGA, HFGA	2,3	70-250
	J,R	200-600 (2,3P)	NJGA, HJGA	2,3	200-400		
	J,R	400-600 (2,3P)	NLGA, HLGA	2,3	400-600		
T	601-1200 (2,3P)	NDGA, HDGA	2,3	50-150			
T	601-1200 (2,3P)	NFGA, HFGA	2,3	70-250			
T	601-1200 (2,3P)	NJGA, HJGA	2,3	200-400			
T	601-1200 (2,3P)	NLGA, HLGA	2,3	400-600			
L	601-6000 (2,3P)	NDGA, HDGA	2,3	50-150			
		NFGA, HFGA	2,3	70-250			
		NJGA, HJGA	2,3	200-400			
		NLGA, HLGA	2,3	200-400			
		200,000	R	15-100 (1,2,3P)	BQD, CQD	1	15-100
					BQD, CQD	2,3	20-30
				15-200 (1,2,3P)	BQD, CQD	1	15-100
					BQD, CQD	2,3	20-30

Molded Case Circuit Breakers

IEC 947-2® AC Interrupting Ratings, 50/60 HZ KA

Reference

Ampere Rating	Breaker Frame	Breaker Type	220/240 Volts		380/415 Volts		500 Volts	
			Icu	Ics	Icu	Ics	Icu	Ics
15-125	ED	ED6	65	17	35	9	—	—
70-250	FD	FXD6	65	33	35	18	—	—
		HFXD6	100	50	65	33	—	—
		HHFXD6	200	100	100	50	—	—
250-400	JD	JXD6(A)	65	33	40	20	—	—
		HJXD6(A)	100	50	65	33	—	—
400-600	LD	LXD6(A)	65	33	40	20	—	—
		HLXD6(A)	100	50	65	33	—	—
600-800	MD	MXD6	65	33	40	20	—	—
		HMXD6	100	50	65	33	—	—
800-1200	ND	NXD6	65	33	40	20	—	—
		HNXD6	100	50	65	33	—	—

Molded Case Circuit Breakers

Typical Specifications

Reference

General Specifications

Molded case circuit breakers shall provide circuit overcurrent protection with inverse time and instantaneous tripping characteristics and shall be Siemens Sentron, Sensitrip or approved equal.

All circuit breakers shall be listed by Underwriters' Laboratories, Inc., conform to applicable requirements of NEMA Standard Publication No. AB1 and meet appropriate classifications of Federal Specifications W C 375B/Gen.

All circuit breakers shall have a quick-make, quick-break over center toggle type mechanism and the handle mechanism shall be trip free to prevent holding contacts closed against a short circuit or sustained overload. All circuit breaker handles shall assume a position between "ON" and "OFF" when tripped automatically. Multi-pole circuit breakers shall be common-trip such that an overload or short circuit on any one pole will result in all poles opening simultaneously. Arc extinction is to be accomplished by magnetic arc chutes. All ratings are to be clearly visible. When reverse feed is indicated on the drawings, in accordance with UL, circuit breakers with sealed trip units shall be supplied.

Thermal Magnetic Specifications

Unless otherwise noted on the drawings, all Circuit breakers 2000 Ampere and below shall have thermal-magnetic trip units, with inverse time-current characteristics. Automatic operation of these circuit breakers shall be obtained by means of thermal-magnetic tripping devices located in each pole providing inverse time delay and instantaneous circuit protection. Circuit breakers shall be ambient compensating in that, as the ambient temperature increases over 40°C, the circuit breaker automatically derates itself so as to better protect its associated conductor. Thermal magnetic breakers from 250 to 2000A frames shall have thermal interchangeable trip units, with instantaneous magnetic trip settings that are adjustable and accessible from the front of all circuit breakers on frame sizes 250 Amperes and above. Where indicated, provide circuit breakers UL listed for application at 100% of their continuous ampere rating in their intended enclosure.

Motor Circuit Protectors

Where indicated on the drawings and in the combination motor starter/motor control center schedule, furnish instantaneous magnetic trip only circuit breakers for motor short circuit protection. The magnetic trips shall be adjustable and accessible from the front of all circuit breaker frames. The continuous current rating shall be between 1 and 800 Amperes as indicated on the drawing.

The interrupting rating of the circuit breakers shall be as indicated in the specifications, and shown on the drawing or single line diagram. The interrupting rating of the circuit breakers shall be at least equal to the available short circuit current at the line terminals of the circuit breaker and correspond to the UL listed integrated short circuit current rating specified.

Internal Accessories

Provide shunt trips, bell alarms, and auxiliary switches as shown on the contract drawings. Gold plated auxiliary switches shall be supplied for PLC connection. Internal accessories for all breakers shall be UL listed for field installation and modification.

Connection Accessories

Unless otherwise noted, Mechanical lugs shall be provided with all Molded Case Breakers. Where indicated on the drawings, compression lugs shall be provided on 1200 Ampere frame and below circuit breakers. All compression lugs shall be supplied by the Circuit Breaker Manufacturer. Where indicated on the drawings, UL listed plug-in or rear connectors shall be supplied.

Solid State Sensing Specifications

As indicated on the drawings, circuit breaker frames 400 Ampere through 3200-Ampere shall have microprocessor-based RMS sensing trip units, with the capability to measure through to the 21st harmonic. Automatic operation of all circuit breaker frames 400A and larger shall be obtained by means of solid state tripping elements providing inverse time delay and (instantaneous) and/or (short-time delay) circuit protection. Continuous current ratings shall be adjustable from 20% to 100% of the trip unit rating, without the need for a rating plug. Long-time delay and instantaneous trip shall be adjustable. The optional short-time trip function shall have adjustable pick-up settings, three fixed times, and I²t ramp. Circuit breaker frames 400A and larger, and where indicated on the drawings, shall be 100% equipment rated.

Integral Ground Fault Option

Main and feeder circuit breakers, as indicated on the drawings, shall be provided with integral ground fault protection. Ground fault pick-up shall be adjustable from 20% to 70% of the circuit breakers maximum continuous current rating. Ground fault time delay shall be adjustable with three I²t ramps.

Metering Option

When indicated on the drawings, solid state trip breakers shall be furnished with a plug-in or panel mounted metering device. This device shall simultaneously display all three phase currents, as well as average current, ground current, and phase unbalance. In addition it shall display breaker status, a max log, and a trip log. The trip log will retain and display date, time and type of trip (overload, short circuit or ground fault) for the most recent 5 trip events.

Current Limiting Specifications

Where indicated on the drawings, Siemens current limiting circuit breakers are to be furnished. Current limiting circuit breakers shall limit the let-through I²t to a value less than the I²t of one-half cycle wave of the symmetrical prospective current without any fusible elements when operating within its current range.

Series Connected Combination Specifications

Where protective devices are applied in series combination, such that the prospective available fault current exceeds the interrupting rating (AIR) of the downstream protective devices, such combinations shall be UL recognized combinations. All electrical equipment using these UL recognized circuit breaker combinations shall be clearly marked in accordance with NEC Section 240-83(c).

Molded Case Circuit Breakers

Superseded Breakers

General

Sentron Series	Note	Superseded	Note	Superseded
CED62B015-CED62B125 CED62S100A CED63A001-CED63A125 CED63B015-CED63B125 CED63S100A HHED63B015-HHED63B125	① ① ① ① ① ①	CLE62B015-CLE62B100 CLE62S100 CLE63A001-CLE63A125 CLE63B015-CLE63B100 CLE63S100 HED63B015-HED63B125	③ ③ ③ ③	CE2B015-CE2B100 CE2S100 CE3B015-CEB100 CE3S100
CFD62A150, CFD62L150, CFD62A250 CFD62B070-CFD62B250 CFD62S250A CFD63A150, CFD63L150, CFD63A250 CFD63B070-CFD63B250 CFD63S250A	① ① ① ① ① ①	CLF62A150, CLF62A250 CLF62B070-CLF62B240 CLF62S250 CLF63A150, CLF63A250 CLF63B070-CLF63B250 CLF63S250	③ ③	CJ2B125-CJ2B250 CJ3B125-CJ3B250
CJD62B200-CJD62B400 CJD62H400, CJD62L400 CJD62S400A CJD63B200-CJD63B400 CJD63H400, CJD63L400 CJD63S400A	① ① ① ① ① ①	CLJ62B100-CLJ62B400 CLJ62L400, CLJ62H400 CLJ62S400 CLJ63B200-CLJ63B400 CLJ63L400, CLJ63H400 CLJ63S400	④ ④ ④ ④	CJ2B300-CJ2B400 CJ2S400 CJ3B300-CJ3B400 CJ3S400
CPD63B120-CPD63B160	⑤	CP3B120-CP3B160		
ED21B015-ED21B100 ED22B015-ED22B100 ED22S100A ED23B015-ED23B100 ED23S100A	① ① ① ① ①	E21B015-E21B100 E22B015-E22B100 E22S100A E23B015-E23B100 E23S100A	② ② ② ② ②	EE1B015-EE1B100 EE2B015-EE2B100 EE2S100 EE3B015-EE3B100 EE3S100
ED41B015-ED41B100 ED42B015-ED42B125 ED42S100A ED43B015-ED43B125 ED43S100A	① ① ① ① ①	E41B015-E41B100 E42B015-E42B100 E42S100 E43B015-E43B100 E43S100	② ② ② ② ②	EH1B015-EH1B100 EH2B015-ED2B125 EH2S100 EH3B015-EH3B100 EH3S100
ED61B015-ED61B100 ED62B015-ED62B125 ED62S100A ED63A001-ED63A125 ED63B015-ED63B125 ED63S100A HHED63B015-HHED63B125	① ① ① ① ① ① ①	E61B015-E61B100 E62B015-E62B100 E62S100A E63A001-E63A125 E63B015-E63B100 E63S100A HED63B015-HED63B125	② ② ② ② ② ② ②	EF1B015-EF1B020 EF2B015-EF2B100 EF2S100 EF3A003, EF3J050, EF3L050-EF3A100, EF3H1 EF3B015-EF3B100 EF3S100
FD62B070-FD62B250 ^⑥ FD63B070-FD63B250 ^⑥	① ①	F62B070, F62B250 F63B070-F63B250		
FXD62A150, FXD62L150, FXD62A250 FXD62B070-FXD62B250 ^⑥ FXD62S250A FXD63A150, FXD63L150, FXD63A250 FXD63B070-FXD63B250 ^⑥ FXD63S250A	① ① ① ① ① ①	FJ62A150, FJ62L150-FJ62A250 FJ62B070-FJ62B250 FJ62S250 FJ63A150, FJ63L150-FJ63A250 FJ63B070-FJ63B250 FJ63S250	② ② ② ② ② ②	FJ2B070-FJ2B225 FJ2S225 FJ3A225 FJ3B070-FJ3B225 FJ3S225
HED41B015-HED41B100 HED42B015-HED42B125 HED43B015-HED43B125	① ① ①	HE41B015-HE41B100 HE42B015-HE42B100 HE43B015-HE43B100		
HED61B015-HED61B100 HED63B015-HED63B125	① ①	HE61B015-HE61B100 HE63B015-HE63B100	② ②	HE2B015-HE2B100 HE3B015-HE3B100
HFD62B070-HFD62B250 HFD63B070-HFD63B250	① ①	HF62B070-HF62B250 HF63B070-HF63B250		
HHED63B015-HHED63B125	①	HED63B015-HED63B125		
HJD63B200-HJD63B400	①	HJ63B200-HJ63B400	②	HJ3B125-HJ3B400
HLD63B250-HLD63B600	①	HL63B450-HL63B600	②	HL3B450-HL3B600
HMD63B500-HMD63B800	②	HN3B500-HN3B800		
HND63B100-HND63B120	②	HK3B100-HK3B120		
HPD63B120-HPD63B160	②	HP3B120-HP3B160		
HRD63B160-HRD63B200	②	HR3B160-HR3B200		

① Mechanically and electrically interchangeable.

② Electrically interchangeable only, refer to sales office for further details.

③ Electrically interchangeable only if the system interrupting capacity is less than or equal to:
200 kA at 240V AC
200 kA at 480V AC
100 kA at 600V AC

④ Electrically interchangeable only if the system interrupting capacity is less than or equal to:

200 kA at 240V AC
150 kA at 480V AC
100 kA at 600V AC

⑤ Refer to local sales office for replacement information.

⑥ Effective 1994 — The FD6 and FXD6 types have been replaced by FD6-A and FXD6-A type thermal / magnetic circuit breakers — mechanically and electrically interchangeable with the exception that FXD6-A and FD6-A have 22kA at 600V AC ratings versus 18kA at 600V AC for types FXD6 and FD6.

Molded Case Circuit Breakers

Superseded Breakers

General

Sentron Series	Note	Superseded	Note	Superseded
JD62B200-JD62B400	①	JLB200-JL62B400	②	JL2B070-JL2B400
JD63B200-JD63B400	①	JL63B200-JL63B400	②	JL3B0L0-JL3B400
JXD22B200-JXD22B400	①	JD22B200-JD22B400	②	JD2B250-JD2B400
JXD22S400A	①	JD22S400	②	JD2S400
JXD23B200-JXD23B400	①	JD23B200-JD23B400	②	JD3B250-JD3B400
JXD23S400A	①	JD23S400	②	JD3S400
JXD62B200-JXD62B400	①	JJ62B200-JJ62B400	②	JJ2B250-JJ2B400
JXD62H400, JXD62L400	①	JL62L400, JL62H400	②	JL2L400-JL2H400
JXD62S400A	①	JJ62S400A		
JXD63B200-JXD63B400	①	JJ63B200-JJ63B400	②	JJ3B200-JJ3B400
JXD63H400, JXD63L400	①	JL63A400, JL63H400, JL63L400	②	JL3H400, JL3L400, JL3A225
JXD63S400A	①	JJ63S400A		
LD62B250-LD62B500	①	LL63B250-LL62B600	②	LL2B450-LL2B600
LD62B250-LD63B600	①	LL63B250-LL63B600	②	LL3B450-LL3B600
LXD62B450-LXD62B600	①	LJ62B450-LJ62B600		
LXD62J600, LXD62L600	②	LL2H600, LL2U600, LL2X600		
LXD62S600A	①	LJ62S600		
LXD63B450-LXD63B600	①	LJ63B450-LJ63B600		
LXD64H600, LXD63L600	①	LL63H600, LL63L600	②	LL3A450, LL3H600
LXD63S600A	①	LJ63S600A	②	LL3S600
MD62B500-MD62B800	②	KM2B500-KM2B800		
MD63B500-MD63B800	②	KM3B500-KM3B800		
MXD62A800, MXD62H800, MXD62L800	②	KM2A800, KM2H800, KM2L800		
MXD62S800A	②	KM2S800		
MXD63A800, MXD63H800, MXD63L800	②	KM3A600, KM3H800, KM3L800		
MXD63S800A	②	KM3S800		
ND63B100-ND63B900	②	KP3B100-KP3B900		
NXD63S120A	②	KP3S120		
PD63B120-PD63B160	②	HP3B120-HP3B160		
PXD63S160A	②	HP3S160		
RD63B160-RD63B200	②	HR3B160-HR3B200		
QR22B100 – QR22B225		QJ22B060-QJ22B225		
QR22B100H – QR22B225H		QJ22B060H-QJ22B225H		
HQR23S250HA		QJ22S225		
QJ23B100 – QR23B225		QJ23B060-QJ23B225		
QR23B100H – QR23B225H		QJ23B060H-QJ23B225H		
QRH22B100 – QRH22B225		QJH22B060-QJH22B225		
QRH23B100 – QRH23B225		QJH23B060-QJH23B225		
HQR23S250HA		QJH23S225	①	
QJH22B060-QJH22B225	①	QJ2H125-QJ2B225		
QJH23B060-QJH23B225	①	QJ3H125-QJ3H225		
QJH23S225	①	QJ3S225		
RD63B160-RD63B200	②	HR3B160-HR3B200		
RXD63S200A	②	HR3S200		
SCJD6B200LI-SCJD6B400LI	①	SCJD69200-SCJD69400		
SCJD6B200LIG-SCJD6B400LIG	①	SCJD69200G-SCJD69400G		
SCJD6B200LSIG-SCJD6B400LSIG	①	SCJD69200NGT-SCJD69400NGT		
SCJD6B200LSI-SCJD6B400LSI	①	SCJD69200NT-SCJD69400NT		
SCLD6B300LI-SCLD6B600LI	①	SCLD69300-SCLD69600		
SCLD6B300LIG-SCLD6B600LIG	①	SCLD69300G-SCLD69600G		
SCLD6B300LSIG-SCLD6B600LSIG	①	SCLD69300NGT-SCLD69600NGT		
SCLD6B300LSI-SCLD6B600LSI	①	SCLD69300NT-SCLD69600NT		
SCMD6B600LI-SCMD6B800LI	①	SCMD69600A-SCMD69800A		
SCMD6B600LIG-SCMD6B800LIG	①	SCMD69600AG-SCMD69800AG		
SCMD6B600LSIG-SCMD6B800LSIG	①	SCMD69600ANGT-SCMD69800ANGT		
SCMD6B600LSI-SCMD6B800LSI	①	SCMD69600ANT-SCMD69800ANT		

①Mechanically and electrically interchangeable.

②Electrically interchangeable only, refer to sales office for further details.

③Electrically interchangeable only if the system interrupting capacity is less than or equal to:
200 kA at 240V AC
200 kA at 480V AC
100 kA at 600V AC④Electrically interchangeable only if the system interrupting capacity is less than or equal to:
200 kA at 240V AC
150 kA at 480V AC
100 kA at 600V AC

⑤Refer to local sales office for replacement information.

Molded Case Circuit Breakers

Superseded Breakers

General

Sentron Series	Note	Superseded	Note	Superseded
SCND6B800LI-SCND6B120LI	①	SCND69800A-SCND69120A		
SCND6B800LIG-SCND6B120LIG	①	SCND69800AG-SCND69120AG		
SCND6B800LSIG-SCND6B120LSIG	①	SCND69800ANGT-SCND69120ANGT		
SCND6B800LSI-SCND6B120LSI	①	SCND69800ANT-SCND69120ANT		
SHJD6B200LI-SHJD6B400LI	①	SHJD69200-SHJD69400	①	SHJ63B200-SHJ63B400G
SHJD6B200LIG-SHJD6B400LIG	①	SHJD69200G-SHJD69400G	①	SHJ63B200G-SHJ63B400G
SHJD6B200LSIG-SHJD6B400LSIG	①	SHJD69200NGT-SHJD69400NGT	①	SHJ63N200G-SHJ63N400G
SHJD6B200LSI-SHJD6B400LSI	①	SHJD69200NT-SHJD69400NT	①	SHJ63N200-SHJ63N400
SHLD6B300LI-SHLD6B600LI	①	SHLD69300-SHLD69600	①	SHL63B300-SHL63B600
SHLD6B300LIG-SHLD6B600LIG	①	SHLD69300G-SHLD69600G	①	SHL63B300G-SHL63B600G
SHLD6B300LSIG-SHLD6B600LSIG	①	SHLD69300NGT-SHLD69600NG	①	SHL63N300G-SHL63N600G
SHLD6B300LSI-SHLD6B600LSI	①	SHLD69300NT-SHLD69600NT	①	SHL63N300-SHL63N600
SHND6B100LI-SHND6B120LI	①	SHND69100A-SHND69120A	①	SHND69100-SHND69800
SHND6B100LIG-SHND6B120LIG	①	SHND69100AG-SHND69120AG	①	SHND69100G-SHND69800G
SHPD6B140LI-SHPD6B160LI	①	SHPD69140-SHPD69160	②	SHPF3B120-SHPF3B160
SHPD6B140LIG-SHPD6B160LIG	①	SHPD69140G-SHPD69160G	②	SHPF3B120G-SHPF3B160G
SHND6B100LSIG-SHND6B120LSIG	①	SHND69100NGT-SHND69800NGT	①	SHKF3N100G-SHKF3N800G
SHND6B100LSI-SHND6B120LSI	①	SHND69100NT-SHND69800NT	②	SHKF3N100-SHKF3N800
SJD6B200LI-SJD6B400LI	①	SJD69200-SJ369400	①	SJL63B200-SJL63B400
SJD6B200LIG-SJD6B400LIG	①	SJD69200G-SJD69400G	①	SJL63B200G-SJL63B400G
SJD6B200LSIG-SJD6B400LSIG	①	SJD69200NGT-SJD69400NGT	①	SJL63N200G-SJL63N400G
SJD6B200LSI-SJD6B400LSI	①	SJD69200NT-SJD69400NT	①	SJL63N200-SJL63N400
SLD6B300LI-SLD6B600LI	①	SLD69300-SLD69600	①	SLL63B300-SLL63B600
SLD6B300LIG-SLD6B600LIG	①	SLD69300G-SLD69600G	①	SLL63B300G-SLL63B600G
SLD6B300LSIG-SLD6B600LSIG	①	SLD69300NGT-SLD69600NGT	①	SLL63N300G-SLL63N600G
SLD6B300LSI-SLD6B600LSI	①	SLD69300NT-SLD69600NT	①	SLL63N300-SLL63N600
SMD6B600LI-SMD6B800LI	①	SMD69600A-SMD69800A	①	SMD69600-SMD69800
SMD6B600LIG-SMD6B800LIG	①	SMD69600AG-SMD69800AG	①	SMD69600G-SMD69800G
SMD6B600LSIG-SMD6B800LSIG	①	SMD69600ANGT-SMD69800ANGT	①	SMD69600NGT-SMD69800NGT
SMD6B600LSI-SMD6B800LSI	①	SMD69600ANT-SMD69800ANT	①	SMD69600NT-SMD69800NT
SND6B800LI-SND6B120LI	①	SND69800A-SND69120A	①	SND69100-SND69800
SND6B800LIG-SND6B120LIG	①	SND69800AG-SND69120AG	①	SND69100G-SND69800G
SND6B800LSIG-SND6B120LSIG	①	SND69800ANGT-SND69120ANGT	①	SND69100NGT-SND69800NGT
SND6B800LSI-SND6B120LSI	①	SND69800ANT-SND69120ANT	①	SND69100NT-SND69800NT
SHPD6B140LI-SHPD6B160LI	①	SPD69140-SPD69160	②	SHPF3B120-SHPF3B160
SHPD6B140LIG-SHPD6B160LIG	①	SPD69140G-SPD69160G	②	SHPF3B120G-SHPF3B160G
SHPD6B140LSIG-SHPD6B160LSIG	①	SPD69140NGT-SPD69160NGT	②	SHPF3N120-SHPF3N160G
SHPD6B140LSI-SHPD6B160LSI	①	SPD69140NT-SPD69160NT	②	SHPF3N120G-SHPF3N160G
—	④	BQCC1B015-BQC1B030		
—	④	CC1B015-CC1B030		
—	④	CC2B015-CC2B030		
—	④	CC3B015-CC3B030		
—	④	EF2A003, EF2H050, EF2L050, EF2A100		
—	④	EF2H150, EF2L150		
—	④	EH1B015-EH1B100		
—	④	EH2B015-EH2B100		
—	④	EH3B015-EH3B100		
—	③	HE2A003, HE2H050, HE2L050-HE2A100		
—	③	HE3A003, HE3H050, HE3L050-HE3A100		
—	③	HE3B015-HE3B100		

7
MOLDED CASE
CIRCUIT BREAKERS

①Mechanically and electrically interchangeable.
 ②Electrically interchangeable only, refer to sales office for further details.
 ③These units are for replacement purposes only. Consult sales office for availability.

④These units are no longer manufactured, and no replacement is available.

Molded Case Circuit Breakers

Notes

7

MOLDED CASE
CIRCUIT BREAKERS