

PRODUCT CODE:
ER210SWH-UD1
ER210DWH-UD2

LED SINGLE REMOTE HEAD EMERGENCY LIGHT 5V - 12VDC
LED DOUBLE REMOTE HEAD EMERGENCY LIGHT 5V - 12VDC



PRODUCT CODE:
ER250SWH-UD5 / ER270SWH-UD7
ER250DWH-UD10 / ER270DWH-UD14

LED SINGLE REMOTE HEAD EMERGENCY LIGHT 6V - 12VDC
LED DOUBLE REMOTE HEAD EMERGENCY LIGHT 6V - 12VDC



HOUSING/MOUNTING

The new ER200-UD series of Etlin-Daniels LED Remote Emergency Head units offers a wide choice of single and dual head options in 1W heads in 5V-12VDC, 5W heads and 7W heads in 6V-12VDC. The compact, impact resistant injection-molded thermoplastic housings allow for both wall and ceiling surface mounting, and the clear PC lens and internal aluminum reflector provide for bright illumination. Each head has an adjustable swivel lock to provide for easy positioning, and the standard canopy is designed to mount directly to typical electrical junction boxes.

FEATURES

- Compact Single & Dual Remote Head Emergency Light Source.
- Injection-molded thermoplastic housing
- Wall & ceiling surface mountable
- Adjustable, lockable heads
- Input voltage 5V-12VDC for 1W and 6V - 12VDC for 5W and 7W
- Clear PC lens and aluminum reflectors
- Canopy mounting holes designed to attach to electrical j-boxes
- Available in single head design - 1W / 5W / 7W heads
- Available in dual head design - 2x1W / 2x5W / 2x7W heads
- Damp location rated

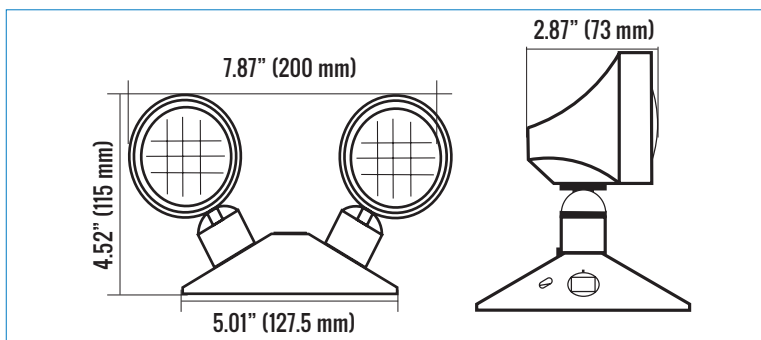
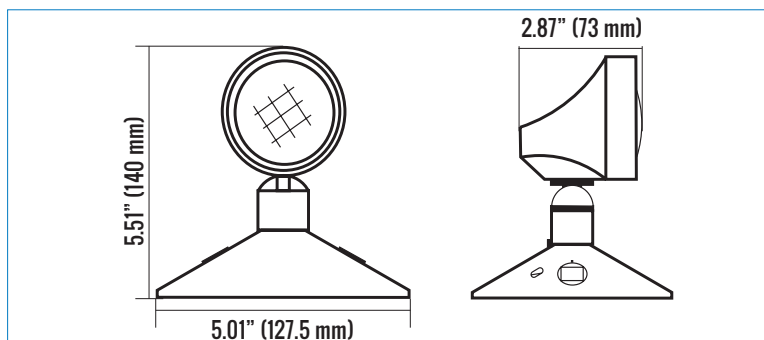

ADDITIONAL INFORMATION

INSTALLATION METHOD	FIXTURE COLOR	OPERATION TYPE
CEILING MOUNT/WALL MOUNT	WHITE	REMOTE HEADS OPERATE IN DC MODE

CATALOG #		TYPE
PROJECT		DATE
PREPARED BY		

PRODUCT CODE: ER210SWH-UD1 **LED SINGLE REMOTE HEAD EMERGENCY LIGHT 5V - 12VDC**

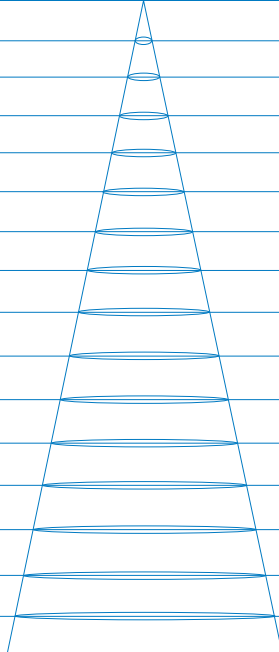
ILLUMINANCE (AT A DISTANCE) - FLUX OUT: 755.18LM			
3.28FT 1M	935.02LX		39.42CM
6.561FT 2M	233.76LX		78.84CM
9.84FT 3M	103.89LX		118.26CM
13.12FT 4M	58.44LX		157.68CM
16.40FT 5M	37.40LX		197.10CM
19.68FT 6M	25.97LX		236.52CM
22.96FT 7M	19.08LX		275.94CM
26.24FT 8M	14.61LX		315.36CM
29.52FT 9M	11.54LX		354.78CM
32.80FT 10M	9.35LX		394.20CM
36.08FT 11M	7.73LX		433.62CM
39.36FT 12M	6.49LX		473.04CM
42.65FT 13M	5.53LX		512.46CM
45.93FT 14M	4.77LX		551.88CM
49.21FT 15M	4.16LX		591.30CM
52.49FT 16M	3.65LX		630.72CM
HT	EAVG/EMAX	ANGLE: 22.30DEG	DIA

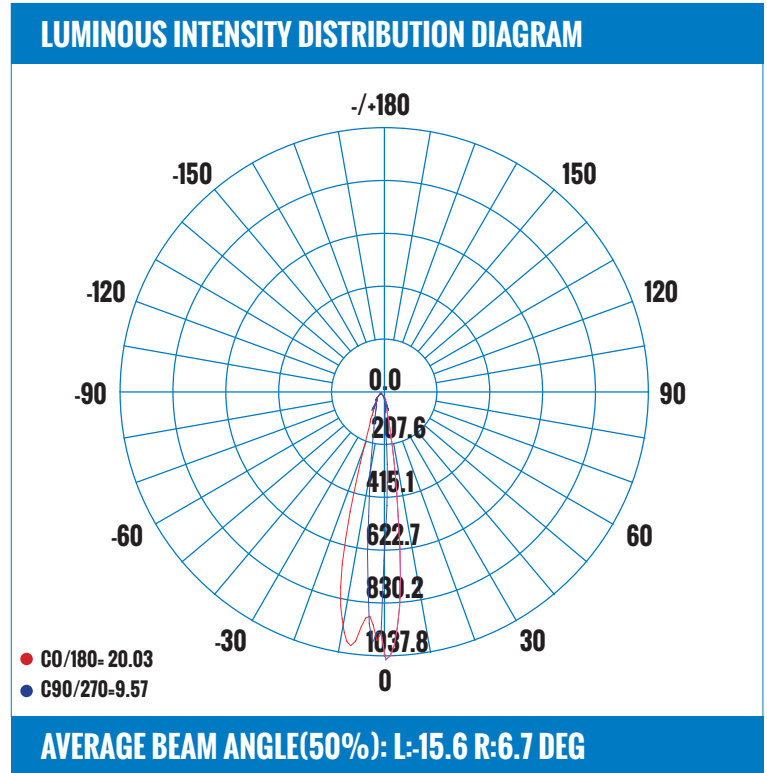

PRODUCT CODE: ER210DWH-UD2 **LED DOUBLE REMOTE HEAD EMERGENCY LIGHT 5V - 12VDC**

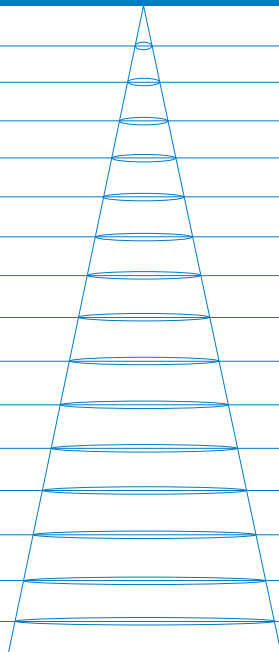
ILLUMINANCE (AT A DISTANCE) - FLUX OUT:			
3.28FT 1M	215.90LX		34.91CM
6.561FT 2M	53.98LX		69.81CM
9.84FT 3M	23.99LX		104.72CM
13.12FT 4M	13.49LX		139.62CM
16.40FT 5M	8.64LX		174.53CM
19.68FT 6M	6.00LX		209.43CM
22.96FT 7M	4.41LX		244.34CM
26.24FT 8M	3.37LX		279.24CM
29.52FT 9M	2.67LX		314.15CM
32.80FT 10M	2.16LX		349.06CM
36.08FT 11M	1.78LX		383.96CM
39.36FT 12M	1.50LX		418.87CM
42.65FT 13M	1.28LX		453.77CM
45.93FT 14M	1.10LX		488.68CM
49.21FT 15M	0.96LX		523.58CM
52.49FT 16M	0.84LX		558.49CM
HT	EAVG/EMAX	ANGLE: 19.80DEG	DIA

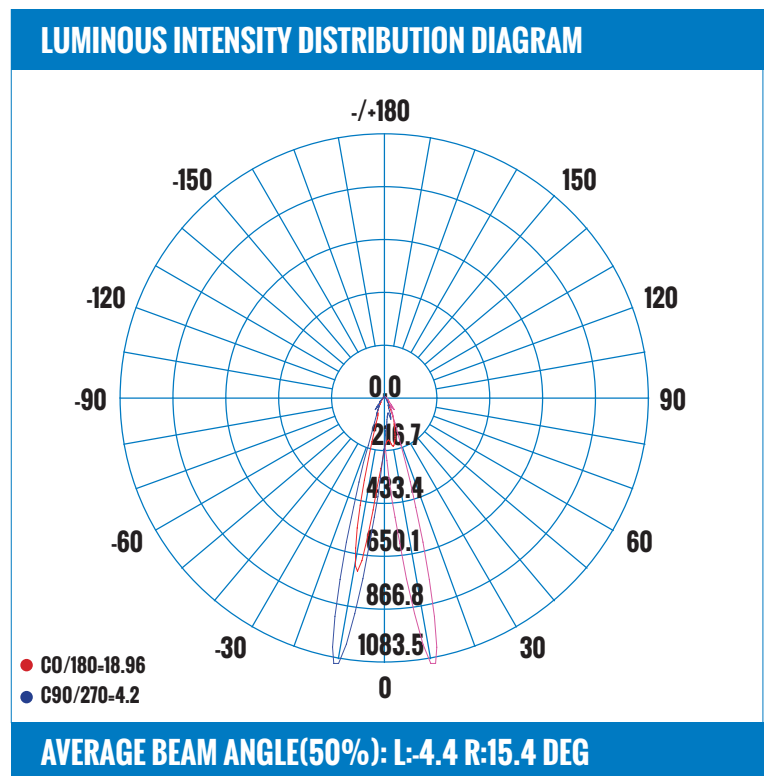

CATALOG #		TYPE
PROJECT		DATE
PREPARED BY		

PRODUCT CODE: ER250SWH-UD5 **LED SINGLE REMOTE HEAD EMERGENCY LIGHT 6V - 12VDC**

ILLUMINANCE (AT A DISTANCE) - FLUX OUT: 755.18LM

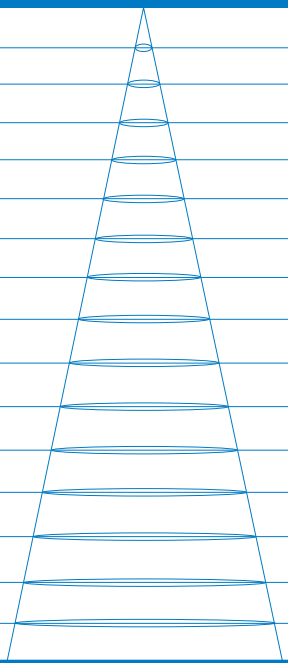
3.28FT 1M	559.92LX		58.11CM
6.561FT 2M	139.98LX		116.21CM
9.84FT 3M	62.21LX		174.32CM
13.12FT 4M	35LX		232.42CM
16.40FT 5M	22.40LX		290.53CM
19.68FT 6M	15.55LX		348.63CM
22.96FT 7M	11.43LX		406.74CM
26.24FT 8M	8.75LX		464.84CM
29.52FT 9M	6.91LX		522.95CM
32.80FT 10M	5.60LX		581.05CM
36.08FT 11M	4.63LX		639.16CM
39.33FT 12M	3.89LX		697.26CM
42.65FT 13M	3.31LX		755.37CM
45.93FT 14M	2.86LX		813.48CM
49.21FT 15M	2.49LX		871.58CM
52.49FT 16M	2.19LX		929.69CM
HT	EAVG/EMAX	ANGLE: 32.40DEG	DIA

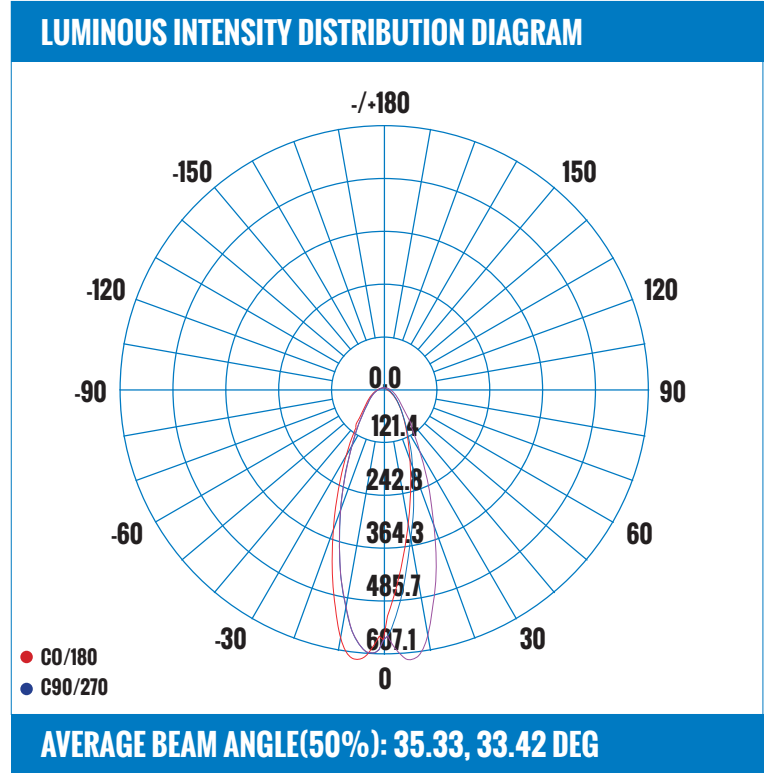

PRODUCT CODE: ER250DWH-UD10 **LED DOUBLE REMOTE HEAD EMERGENCY LIGHT 6V - 12VDC**

ILLUMINANCE (AT A DISTANCE) - FLUX OUT: 377.44LM

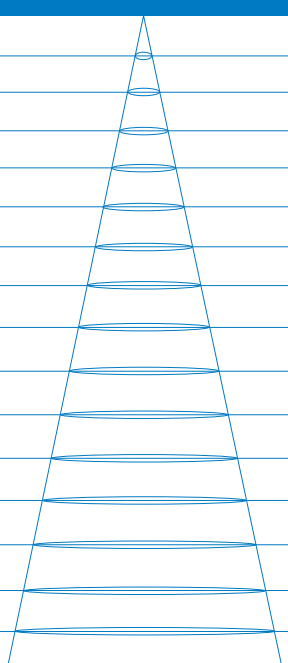
3.28FT 1M	1031.25LX		70.23CM
6.561FT 2M	257.81LX		140.47CM
9.84FT 3M	114.58LX		210.70CM
13.12FT 4M	64.45LX		280.94CM
16.40FT 5M	41.25LX		351.17CM
19.68FT 6M	28.65LX		421.41CM
22.96FT 7M	21.05LX		491.64CM
26.24FT 8M	16.11LX		561.88CM
29.52FT 9M	12.73LX		632.11CM
32.80FT 10M	10.31LX		702.35CM
36.08FT 11M	8.52LX		772.58CM
39.33FT 12M	7.16LX		842.82CM
42.65FT 13M	6.10LX		913.05CM
45.93FT 14M	5.26LX		983.29CM
49.21FT 15M	4.58LX		1053.52CM
52.49FT 16M	4.03LX		1123.76CM
HT	EAVG/EMAX	ANGLE: 38.70DEG	DIA

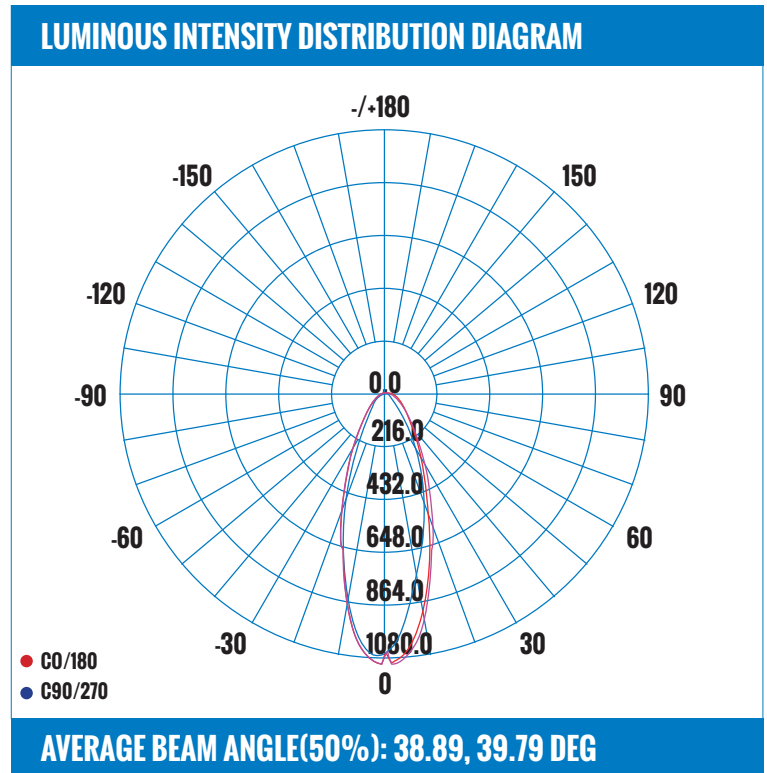

CATALOG #		TYPE
PROJECT		DATE
PREPARED BY		

PRODUCT CODE: ER270SWH-UD7 **LED SINGLE REMOTE HEAD EMERGENCY LIGHT 6V - 12VDC**

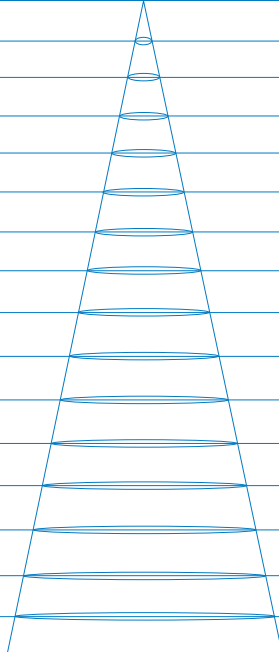
ILLUMINANCE (AT A DISTANCE) - FLUX OUT: 410.4LM			
3.28FT 1M	571.87LX		58.48CM
6.561FT 2M	142.97LX		116.97CM
9.84FT 3M	63.54LX		175.45CM
13.12FT 4M	35.74LX		233.94CM
16.40FT 5M	22.87LX		292.42CM
19.68FT 6M	15.89LX		350.90CM
22.96FT 7M	11.67LX		409.39CM
26.24FT 8M	8.94LX		467.87CM
29.52FT 9M	7.06LX		526.36CM
32.80FT 10M	5.72LX		584.84CM
36.08FT 11M	4.73LX		643.32CM
39.36FT 12M	3.97LX		701.81CM
42.65FT 13M	3.38LX		760.29CM
45.93FT 14M	2.92LX		818.78CM
49.21FT 15M	2.54LX		877.26CM
52.49FT 16M	2.23LX		935.75CM
HT	EAVG/EMAX	ANGLE: 32.60DEG	DIA

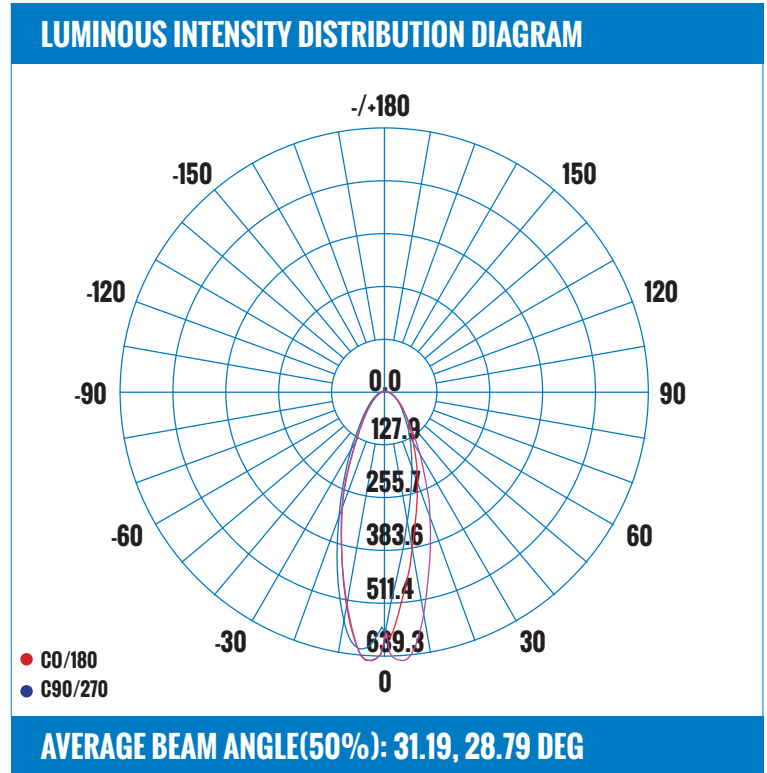

PRODUCT CODE: ER270DWH-UD14 **LED DOUBLE REMOTE HEAD EMERGENCY LIGHT 6V - 12VDC**

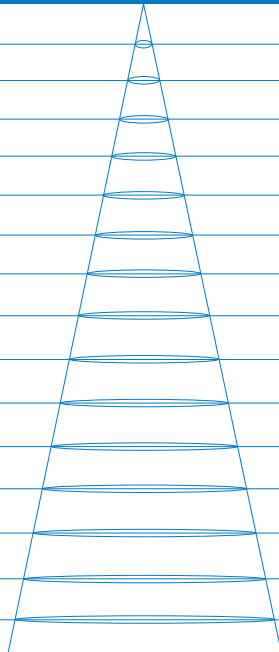
ILLUMINANCE (AT A DISTANCE) - FLUX OUT: 804.87LM			
3.28FT 1M	908.25LX		65.37CM
6.561FT 2M	227.06LX		130.74CM
9.84FT 3M	100.92LX		196.11CM
13.12FT 4M	56.77LX		261.48CM
16.40FT 5M	36.33LX		326.85CM
19.68FT 6M	25.23LX		392.22CM
22.96FT 7M	18.54LX		457.59CM
26.24FT 8M	14.19LX		522.96CM
29.52FT 9M	11.21LX		588.33CM
32.80FT 10M	9.08LX		653.70CM
36.08FT 11M	7.51LX		719.07CM
39.36FT 12M	6.31LX		784.44CM
42.65FT 13M	5.37LX		849.81CM
45.93FT 14M	4.63LX		915.18CM
49.21FT 15M	4.04LX		980.55CM
52.49FT 16M	3.55LX		1045.92CM
HT	EAVG/EMAX	ANGLE: 36.20DEG	DIA

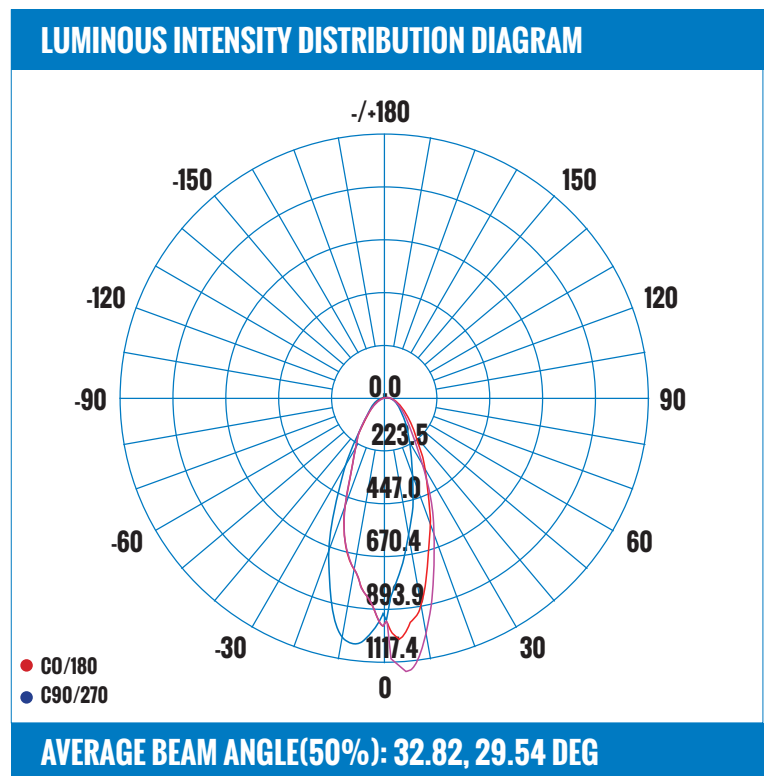

CATALOG #		TYPE
PROJECT		DATE
PREPARED BY		

PRODUCT CODE: ER210SWH-UD1 ER210DWH-UD2	LED SINGLE REMOTE HEAD EMERGENCY LIGHT 5V - 12VDC LED DOUBLE REMOTE HEAD EMERGENCY LIGHT 5V - 12VDC	
--	--	---

CERTIFICATIONS



PRODUCT CODE: ER250SWH-UD5 / ER270SWH-UD7 ER250DWH-UD10 / ER270DWH-UD14	LED SINGLE REMOTE HEAD EMERGENCY LIGHT 6V - 12VDC LED DOUBLE REMOTE HEAD EMERGENCY LIGHT 6V - 12VDC	
--	--	---

CERTIFICATIONS



ORDERING INFORMATION - ER SERIES

SERIES	MODEL	HEADS	COLOR	VOLTAGE	VOLTAGE TYPE	WATTAGE
E.G. ER	210	S	WH	U	D	1
ER - EMERGENCY	210 - MODEL	S - SINGLE	WH - WHITE	U - 5 - 12VDC	D - DC	1 - 1W
E.G. ER	210	D	WH	U	D	2
ER - EMERGENCY	210 - MODEL	D - DOUBLE	WH - WHITE	U - 5 - 12VDC	D - DC	2 - 2W
E.G. ER	250	S	WH	U	D	5
ER - EMERGENCY	250 - MODEL	S - SINGLE	WH - WHITE	U - 6 - 12VDC	D - DC	5 - 5W
E.G. ER	250	D	WH	U	D	10
ER - EMERGENCY	250 - MODEL	D - DOUBLE	WH - WHITE	U - 6 - 12VDC	D - DC	10 - 10W
E.G. ER	270	S	WH	U	D	7
ER - EMERGENCY	270 - MODEL	S - SINGLE	WH - WHITE	U - 6 - 12VDC	D - DC	7 - 7W
E.G. ER	270	D	WH	U	D	14
ER - EMERGENCY	270 - MODEL	D - DOUBLE	WH - WHITE	U - 6 - 12VDC	D - DC	14 - 14W

Head Office - 1850 Wilson Ave. - Toronto, ON - M9M 1A1 - Tel: 416.741.7336 - Fax: 416.741.9104

Toll Free: in Canada. 1.800.661.9610 - in USA. 1.888.762.5384 (SOCKETS4U)

www.etlin-daniels.com - For sales/service questions - sales@etlin.com