

NITE STAR II™

PROJECT:	
TYPE:	
CATALOG NUMBER:	
SOURCE:	
NOTES:	

CATALOG NUMBER LOGIC

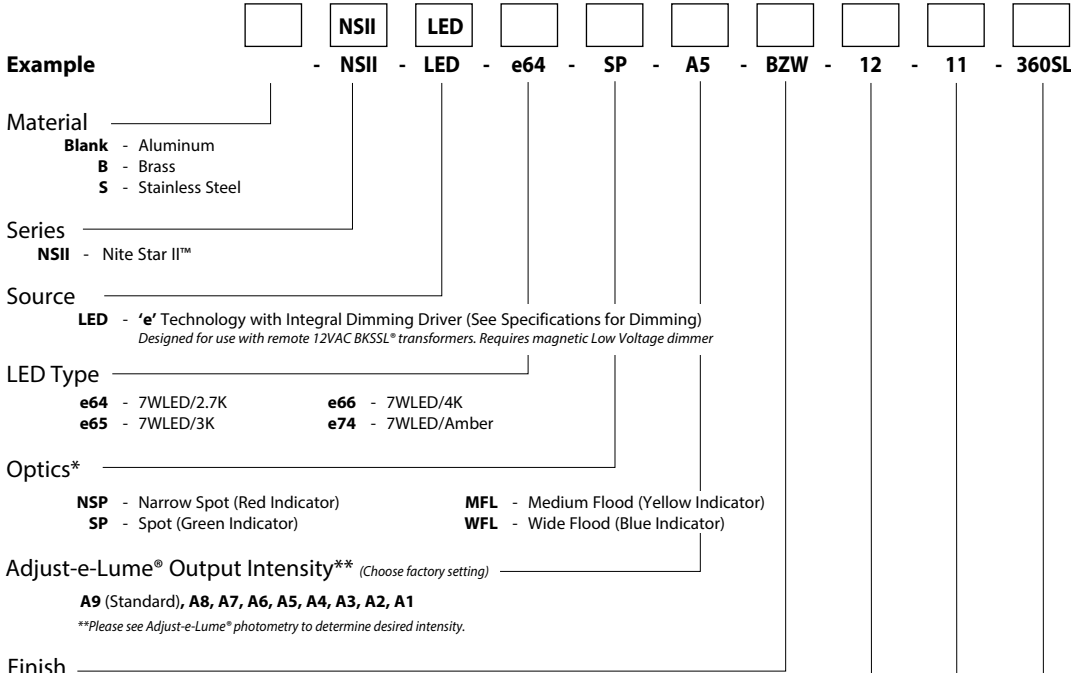

Aluminum Finish			Brass Finish		Premium Finish		
Powder Coat Color	Satin	Wrinkle	Machined	MAC	ABP Antique Brass Powder	CMG Cascade Mountain Granite	RMG Rocky Mountain Granite
Bronze	BZP	BZW	Polished	POL	AMG Aleutian Mountain Granite	CRI Cracked Ice	SDS Sonoran Desert Sandstone
Black	BLP	BLW	Mitique™	MIT	AQW Antique White	CRM Cream	SMG Sierra Mountain Granite
White (Gloss)	WHP	WHW	Stainless Finish		BCM Black Chrome	HUG Hunter Green	TXF Textured Forest
Aluminum	SAP	—	Machined	MAC	BGE Beige	MDS Mojave Desert Sandstone	WCP Weathered Copper
Verde	—	VER	Polished	POL	BPP Brown Patina Powder	NBP Natural Brass Powder	WIR Weathered Iron
			Brushed	BRU <small>Interior use only.</small>	CAP Clear Anodized Powder	OCF Old Copper	<i>Also available in RAL Finishes See submittal SUB-1439-00</i>

Lens Type
12 - Soft Focus Lens
13 - Rectilinear Lens

Shielding
11 - Honeycomb Baffle

Option
360SL - 360SL™ Rotational Knuckle Mounting System

DRIVER DATA	Input Volts	InRush Current	Operating Current	Dimmable	Operation Ambient Temperature
	12VAC/DC 50/60Hz	250mA (non-dimmed)	700mA	Magnetic Low Voltage Dimmer	-10°F-130°F

LM79 DATA

BK No.	CCT (Typ.)	Input Watts (Typ.)	CRI (Typ.)
e64	2700K	7.0	80
e65	3000K	7.0	80
e66	4000K	7.0	80
e74	Amber (590nm)	7.0	~

L70 DATA

Minimum Rated Life (hrs.) 70% of initial lumens(L70)
50,000
50,000
50,000
50,000

* OPTICAL DATA

Beam Type	Angle	e66 CBCP	Visual Indicator
Narrow Spot	13°	6889	Red Dot
Spot	15°	5225	Green Dot
Medium Flood	23°	1984	Yellow Dot
Wide Flood	31°	1300	Blue Dot

B-K LIGHTING	40429 Brickyard Drive • Madera, CA 93636 • USA 559.438.5800 • FAX 559.438.5900 www.bklighting.com • info@bklighting.com	RELEASED 10-24-18	DRAWING NUMBER SUB-2192-00
---------------------	---	----------------------	-------------------------------

THIS DOCUMENT CONTAINS PROPRIETARY INFORMATION OF B-K LIGHTING, INC. AND ITS RECEIPT OR POSSESSION DOES NOT CONVEY ANY RIGHTS TO REPRODUCE, DISCLOSE ITS CONTENTS, OR TO MANUFACTURE, USE OR SELL ANYTHING IT MAY DESCRIBE. REPRODUCTION, DISCLOSURE OR USE WITHOUT SPECIFIC WRITTEN AUTHORIZATION OF B-K LIGHTING, INC. IS STRICTLY FORBIDDEN.

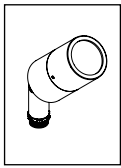

BKSSL
SOLID STATE LIGHTING

the power of dimming with **adjust-e-lume** TECHNOLOGY

NITE STAR II™

PROJECT:	
TYPE:	

SIDE VIEW

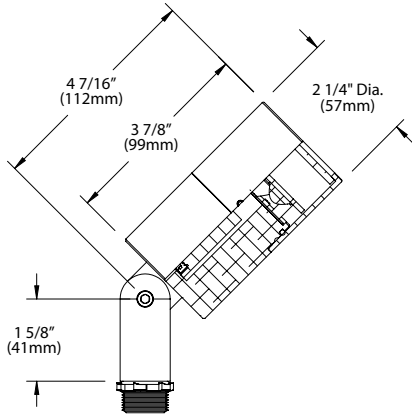

SIDE VIEW **adjust-e-lume** TECHNOLOGY

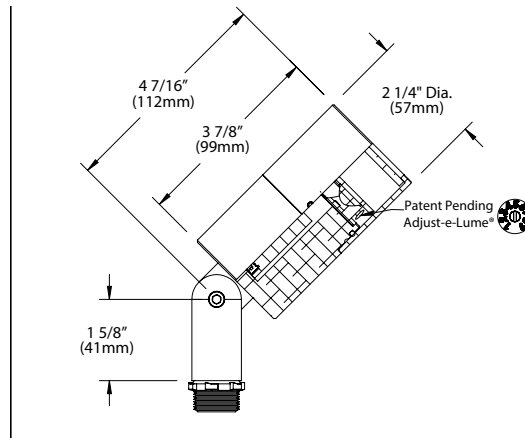

360SL™

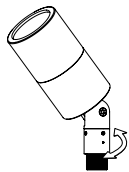

Horizontal Rotation
(Optional 360SL™ Knuckle)

Accessories (Configure separately)

All dimensions indicated on this submittal are nominal. Contact Technical Sales if you require more stringent specifications.

Mounting:

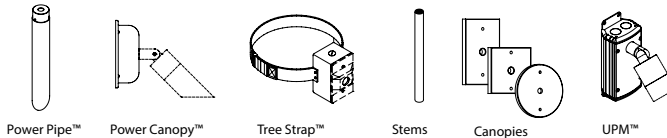

Remote Transformers:

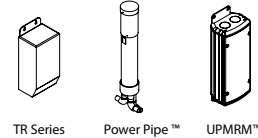

SPECIFICATIONS

GreenSource Initiative™

Metal and packaging components are made from recycled materials. Manufactured using renewable solar energy, produced on site. Returnable to manufacturer at end of life to ensure cradle-to-cradle handling. Packaging contains no chlorofluorocarbons (CFC's). Use of this product may qualify for GreenSource efficacy and recycling rebate(s). Consult www.bklighting.com/greensource for program requirements.

Materials

Furnished in Copper-Free Aluminum (Type 6061-T6), Brass (Type 360) or Stainless Steel (Type 304).

Body

Fully machined from solid billet. Unibody design provides enclosed, water-proof wireway and integral heat sink for maximum component life. Integral knuckle for maximum mechanical strength. High temperature, silicone 'O' Ring provides water-tight seal.

Knuckle

The LOCK™ (Locking 'O' Ring Compression Knuckle) is comprised of two components. The first is integral to the body and features an interior, machined taper. The second is machined from solid billet and features a second, reverse angle taper. The resultant mechanical taper-lock allows a full 180° vertical adjustment without the use of serrated teeth, which inherently limit aiming. High temperature, silicone 'O' Ring provides water-tight seal and compressive resistance to maintain fixture position. Design withstands 73 lb. static load prior to movement to ensure decades of optical alignment. 1/2" pipe thread for mounting.

Optional 360SL™ additionally provides biaxial source control with 360° horizontal rotation in addition to vertical adjustment.

Cap

Fully machined. 1" deep cutoff with flush mounted lens. Accommodates up to (2) lens or louver media.

Lens

Shock resistant, tempered, glass lens is factory adhered to fixture cap and provides hermetically sealed optical compartment. Specify soft focus (#12) or rectilinear (#13) lens.

BKSSL®

Integrated solid state system with 'e' technology is scalable for field upgrade. Modular design with electrical quick disconnects permit field maintenance. High power, forward throw source complies with ANSI C78.377 binning requirements. Exceeds ENERGY STAR® lumen maintenance requirements. LM-80 certified components.

Integral, constant current driver. 12VAC/VDC input. 50/60Hz. Proprietary input control scheme achieves power factor correction and eliminates inrush current. Output, over-voltage, open-circuit, and short circuit protected. Inrush current limited to <1A (non-dimming). Conforms to Safety Std. C22.2 No. 250.13-12.

Dimming

Line voltage dimmable via magnetic low voltage dimmer. For use with low voltage dimmer with dedicated neutral conductor. For purposes of dimming: Remote magnetic transformer with BKSSL® Power of 'e' technology loads should be loaded to 25% of the transformer VA (watts) rated value.

Adjust-e-Lume®

Integral electronics allows dynamic lumen response at the individual fixture. Indexed (100% to 25% nom.) lumen output. Maintains output at desired level or may be changed as conditions require. Specify factory preset output intensity.

Optics

Interchangeable OPTIKIT™ modules permit field changes to optical distribution. Color-coded for easy reference: Narrow Spot (NSP) = Red. Spot (SP) = Green. Medium Flood (MFL) = Yellow. Wide Flood (WFL) = Blue.

Remote Transformer

For use with 12VAC BKSSL remote transformer or magnetic transformers only. B-K Lighting cannot guarantee performance with third party manufacturers' transformers.

Wiring

XLPE, 18GA, 150C, 600V, rated and certified to UL3321.

Hardware

Tamper-resistant, stainless steel hardware. LOCK™ aiming screw is additionally black oxide treated for additional corrosion resistance.

Finish

StarGuard®, our exclusive RoHs compliant, 15 stage chromate-free process cleans and conversion coats aluminum components prior to application of Class 'A' TGIC polyester powder coating. Brass components are available in powder coat or handcrafted metal finish. Stainless steel components are available in handcrafted metal finish. (Brushed finish for interior use only).

Warranty

5 year limited warranty.

Certification and Listing

ITL tested to IESNA LM-79. UL Listed. Certified to CAN/CSA /ANSI Standards. RoHs compliant. Suitable for indoor or outdoor use. Suitable for use in wet locations. Suitable for installation within 4' of the ground. IP66 Rated. Made in USA.



*Energy Star is a registered trademark of the United States Environmental Protection Agency.

B-K LIGHTING

40429 Brickyard Drive • Madera, CA 93636 • USA
559.438.5800 • FAX 559.438.5900
www.bklighting.com • info@bklighting.com

RELEASED
10-24-18

DRAWING NUMBER
SUB-2192-00