

PIR Dimmer DNA042CPU1-600 User Instructions

Suitable for DIMMABLE LED, CFL, Incandescent and halogen bulbs

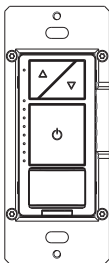

Product Model	DNA042CPU1-600
Voltage	120V~
Frequency	60Hz
Wattage	600W
Load Range	Incandescent:15W-600W
	LED/CFL:3W-200W
Dimming Method	Phase-cut
Working Environment	Temperature: 0°C - 40°C
	Humidity: 10% R.H. - 90% R.H.
Model Size	105 mm×44 mm×35mm (L×W×H)

WARNINGS AND CAUTIONS

- 1.1 To avoid risk of fire and electrical shock, the dimmer should be installed in accordance with appropriate electrical codes and regulations.
- 1.2 This product should be use with air switch.
- 1.3 Turn power off at circuit breaker or fuse and test that power is off before installing.
- 1.4 After install the dimmer, it is recommended to set the minimum brightness level to make bulbs turn on immediately.
- 1.5 If you are unsure about any part of these instructions, consult a licensed electrician.
- 1.6 To reduce the risk of overheating and possible damage to other equipment, do not install to control a receptacle, a motor-operated appliance or a transformer-supplied appliance.

- 1.7 Use with compatible dimmable LED, dimmable CFL bulbs, Incandescent and halogen bulbs only
- 1.8 When multiple bulbs are used with one dimmer DO NOT mix bulb types. All bulbs shall be either LED, CFL or incandescent. Using the same model of each bulb will enhance dimmer performance.
- 1.9 Optimum installation height: 3.94ft.

FCC Information

This device complies with part 15 of the FCC Rules. Operation is subject to the following two conditions:
(1) This device may not cause harmful interference, and (2) this device must accept any interference received, including interference that may cause undesired operation.

Changes or modifications not expressly approved by the party responsible for compliance could void the user's authority to operate the equipment.

NOTE: This equipment has been tested and found to comply with the limits for a Class B digital device, pursuant to part 15 of the FCC Rules. These limits are designed to provide reasonable protection against harmful interference in a residential installation. This equipment generates, uses and can radiate radio frequency energy and, if not installed and used in accordance with the instructions, may cause harmful interference to radio communications. However, there is no guarantee that interference will not occur in a particular installation. If this equipment does cause harmful interference to radio or television reception, which can be determined by turning the equipment off and on, the user is encouraged to try to correct the interference by one or more of the following measures:

- Reorient or relocate the receiving antenna.
- Increase the separation between the equipment and receiver.
- Connect the equipment into an outlet on a circuit different from that to which the receiver is connected.
- Consult the dealer or an experienced radio/TV technician for help.

Functional Instructions

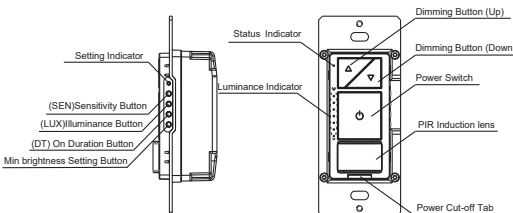

Short press: Within 0.5s
Long press: Over 0.5s
Continuous short press: Each interval of short press should within 1s

Note: During the PIR switch detect automatically, The PIR will start to detect after 10s of manually turning on and off the light.

Factory default

Setting on the max. brightness when turn on.
Autonomously PIR detects/High PIR sensitivity/High PIR illumination/On duration time 1min.

PIR Automatic Detection Or Manual Control

Long press the power button can switching.

PIR Automatic Detection:

The status indicator will turn to white light then flash two times.

Manual Control:

The status indicator will turn to red light then flash two times.

Manual Control

Power Switch

Turn on: Short press the power switch once and the status indicator keep white light.

Turn off: Short press the power switch once and the status indicator keep red light.

Min. brightness setting: Turn the light to ideal min.brightness and short press the power button for 6 times when in ON.

Max. brightness setting: Turn the light to ideal max. brightness and short press the power button for 8 times when in ON.

Clear min. and max. brightness setting: Continuous short press the power button 9 times when in ON.

Restore factory setting: Short press the power button for 10 times, the status indicator blinks white 3 times.

Dimming Button (UP)

Quick to min brightness:

Short press the dimming button twice when in on/off.

Short press the dimming button(up) once can increase a level of brightness when in ON status.

Long press the dimming button(up) can increase the brightness continuously until release or reach the max. brightness.

Dimming Button (Down)

Dimming to min. brightness quickly:Short press the dimming button 2 times continuously when the light is in - ON/OFF status.

Decrease the brightness: Short press the dimming button once can decrease a level of brightness when the light is in ON status.

Decrease the brightness continuously:Long press the dimming button can continuous to decrease the brightness until release or reach the minimum brightness.

PIR Automatic Detection

Note: Turn manually off the lamp and wait about 10s before PIR automatic detection work under mode of PIR automatic detection.

PIR detects the signal of human body can automatically turn on the light, and status indicator keep white light.

The lamp will be turned off automatically and the status indicator will keep red when on duration time is reached.

PIR Sensitivity Setting

(SEN: PIR Sensitivity Setting button) PIR Sensitivity has low, middle and high level:short press the PIR Sensitivity Setting button to set the indicator (No operation for more than 5 seconds, the indicator will light off).

- ① low:The red light on;
- ② Middle: The green light on;
- ③ High:The blue light on(default setting).

PIR Illuminance Setting

(LUX: PIR illuminance Setting button)PIR illuminance has low, middle and high level:short press the PIR illuminance Setting button to set the indicator (No operation for more than 5 seconds,the indicator will light off).

- ① low:The red light on;
- ② Middle: The green light on;
- ③ High:The blue light on(default setting).

Lamp Duration Setting

(DT: Setting button of lighting time) the lighting time has 4 mode:1min- 5min- 15min- and light control to choose: short press the Setting button of lighting time to set the indicator to indicate (No operation for more than 5 seconds, the indicator will light off).

- ① 1min:The red light on(default setting);
- ② 5min:The green light on
- ③ 15min:The blue light on
- ④ Light control mode: The yellow light on.

Light-control Mode

Short press the DT button until the status indicator turn to yellow when in PIR automatic detection.

Turn on: When the ambient illumination is detected to be lower than the setting,the status indicator keeps the white light on.

When the ambient illumination is detected higher than the setting,the status indicator keep red light on.

PIR illuminance Setting

(LUX: PIR illuminance Setting button)PIR illuminance has low, middle and high level:short press the PIR illuminance Setting button to set the indicator (No operation for more than 5 seconds, setting indicator will light off).

- ① low:The red light on;
- ② Middle: The green light on;
- ③ High:The blue light on(default setting)

Note:

Light control mode: When the ambient illumination is lower than the setting,the load light will be on; When the ambient illumination is higher than the setting,the load light will be off.

Power cut-off Tab

Put in the power cut-off tab to power on.
Put out the power cut-off tab to power off.

Luminance Indicator

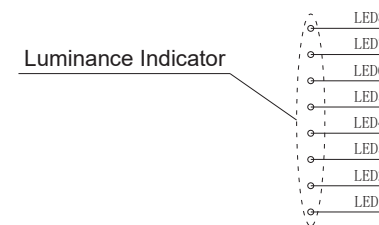

Luminance indicator

Item	Luminance Level	Luminance Indicator
1	Luminance 1~2	LED 1 normally on
2	Luminance 3~4	LED 1~LED 2 normally on
3	Luminance 5~6	LED 1~LED 3 normally on
4	Luminance 7~8	LED 1~LED 4 normally on
5	Luminance 9~10	LED 1~LED 5 normally on
6	Luminance 11~12	LED 1~LED 6 normally on
7	Luminance 13~14	LED 1~LED 7 normally on
8	Luminance 15~16	LED 1~LED 8 normally on

Accessories

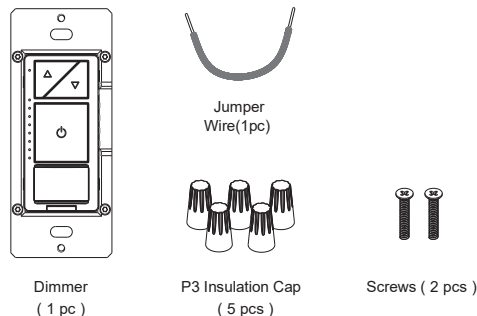

Tools needed to install

Ø5mm Cross screwdriver	Test Pencil
Electrical tape	Pliers
The Electrician Knife	Ruler

4. Installation

4.1 ⚠️ **WARNING:** To avoid fire and electrical shock, turn off power at circuit breaker or fuse and test that power is off before wiring.

4.2 Remove the screws installed on the existing panel and switch, carefully pull out the switch from the wall box, identify and remove the power cord attached to the switch, and the switch, do not remove the power cord detached from the switch. (This step is not required for new configuration installation.)

4.3 Identify Location 1 cord type

Note: If the power cord in the wall box is different from the following layouts, please consult an electrician.

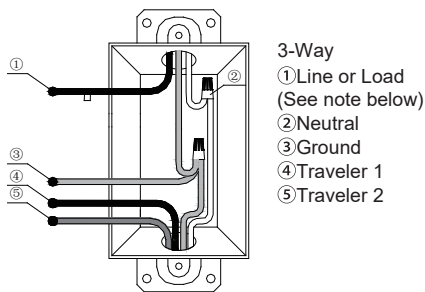
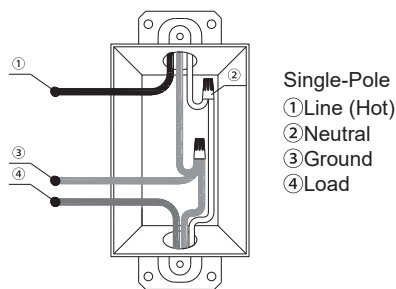

IMPORTANT Please note that for 3-way application, there is a power cord from the original switch be a different color (Black) or marked Common. Finding this power cord from both the dimmer's junction box and 3-way junction box, then marking it as common (live or load).

4.4 Typical wiring application

4.4.1 Single-Pole

Connection way 1

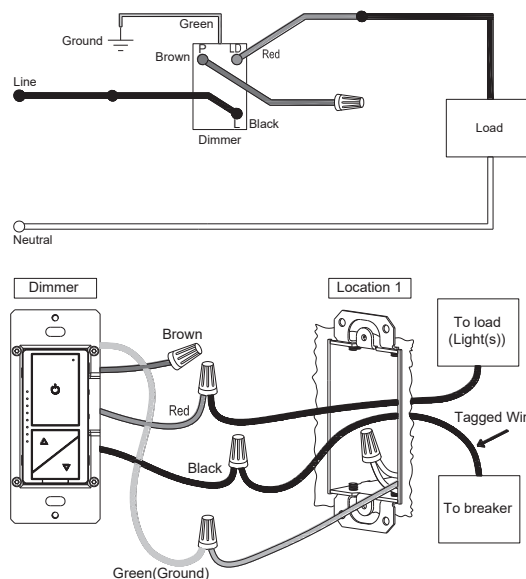

Location 1 Connection:

- Connect the green wire on the dimmer with the green or bare copper ground wire on the wall box, and tighten it with the P3 wiring nut.
- Connect the black wire to the live wire of circuit breaker, and tighten it with the P3 wiring nut.
- Connect the red wire on the dimmer with the load wire, and tighten it with the P3 wiring nut.
- Screw the remaining brown wire on the dimmer with the P3 wiring nut to protect it.

4.4.2 3-Way

3-Way (3-Way Switch)

Note: When in 3-Way connection, marking the two ends of Traveler 1 and Traveler 2 cables clearly at Location 1 and Location 2 to prevent connection errors.

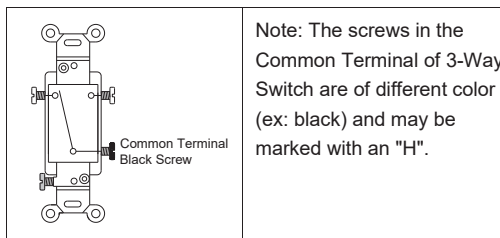

Dimmer Line Side

Connection way 2

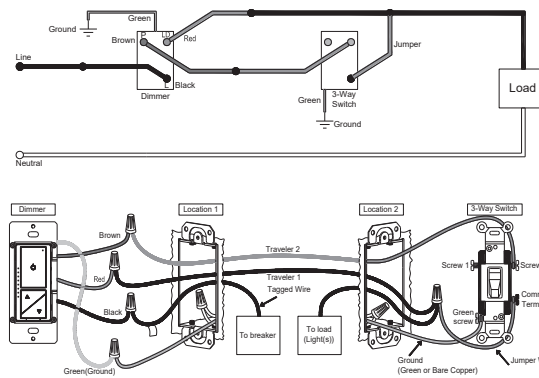

Location 1 Connection:

- Connect the green wire on the dimmer with the green or bare copper ground wire on the wall box and tighten it with p3 wiring nut.
- Connect the black wire on the dimmer to the labeled wire (the live wire of circuit breaker), and tighten it with p3 wire nut.
- Connect the brown wire on the dimmer to Traveler 2 and tighten it with p3 wiring nut.
- Connect the red wire on the dimmer to Traveler 1 and tighten it with p3 wiring nut.

Location 2 Connection:

- Connect the Traveler 2 to Screw 1 or Screw 2 on the 3-way Switch.
- Connect the 3-way Switch's Common Terminal to the Jumper wire. Traveler 1 is connected to the Jumper wire and load wire of circuit breaker and tighten it with p3 wiring nut.

Dimmer Load Side

Connection way 3

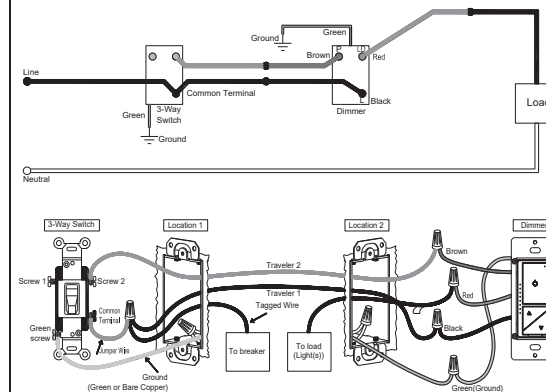

Location 1 Connection:

- Connect the Traveler 2 to Screw 1 or Screw 2 on the way Switch.
- Connect the 3-way Switch's Common Terminal to the Jumper wire. Traveler 1 is connected to the Jumper wire and the live wire of circuit breaker, and tighten it with p3 wiring nut.

Location 2 Connection:

- Connect the green wire on the dimmer to the green or bare copper ground wire on the wall box, and tighten it with p3 wiring nut.
- Connect the black wire on the dimmer to Traveler 1 and tighten with p3 wiring nut.
- Connect the brown wire on the dimmer to Traveler 2 and tighten with p3 wiring nut.
- Connect the red wire on the dimmer with the labeled wire (Load Wire) and tighten with p3 wiring nut.

3-Way (Toggle Switch)

Note: When in 3-Way connection, marking the two ends of Traveler 1 and Traveler 2 cables clearly at Location 1 and Location 2 to prevent connection errors.

Dimmer Line Side

Connection way 4

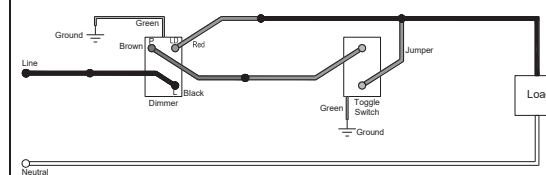

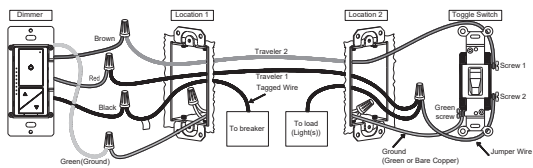

Location 1 Connection:

- Connect the green wire on the dimmer to the green or bare copper ground wire on the wall box, and tighten it with p3 wiring nut.
- Connect the black wire to the labeled wire(live wire of circuit breaker),and tighten it with the P3 wiring nut.
- Connect the brown wire on the dimmer to Traveler 2 and tighten it with p3 wiring nut.
- Connect the red wire on the dimmer to Traveler 1 and tighten it with p3 wiring nut.

Location 2 Connection:

- Connect the Traveler 2 to Screw 1 on the Toggle Switch.
- Connect the Screw 2 on the Toggle Switch to the Jumper wire. Traveler 1 is connected to the Jumper wire and the Load Wire, tighten it with p3 wiring nut.

Dimmer Load Side

Connection way 5

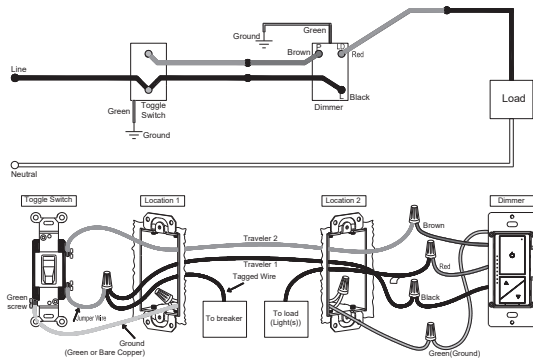

Location 1 Connection:

- Connect the Traveler 2 to Screw 1 on the Toggle Switch.
- Connect the Screw 2 on the Toggle Switch to the Jumper wire. Traveler 1 is connected to the Jumper wire and the live Wire of circuit breaker, tighten it with p3 wiring nut.

Location 2 Connection:

- Connect the green wire on the dimmer to the green or bare copper ground wire on the wall box, and tighten with p3 wiring nut.
- Connect the black wire on the dimmer to Traveler 1 and tighten it with p3 wiring nut.

- Connect the brown wire on the dimmer to Traveler 2 and tighten it with p3 wiring nut.
- Connect the red wire on the dimmer to the labeled wire(Load Wire) and tighten it with p3 wiring nut.

4.5.1 Installing dimmer

- Carefully position all wires inside the wall-box, leaving enough space to insert the dimmer. Secure the dimmer with the provided mounting screws.

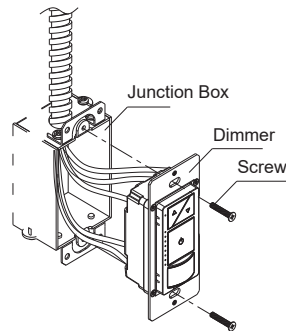

4.5.2 Install panel

4.5.2a split panel

- Installing the panel base on the dimmer and tighten with the screws.

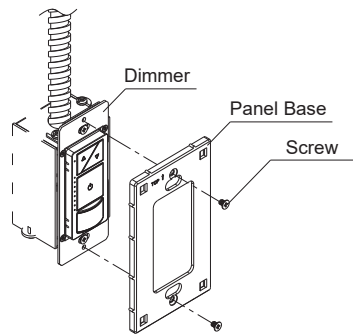

- Put the panel and panel base together, press gently to make sure it is be installed firmly.

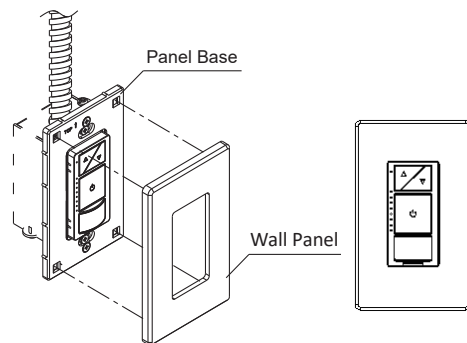

4.5.2b Integrated panel

- Installing the panel on the dimmer and tighten with the screws.

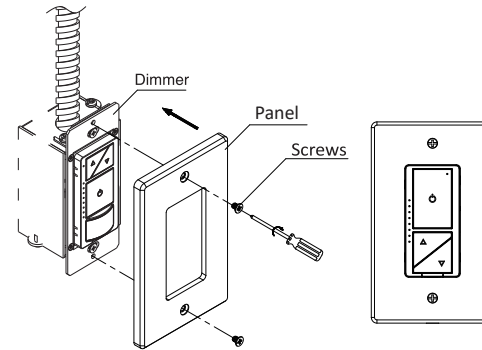

5. User Instructions

Function Declaration

Short press: Within 0.5s
 Long press: Over 0.5s
 Continuous short press:Each interval of short press should within 1s

Function	Operation
Factory default setting	<ul style="list-style-type: none"> • The light is on maximum brightness status. • PIR automatic detection; high PIR sensitivity, high PIR illumination, 1min lighting time.
PIR automatic detection and manual control to toggle	<ul style="list-style-type: none"> • Long press the power button to toggle; when PIR detect automatically , the white light flashes 2 times; when in manual control, the red light flashes 2 times.
Manual control	<ul style="list-style-type: none"> • Power button • Turn on the light: When the light is off, short press the power button once, the status indicator lights white constantly. • Turn off the light: When the light is on, short press the power button once, the status indicator lights red constantly. • Min. brightness setting:Turn the light to ideal min.brightness when the light is on,then short press the power button for 6 times. • Max. brightness setting:Turn the light to ideal max.brightness when the light is on,then short press the power button for 8 times. • Clear min.and max. brightness Setting: Continuous short press the power button 9 times when the light is on. • Restore to factory setting: Short press the power button for 10 times, the status indicator blinks white 3 times .

PIR automatic detection	<ul style="list-style-type: none"> • Dimming Button (UP) • Dimming to max. brightness quickly: Short press the dimming button 2 times continuously when the light is in - ON/OFF status. • Increase the brightness: Short press the dimming button once can increase a level of brightness when the light is in ON status. Increase the brightness continuously:Long press the dimming button can continuous to increase the brightness until release or reach the maximum brightness. 	
	<ul style="list-style-type: none"> • Dimming Button (Down) • Dimming to min. brightness quickly:Short press the dimming button 2 times continuously when the light is in - ON/OFF status. • Decrease the brightness: Short press the dimming button once can decrease a level of brightness when the light is in ON status. • Decrease the brightness continuously:Long press the dimming button can continuous to decrease the brightness until release or reach the minimum brightness. 	
	<ul style="list-style-type: none"> • After the PIR detects the infrared signal of human body, the light will be turned on automatically and the status indicator lights white constantly; after reaching to the light setting time,the light will be turned off automatically and the status indicator lights red constantly. 	
	<ul style="list-style-type: none"> • PIR Sensitivity Setting • (SEN:PIR Sensitivity Setting button) PIR Sensitivity has low, middle and high level: short press the PIR Sensitivity Setting button to set the indicator to indicate (No operation for more than 5s, indicator 	<ul style="list-style-type: none"> ① low:The red light on; ② Middle:The green light on; ③ High:The blue light on(default setting).
	<ul style="list-style-type: none"> • PIR illumination Setting • (LUX PIR illumination Setting button)PIR illumination has low, middle and high level: short press the PIR illumination Setting button to set the indicator to indicate (No operation for more than 5 seconds, setting indicator will light off). 	<ul style="list-style-type: none"> ① low:The red light on; ② Middle: The green light on; ③ High:The blue light on(default setting).

	<ul style="list-style-type: none"> Lighting time setting (DT: lighting time setting button) The lighting time have 1min、5min、15min and light-control mode to choose:short press the lighting time Setting button to set the indicator to indicate (No operation for more than 5 seconds, setting indicator will light off). 	<ul style="list-style-type: none"> ① 1min:The red light on(default setting); ② 5min:The green light on; ③ 15min:The blue light on; ④ Light-control:The yellow light on;
--	---	---

Light-control mode	<ul style="list-style-type: none"> Short press the DT button(lighting time Setting button) until the setting indicator turning to yellow when in PIR automatic detection mode. Turn on: When the ambient illumination is detected to be lower than the setting, the status indicator keeps the white light on. When the ambient illumination is detected higher than the setting, the status indicator keeps red light on.
--------------------	---

	<ul style="list-style-type: none"> PIR illuminance setting (LUX: PIR illuminance Setting button)PIR illuminance has low, middle and high level: short press the PIR illuminance Setting button to set the indicator to indicate (No operation for more than 5 seconds, the setting indicator will light off). 	<ul style="list-style-type: none"> ① low:The red light on; ② Middle:The green light on; ③ High:The blue light on(default setting).
--	---	---

Power on/off	<ul style="list-style-type: none"> Power on: Insert the power cut-off switch. Power off: pull out the power cut-off switch.
--------------	---

Detection Zone

Optimum mounting height:3.94ft.

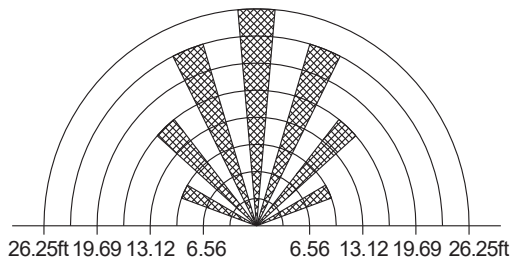

Max Horizontal detection range

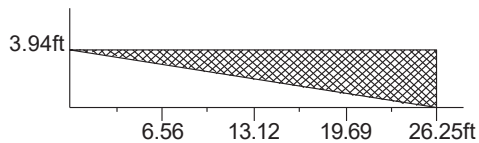

Max Vertical detection range

Troubleshooting

Problems	Possible Cause	Solution
Lights flickering	Bad connection	Reconnect and Connect the wires.
	Mixed use different types of lights, interference, resulting in flickering	Try the same type again.
	abnormal	Pull the power cut-off button out, cut off the electricity. Then try again.
LED and CFL flickers at low end of dimming range.	Bad compatibility	Turn up lamp minimum brightness properly.
Lights can't be turned on	Circuit breaker has tripped	Turn power on.
	Fuse burn out	Change fuse.
	Lamp burned out	Change lamp.
	Bad connection	Check the connection.
Lights out of control	Abnormal	Pull the power cut-off button out, cut off the electricity. Then try again.