

MLE30-12DC-UD

Class 2 Electronic UNIV 5 in 1 dimming
Outdoor Black Powder Coated Steel Enclosure
Single Circuit: **12VDC 800Hz**
Total Wattage: **30W max**
Input Voltage: **100-277V 50/60Hz**

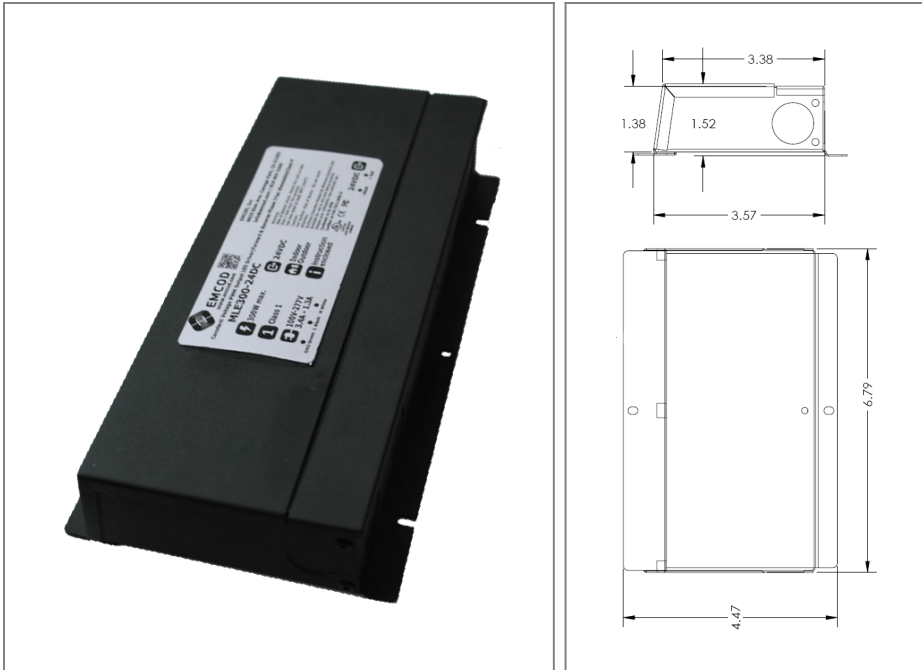

Conforms to UL STD. 8750 and 1310
Certified to CSA
STD. C22.2 No 250.0
model MLE30-12DC-UD



Transformer

Dimmable with triac forward and reverse phase, 0/1-10V , resistor, PWM
Input leads are 18AWG 600V
Output leads are 16AWG 300V
Leads max. operational temperature is 105°C

Housing

The actual transformer 30W is encapsulated in the enclosure
The enclosure is Black Powder Coated Steel, NEMA 3R rated
Wiring compartment has 6 knockouts sizes for 3/8 inch screw cable connectors
Enclosure Temperature does not exceed 70°C at 45°C ambient and fully loaded
Dimensions (inch): H = 4.47, W = 6.79, D = 1.38
Weight (LBs): 1.8

Electrical Parameters

Input Voltage:	100-277V 50/60Hz
Max. input current at full load:	0.3A
Output voltage without load:	12.1VDC
Output voltage fully loaded:	12VDC
Max. Total Wattage:	30W
Max. Output Current:	2.5A
Efficiency:	87%
Load regulation:	1%
Ripple:	5%

