

# wall heater

**WHF**  
SERIES

## FAN-FORCED / BETTER

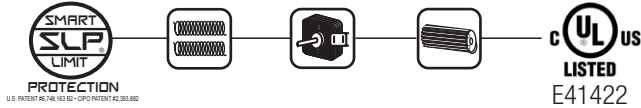

### FEATURES:

- Smart Limit Protection®
  - Dual Open-Coil Element
  - C-Frame Motor
  - Squirrel Cage Blower
  - Quiet
- Dual limit controls
  - Manual reset limits
  - Inlet and outlet sensing
  - Dual wattage
  - 20 gauge powder-coated grille with contemporary die-formed round corners
  - Standard color: bright white
  - 20 gauge electrogalvanized steel recess can with QuickSet™ stop on side
  - Factory installed groundwire approved for direct contact with building insulation.

### OPTIONS:

- 1-Pole or 2-Pole unit-mount thermostat 45°- 80°F operating range
- Thermostat fits through louver
- Retrofit grille
- Surface wall box
- Color: almond (-A)



### The WHF heater provides

extreme value by combining an open-coil wire element and a tangential blower. This makes it a relatively quiet heater without the added cost of a high mass element like the **Pic-A-Watt®**.

It is commonly used as the first upgrade in apartment construction and is an excellent choice for a bathroom heater because of the instant heat from the wire element.

This heater mounts horizontally and produces 70CFM.

Typically the thermostat control is remote wall-mounted but a built-in thermostat is optional. For best control use an electronic thermostat.



## ENGINEERING SPECIFICATIONS:

Contractor shall supply and install WHF Series wall-mounted forced-air electric heaters manufactured by King Electrical Mfg. Company. Heaters shall be of the wattage and voltage as indicated on the plans.

**Ratings:** Heaters shall be available in wattages of 500 to 2,400 at 120, 208, or 240 Volts.

**Blower and Motor:** A tangential cylindrical blower, delivering 70 CFM, shall be driven by a shaded pole, permanently lubricated, C-frame type motor with impedance protection and sealed bearings. Motors shall be the same voltage as the heater. The motor and all wiring shall be totally isolated from the heating chamber for protection from heated air.

**Elements:** Element assemblies shall be constructed of coiled nickel chromium alloy, corrosion resistant wire strung through a minimum of four rows of mica insulator. Element assemblies shall have factory provided connection to allow field modification to 50% wattage at time of installation.

**Thermal Overload:** Heaters shall be equipped with thermal overload Smart Limit Protection®, which disconnects elements and motor in

the event normal operating temperatures are exceeded. If thermal overload trips due to abnormal operating temperatures, thermal overload shall remain open until manually reset by turning the heater off for fifteen minutes. Automatic reset of thermal overloads, which allow the element to continue to cycle under abnormal conditions, will not be accepted.

**Wall Can:** The wall can shall be 22 gauge electrogalvanized steel and shall contain knockouts through which power leads are brought. The wall can shall be provided with a depth gauge, extending the full length of the wall can. The wall can shall be supplied with a factory installed groundwire. Minimum clearance 4" to floors and 6" to sidewalls. Zero clearance to combustibles material in the wall.

**Grille:** The grille shall be a louvered, one-piece design with rounded edges on all four sides, with rounded corners to prevent snags from contact with other materials. The grille shall be epoxy powder-coated in the color specified by the manufacturer.

**Approvals:** cULus (E41422)

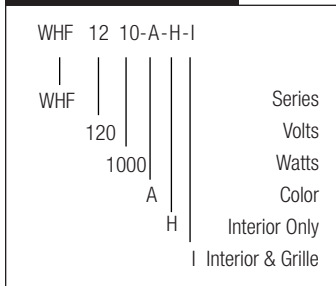
**MODEL CODE:**

Standard Color: Bright White

**ACCESSORIES:**

MODEL	DESCRIPTION	UPC #099319 PART #	WT. (lbs.)
UIC	Recess Wall Can	12640	3.5
UICF	Recess Wall Can with Flange	12540	4
WHSC	Surface Can - White 13½" H x 10½" W x 4" D	19204	4
WHSC-ALMOND	Surface Can - Almond 13½" H x 10½" W x 4" D	19205	4
WHFG	Grille - White	12520	2
WHFG-ALMOND	Grille - Almond	12530	2.5
WHFG17W13H	13" H x 17" W Oversize Grille	12523	3.5
WHT-1	Built-in Single Pole Single Throw Thermostat Kit	12099	.5
WHT-2	Built-in Double Pole Single Throw Thermostat Kit	12102	.5
WHF-DISPLAY	Countertop Display	12011	19

**SELECTION:**

WATTAGE	120V		208V		240V		WT. (lbs.)
	MODEL	UPC #093319 PART #	MODEL	UPC #093319 PART #	MODEL	UPC #093319 PART #	
1000 or 500	WHF1210	12012	WHF2010	12445	WHF2410	12027	8
1200 or 600	WHF1212	12015			WHF2412	12215	
1500 or 750	WHF1215	12018	WHF2015	12447	WHF2415	12033	
2000 or 1000			WHF2020	12453	WHF2420	12036	
2400 or 1200					WHF2424	12039	

**FACTORY INSTALLED OPTIONS**

ADD SUFFIX:	DESCRIPTION	WT. (lbs.)
-A	Almond Color	8
-H	Interior Only (no wall can or grille)	6
-I	Interior and Grille Only (no wall can)	6



WHFG17W13H - 13" H x 17" W Oversize Grille



WHSC - White Surface Can

as shown: WHF2420

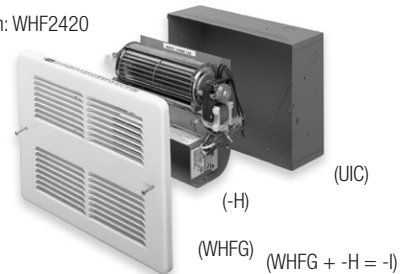

WHF Interior

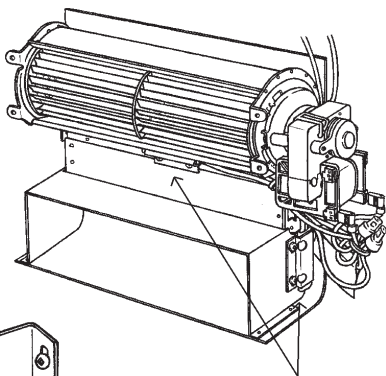
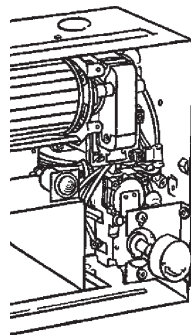
 Double Manual Reset Limit  
SMART LIMIT PROTECTION®

WHF thermostat installed

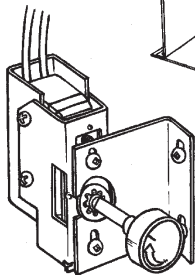

WHT-1 - built-in thermostat kit SPST

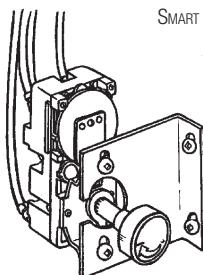

WHT-2 - built-in thermostat kit DPST

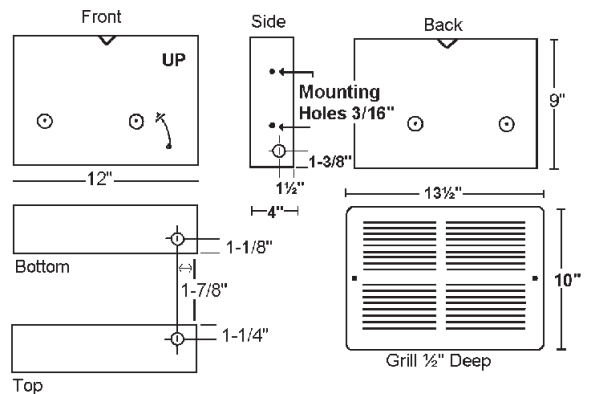
**DIMENSIONS:**

**MINIMUM CLEARANCE:**

 Zero clearance to insulation  
4" above floor  
6" from adjacent wall